

SAK-Series

Catalogue 2009/2010

Product Portfolio

Weidmüller is the leading provider of solutions for electrical connectivity, transmission, conditioning and processing of power, signals and data in industrial environments. The company develops, produces and sells products in the field of electrical connectivity, functional electronics and communication electronics.

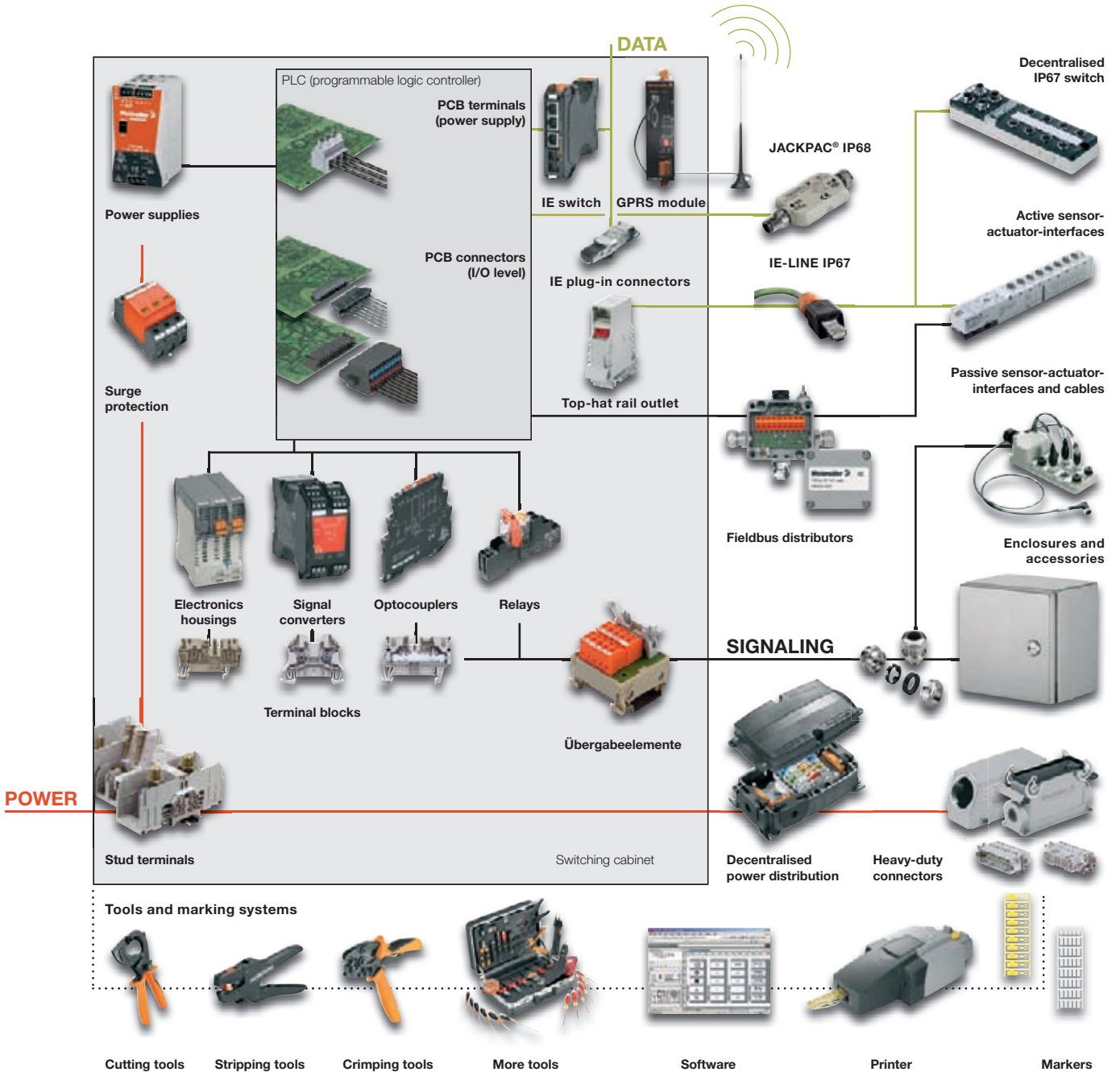

All the catalogues at a glance

Catalogue	Order No.
Catalog 1: Modular Terminal Blocks	566140000
Catalog 2: PCB Terminals, PCB Connectors and Housings for Electronics	565908000
Catalog 3: RockStar® – Heavy Duty Connectors	566424000
Catalog 4: Functional Electronics	566154000
Catalog 5: Enclosures and Cable Glands	566192000
Catalog 6: Tools	566146000
Catalog 7: Marking Systems	566159000
Catalog 8: Sensor Actuator Interface	106733000
Catalog 9: Industrial Ethernet	106718000
Product information on FieldPower® – decentralised power distribution	566122000

SAK-Series	SAK-Series TS 35	A
	SAK-Series TS 32	B
	SAK-Series combination foot TS 35 + TS 32	C
	SAK-Series for special applications	D
	AKZ-Series TS 15	E
	Multi-pole terminal strips	F
	KLBÜ shielded connection	G
	Busbars / Terminal rails	H
	Accessories	I
	Tools and ferrules	J
	Marking systems	K

Appendix	Technical appendix	W
	Index Search according to type or order number, Addresses worldwide	X

“SAK – A real classic that became synonymous with connection technology”



Weidmüller has an interesting story to tell about SAK terminals. SAK (German abbreviation for „side-by-side mountable terminals“) is the designation for a terminal that has proven itself on the market for more than 55 years. Using the side-by-side mounting principal, electrical terminals made of plastic replaced breakable porcelain constructions in switchgear cabinets.

One could as a result say: „SAK was the first family of terminals in the world that helped the electrical industry make a technological breakthrough“.

Further developments of the terminals and passive connection technology form the Weidmüller group’s traditional core business.

SAK wire connections – synonymous with reliable connections and product variety.

This long-term experience in the market enabled many improvements to be made. Nobody can claim that any other terminal on this earth has had as much know-how put into it as the SAK.

A great deal of know-how has been put into the inconspicuous insulating body with „clamping function“ for electrical wires. This is because terminals have to withstand all kinds of unfavourable conditions. The connections system is chosen according to the respective application.

When looked at more closely, the demands made of an allegedly trivial component such as a terminal are considerable. Appropriately, the EN 60 947-7-1 defines terminals and cable connectors as equipment for connecting and joining electrical wires. Terminals can be mounted side-by-side or staggered, have two or several, independently functioning connection points, and are insulated both from one another and their mountings. They are mounted, for example, onto mounting rails.

Or

“Once upon a time there was a company called Weidmüller that created the best terminals in the world using plastic and metal”.

As well as joining the wiring, terminals are also equipped with further functions:

when fitted with markers, terminals make it possible to clearly arrange „electrical installations“. Moreover, they create a defined connection point that can be extended as required. From this point, the wiring is routed to individual devices in the switchgear cabinet or from the switchgear cabinet to the devices. Terminal blocks increase serviceability, because electrical measurements can be carried out on them, targeted circuits can be opened or protected with appropriate protective elements.

Furthermore, cross-connections can be used to distribute potentials.

A clamping yoke system is used for securing the wiring in SAK terminals (see figure 1). The tension clamp system optimally combines the specific features of steel and copper. This system has proven itself millions of times over in electrical installations: in rough and aggressive industrial atmospheres, in power stations, ships and railway vehicles as well as in building automation.

The clamping yoke and the terminal screw used in Weidmüller’s clamping yoke system are made from case-hardened steel.

The clamping yoke unit with a highstrength terminal screw produces the required contact force and presses the conductor against the busbar, which is made either of copper or high-quality brass. The latter being tin coated.

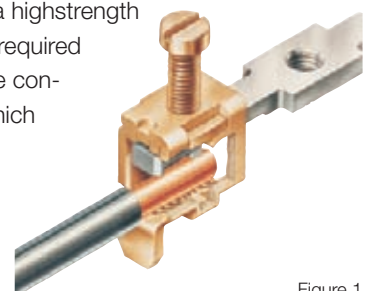

Figure 1

High contact forces with the patented connection system



This ensures a „close fitting” and permanent contact with a low contact resistance. A gas-tight, vibration-resistant connection is created between the conductor and the busbar.

Because even a very good electrically conducting material is only as good as the contact force applied. Weidmüller's patented connection system guarantees high contact forces. This means that it is predestined for use in corrosion-promoting environments; in addition, it is maintenance free. A further aspect is mounting and maintenance on an international scale, made possible by the world-renowned screw connection. One decisive factor for a perfect terminal is the insulating material.

In order to meet the demands placed on terminals, it is necessary to use different insulating materials that are tailor-made for the application – thermoplastic or thermosetting plastic. All insulating materials used by Weidmüller are free from noxious substances and contain no paint pigments based on cadmium. The SAK family especially offers the option of specifically coordinating the terminals with material requirements in mind. In this case, Weidmüller offers the same construction with different insulation materials.

Plastics for terminals – thermoplastics and thermosetting plastics

Thermal plastics are a polyamide (PA), and are one of the most frequently used technical plastics. The advantage of this material is its good electrical and mechanical characteristics, its flexibility and its lack of fracture susceptibility. In addition, this material offers good fire resistance due to its chemical structure without the need for added flameproofing substances. Engineers speak of a so-called „inherent flame protection”. The continuous operating temperature of the SAK range is 100 °C, and at the same time offering V2 fire resistance according to UL 94.

Thermosetting plastics possess high dimensional stability, absorb a negligible amount of water, have a very high tracking resistance and excellent fire resistance. The continuous operating temperature is higher in comparison with that of thermoplastics. With increased thermal load, the dimensional stability of thermosetting plastics is better than that of thermoplastics. Their disadvantage: Thermosetting plastics have less flexibility in comparison with thermoplastics.

A further advantage of the SAK family is the large choice of different locking mechanisms. Its mounting rail designs (MR) offer the user the highest possible degree of convenience: TS 35 and TS 32 as well as a combi foot.

Technical background to the screw connection

A spring element forms the basis for Weidmüller's clamping yoke. Turning the terminal screw expands the upper flank of thread slightly, and in so doing locks itself in position. This construction efficiently compensates all expansions in the diameter of the wire (temperature fluctuations).

This has the following advantages:
of course the terminals age when in use; nevertheless, the terminal point does not yield. Consequently, it is not necessary to retighten the terminal screw at a later date nor does the wire become loose: it is resistant to vibration.

The voltage drop remains consistently low.
Weidmüller's technology is completely maintenance free.

Separating the electrical and mechanical functions means that we use steel for a high contact force, and the good electrical conducting properties of copper for a low voltage drop.

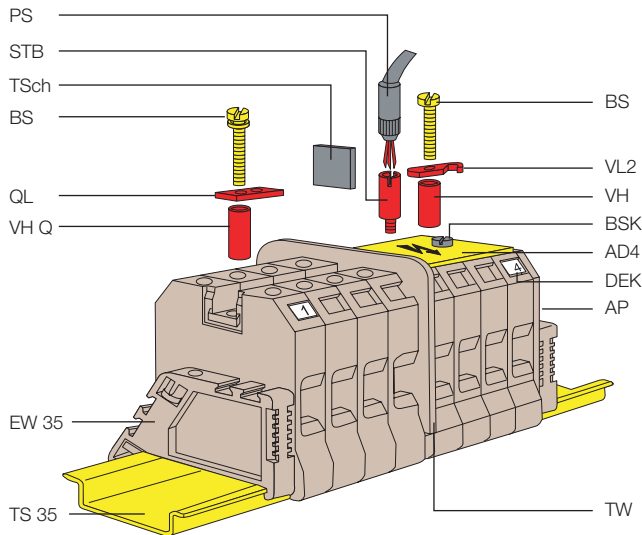

Legend

PS	Test plug
STB	Test socket screw
TSch	Small partition
BS	Fixing screw
QL	Cross-connection link
VH Q	Connection sleeve
EW 35	End brackets
TS 35	Mounting rail
VL	Connection link
BSK	Fixing screw
AD 4	Cover
DEK	Markers
AP	End plate
TW	Partition

The construction of the clamping yoke has been designed in such a manner to ensure that the connection between the wire and the busbar is gas-tight. The surface of the connection must make up at least 75 % of the surface as a whole. Electricity is conducted with 100 % efficiency at these points, because increased resistances due to soiling of the connection points do not arise. The SAK family is designed for wire cross-sections from 0.08 mm² to 240 mm².

A rundown on the SAK:

- PA 6.6, KrG
Two different materials that can be used, depending on the application, at 100 °C or 130 °C.
- Three different types of clip-on foot for mounting rail designs 32, 35 or a combination of both.
- Maintenance free and vibration-resistant There is no need to check the terminal point, because the patented clamping yoke construction ensures that the screws remain captive in the terminal.

Separating the tasks completed by the components offers the following advantages:

- Low voltage drop and gas-tight enclosed (electrical components).
Perfect busbars in combination with a special surface treatment in conjunction with a high interference-fit at the terminal point.
- High contact forces, not reliant on the cross-section (mechanical components).
The clamping yoke is made of casehardened steel that, due to its design, can compensate any dimensional instability of the electrical wire.

SAK-Series

The advantages of all SAK modular terminals:

- Separation of electrical and mechanical functions:
 - steel clamping yoke for the mechanical function
 - copper busbar for the electrical function
- Maintenance-free and vibration-proof screw connection
- Low voltage drop and gas-tight contact point
- High contact forces, not reliant on the cross-section
- Three different clip-on foot designs available
- Various insulation materials
- Large selection of special terminals with diverse connection systems
- Large range of accessories available

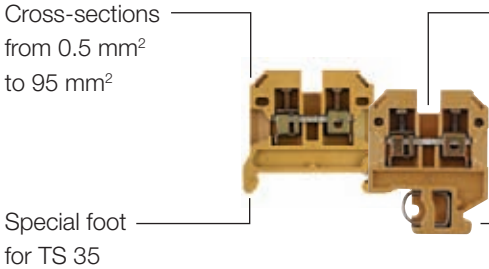
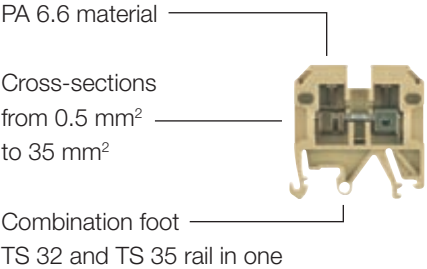
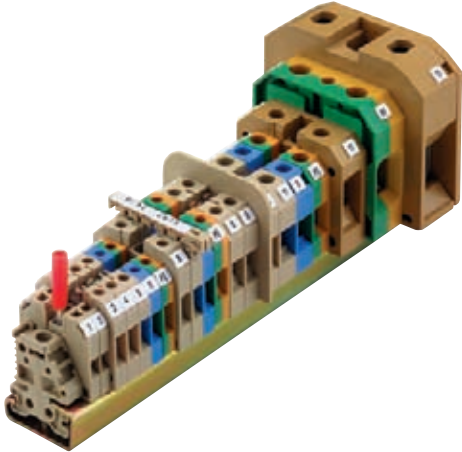

Temperature ranges and materials
 100 °C – PA 6.6
 130 °C – KrG
 Special foot for TS 32

Product range

Clamp type	Rated cross-section						Flat blade connection	Push-on connection	Spring connection	Solder connection
	2.5 mm ²	4 mm ²	6 mm ²	10 mm ²	16 mm ²	35 mm ²				
Modular feed-through terminals										
PA 6.6 / TS 32	•	•	•	•	•	•		•	•	•
KRG / TS 32	•	•	•	•	•	•	•	•	•	•
PA 6.6 / TS 35	•	•	•	•	•	•		•	•	•
KRG / TS 35	•	•	•	•	•	•	•			
PA 6.6 / comb. foot	•	•	•	•	•	•				
PA 6.6 / TS 15	•	•						•		•
Modular 2-tier terminals		•								
Modular PE terminals										
PA 6.6 / TS 32	•	•		•	•	•				
PA 6.6 / TS 35	•	•	•	•	•	•				
PA 6.6 / TS 15	•	•								
Modular fuse terminals										
PA 6.6 / TS 32				•						
PA 6.6 / TS 35				•						
KrG / TS 32				•	•					
KrG / TS 35				•	•					
PA 6.6 / TS 15		•								
PA 6.6 / comb. foot		•								
Modular 2-tier fuse terminals										
PA 6.6 / TS 32		•								
PA 6.6 / TS 35		•								
PA 6.6 / comb. foot		•								
Modular disconnect terminals										
TS 35		•		•						
PA 6.6 / TS 15		•								
Modular 2-tier disconnect terminals		•						•		
Modular ceramic terminals		•		•						

SAK-Series TS 35

SAK-Series TS 35	
Feed-through modular terminals	
TS 35 / PA	A.2
TS 35 / KrG	A.7
Terminals with spring-loaded cable clamps	
TS 35 / PA	A.11
Two-tier modular terminals	
TS 35 / PA	A.12
Modular PE terminals	
TS 35 / PA	A.14
Disconnect terminals	
TS 35 / PA	A.18
TS 35 / KrG	A.20
Fuse terminals	
TS 35 / PA	A.22
TS 35 / KrG	A.24
Fuse inserts and gauge rings for Weidmüller fuse terminals	A.28
Installation terminals	
TS 35 / PA	A.30
Test-disconnect terminals	
TS 35 / KrG	A.32
Terminals for temperature measuring circuits	
TS 35 / PA	A.34
Terminals with screw-less connections	
With tab connection TS 35 / PA	A.36
With solder connection TS 35 / PA	A.40
Special terminals – SAKG	
TS 35 / KrG	A.42
Stud Terminal – KST	
TS 35 / PA	A.48
Terminals with electronic components	
TS 35 / PA	A.50
Earth conductor isolating terminals	A.57

Feed-through modular terminals

TS 35 / PA

Width/Length/height with TS35x7.5	mm
max. current / max. cond. cross-section	A/mm ²
Max. clamping range	mm ²

Technical data

Rated data	
Rated voltage	V
Rated current	A
Rated cross-section	mm ²
Rated impulse voltage / Pollution severity	kV/-
Gauge to IEC 60947-1 / UL94 Flammability class	
Approvals	
Clamped conductors (H05V/H07V)	
solid / stranded	mm ²
flexible / Stranded wire with end ferrules	mm ²
Tightening torque range (clamping screw)	
Stripping length / Blade size	mm/-
2 conductors with same cross-section (H05V/H07V)	
solid / stranded	mm ²
flexible / Stranded wire with end ferrules	mm ²
Note	

Ordering data

Version	
	beige
	Blue
Note	

Accessories

Screwable cross-connection	
	2-pole
	3-pole
	4-pole
	10-pole
	Connecting sleeve
	Mounting screw
	Lock washer
Switchable link	
	Switchable link
	Connecting sleeve
	Mounting screw
Testing / Checking	
	Test plug
	Socket
End plate / Partition plate	
	beige
	Blue
	beige
	Blue
Small partition	
	Small partition
Cover / warning label	
	Cover / warning label
	Mounting screw (plastic)
Marking systems (see assortment in catalogue 7)	
	Marking tags
For detailed information on other accessories and applications, refer to the „Accessories“ section	

SAKD 2.5/35

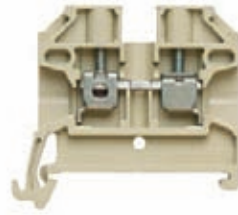
2.5 mm²

5 x 44 x 38
30 / 4
0.33...4

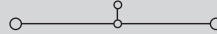

IEC 60947-7-1

IEC	UL	CSA
500	300	300
24	20	20
2.5	AWG 22...12	AWG 22...12
6 / 3		
A2 / V2		

Rated connection

0.5...4 / 0.5...4
0.5...4 / 0.5...2.5
0.4...0.6 Nm (M 2.5)
10 / 0.6 x 3.5 mm

0.5...0.75	mm ²
0.5...0.75 / 0.5...0.75	mm ²

With twin ferrules ZH 0.5 to ZH 1.5, rated voltage is 690 V.

Type	Qty.	Order No.
SAKD 2.5/35	100	0268860000
SAKD 2.5/35 BL	100	0268880000

Type	current	Qty.	Order No.
Q 2 SAKD2.5N	24 A	50	0367800000
Q 3 SAKD2.5N	24 A	50	0367900000
Q 4 SAKD2.5N	24 A	50	0368000000
Q 10 SAKD2.5N	24 A	20	0368100000

	Width		
PS 2.3 RT	5.4 mm	20	0180400000
STB 8.5/D4/2.3/M2.5 AKZ		50	0215700000

AP SAKD2.5N	1.5 mm	20	0150960000
AP SAKD2.5N BL	1.5 mm	20	0150980000
TW SAKD2.5N	1.5 mm	20	0191860000
TW SAKD2.5N BL	1.5 mm	20	0191880000

TSCH 3 SAKD2.5 N	5 mm	100	0366860000
------------------	------	-----	-------------------

DEK 5/5 / SCHT 7

SAK 2.5

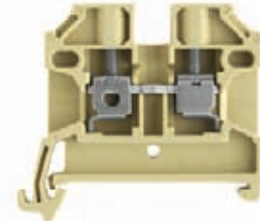
2.5 mm²

6.1 x 44.5 x 40
41 / 6
0.13...6

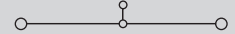

IEC 60947-7-1

Ex ell II 2 G D

IEC	UL	CSA	EN 60079-7
800	600	600	550
24	20	25	21
2.5	AWG 22...12	AWG 26...10	2.5
8 / 3			
A3 / V2			

KEMA 97ATEX1798 U

Rated connection

0.5...6 / 0.5...4
0.5...4 / 0.5...4
0.4...0.6 Nm (M 2.5)
10 / 0.6 x 3.5 mm

With twin ferrules ZH 0.5 to ZH 1.5, rated voltage is 690 V.

Type	Qty.	Order No.
SAK 2.5/35	100	0380460000
SAK 2.5/35 BL	100	0380480000

Type	current	Qty.	Order No.
Q 2 SAK2.5	41 A	50	0337000000
Q 3 SAK2.5	41 A	50	0337100000
Q 4 SAK2.5	41 A	50	0337200000
Q 10 SAK2.5	41 A	20	0368700000

	Width		
PS 2.3 RT	5.4 mm	20	0180400000
STB 8.5/5/2.3/M3 SAK2.5		50	0280600000

AP SAK2.5	1.5 mm	20	0279560000
AP SAK2.5 BL	1.5 mm	20	0279580000
TW SAK2.5	2.5 mm	20	0302860000
TW SAK2.5 BL	1.5 mm	20	0302880000

TSCH 1	2 mm	100	0319160000
--------	------	-----	-------------------

AD 3 SAK2.5		50	0297900000
BFSC M3x22 PA/RT		100	0128900000

DEK 5/6 / SCHT 7

SAK 4

4 mm²



6.5 x 45 x 44
41 / 6
0.13...6

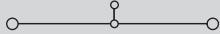

IEC 60947-7-1 Ex e ll II 2 G D

IEC	UL	CSA	EN 60079-7
800	600	600	550
32	30	36	28
4	AWG 22...12	AWG 26...10	4
8 / 3			
A4 / V2			

KEMA 97ATEX1798 U

Rated connection

0.5...6 / 0.5...4
0.5...4 / 0.5...4
0.5...1.0 Nm (M 3)
12 / 0.6 x 3.5 mm

1.5...1.5
0.5...1.5

With twin ferrules ZH 0.5 to ZH 2.5, rated voltage is 690 V.

Type	Qty.	Order No.
SAK 4/35	100	0443660000
SAK 4/35 BL	100	0443680000

Type	current	Qty.	Order No.
Q 2 SAK4	41 A	50	0336700000
Q 3 SAK4	41 A	50	0336800000
Q 4 SAK4	41 A	50	0336900000
Q 10 SAK4	41 A	20	0368800000
VL 2 SAK4	32 A	50	0197000000
VH 19/5/3.5 SAK4-16		50	0285100000
BFSC M3X25		100	0292500000
Width			
PS 4 F.STB 4	7.6 mm	20	0299600000
STB 14/D5/2.3/M3 SAK2.5		50	0168600000
AP SAK4-10	1.5 mm	20	0117960000
AP SAK4-10 BL	1.5 mm	20	0117980000
TW 4 SAK4-10	1.5 mm	20	0130160000
TW 4 SAK4-10 BL	1.5 mm	20	0130180000
TSCH 1	2 mm	100	0319160000
AD 4 SAK4		50	0285300000
BFSC M3X22 PA/RT		100	0128900000

DEK 5/6.5 / SCHAT 7

SAK 6

6 mm²

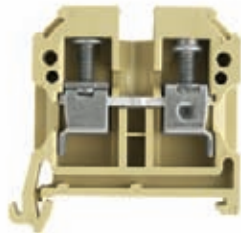

8 x 45 x 44
57 / 10
0.33...10

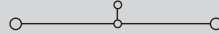

IEC 60947-7-1 Ex e ll II 2 G D

IEC	UL	CSA	EN 60079-7
800	600	600	550
41	40	47	36
6	AWG 22...8	AWG 20...8	6
8 / 3			
A5 / V2			

KEMA 97ATEX1798 U

Rated connection

0.5...10 / 0.5...6
0.5...10 / 0.5...6
0.8...1.6 Nm (M 3.5)
12 / 4.0 x 0.8 mm

For AWG 8-7 and AWG 8-19, tightening torque is 1.21.4 Nm

Type	Qty.	Order No.
SAK 6/35 PA	100	0380560000
SAK 6/35 PA/BL	100	0380580000

With AWG 6 and H07V-R10 conductors, an increased MD torque of 1.4 to 1.6 Nm should be used.

Type	current	Qty.	Order No.
Q 2 SAK6N	32 A	50	0456700000
Q 3 SAK6N	57 A	50	0456800000
Q 4 SAK6N	57 A	50	0456900000
Q 10 SAK6N	32 A	20	0457000000
VL 2 SAK6N/SAKT	32 A	50	0194700000
VH 19/5/3.5 SAK4-16		50	0285100000
BFSC M3X25		100	0292500000
Width			
PS 4 F.STB 4	7.6 mm	20	0299600000
STB 14/D6/4/M3 SAK10		50	0169900000
AP SAK4-10	1.5 mm	20	0117960000
AP SAK4-10 BL	1.5 mm	20	0117980000
TW 4 SAK4-10	1.5 mm	20	0130160000
TW 4 SAK4-10 BL	1.5 mm	20	0130180000
TSCH 1	2 mm	100	0319160000
AD 4 SAK6N		50	0196600000
BFSC M3X22 PA/RT		100	0128900000

DEK 5/8 / SCHAT 7

When used with twin ferrules ZH 0.5 - ZH 4, the rated voltage is 690 V.

SAK 10

10 mm²

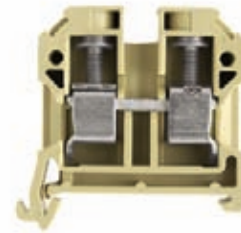

10 x 45 x 51.5
76 / 16
1.5...16

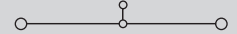

IEC 60947-7-1 Ex e ll II 2 G D

IEC	UL	CSA	EN 60079-7
800	600	600	550
57	60	65	50
10	AWG 14...6	AWG 16...6	10
8 / 3			
B6 / V2			

KEMA 97ATEX1798 U

Rated connection

1.5...10 / 1.5...16
1.5...16 / 1.5...10
2.0...4.0 Nm (M 4)
12 / 1.0 x 5.5 mm

When used with twin ferrules ZH 0.5 - ZH 4, the rated voltage is 690 V.

Type	Qty.	Order No.
SAK 10/35	100	0443760000
SAK 10/35 BL	100	0443780000

A higher torque of 2 to 2.4 Nm is necessary when using H07V-R16 and AWG 6 conductors.

Type	current	Qty.	Order No.
Q 2 SAK10	57 A	50	0457100000
Q 3 SAK10	57 A	50	0457200000
Q 4 SAK10	57 A	50	0457300000
Q 10 SAK10	57 A	20	0457400000
VL 2 SAK6/10/SAKB	32 A	50	0135900000
VH 19/5/3.5 SAK4-16		50	0285100000
BFSC M3X25		100	0292500000
Width			
PS 4 F.STB 4	7.6 mm	20	0299600000
STB 14/D6/4/M3 SAK10		50	0169900000
AP SAK4-10	1.5 mm	20	0117960000
AP SAK4-10 BL	1.5 mm	20	0117980000
TW 4 SAK4-10	1.5 mm	20	0130160000
TW 4 SAK4-10 BL	1.5 mm	20	0130180000
TSCH 1	2 mm	100	0319160000
AD 4 SAK10		50	0178600000
BFSC M3X22 PA/RT		100	0128900000

DEK 5/5

Feed-through modular terminals

TS 35 / PA

In hazardous area applications, the installation instructions and the rated data specifications for accessories given in the technical appendix must be followed.

Width/Length/height with TS35x7.5	mm
max. current / max. cond. cross-section	A/mm ²
Max. clamping range	mm ²

Technical data

Rated data	
Rated voltage	V
Rated current	A
Rated cross-section	mm ²
Rated impulse voltage / Pollution severity	kV/-
Gauge to IEC 60947-1 / UL94 Flammability class	
Approvals	
Clamped conductors (H05V/H07V)	
solid / stranded	mm ²
flexible / Stranded wire with end ferrules	mm ²
Tightening torque range (clamping screw)	
Stripping length / Blade size	mm/-
2 conductors with same cross-section (H05V/H07V)	
solid / stranded	mm ²
flexible / Stranded wire with end ferrules	mm ²
Note	

Ordering data

Version	
	beige
	Blue
Note	

Accessories

Screwable cross-connection	
	2-pole
	3-pole
	4-pole
	10-pole
	Connecting sleeve
	Mounting screw
	Lock washer
Switchable link	
	Switchable link
	Connecting sleeve
	Mounting screw
Testing / Checking	
	Test plug
	Socket
End plate / Partition plate	
	beige
	Blue
	beige
	Blue
Small partition	
	Small partition
Cover / warning label	
	Cover / warning label
	Mounting screw (plastic)
Marking systems	
	(see assortment in catalogue 7)
	Marking tags
For detailed information on other accessories and applications, refer to the „Accessories“ section	

SAK 16



16 mm²

12 x 50 x 57.5

76 / 16

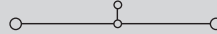
2.5...16



IEC 60947-7-1				Ex e ll  ll 2 G D			
IEC	UL	CSA	EN 60079-7	IEC	UL	CSA	EN 60079-7
1000	600	600	690	1000	600	600	690
76	80	87	66	125	105	145	109
16	AWG 12...4	AWG 14...6	16	35	AWG 12...2	AWG 12...2	35
				8 / 3			
				B6 / V2			
				KEMA 97ATEX1798 U			
Rated connection							
2.5...16 / 4...16							
4...16 / 4...16							
2.0...4.0 Nm (M 4)							
15 / 1.0 x 5.5 mm							
Note							
Twin wire end ferrules ZH 2.5 - ZH 16 can be used.							

Type	Qty.	Order No.
SAK 16/35 PA	50	0380660000
SAK 16/35 PA/BL	50	0380680000
If QIs are aligned side by side, then a TW/AP must be used.		

Type	current	Qty.	Order No.
Q 2 SAK16	76 A	50	0457500000
Q 3 SAK16	76 A	50	0457600000
Q 4 SAK16	76 A	50	0457700000
Q 10 SAK16	76 A	20	0457800000
Width			
PS 4 F.STB 4	7.6 mm	20	0299600000
STB 14/D6/4/M3 SAK10	50	0169900000	
VL 2 SAK16/SAKA	57 A	50	0135800000
VH 19/5/3.5 SAK4-16	50	0285100000	
BFSC M3X25	100	0292500000	
Width			
PS 4 F.STB 4	7.6 mm	20	0299600000
STB 16/D7/4/M4 SAK35	50	0140200000	
AP SAK16	1.5 mm	20	0271160000
AP SAK16 BL	1.5 mm	20	0271180000
TSCH 1	2 mm	100	0319160000
AD 4 SAK16	50	0518200000	
BFSC M3X22 PA/RT	100	0128900000	
DEK 5/5			

SAK 35/35



35 mm²

18 x 58 x 60

150 / 50

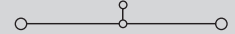
2.5...50



IEC 60947-7-1				Ex e ll  ll 2 G D			
IEC	UL	CSA	EN 60079-7	IEC	UL	CSA	EN 60079-7
1000	600	600	550	1000	600	600	550
125	105	145	109	125	105	145	109
35	AWG 12...2	AWG 12...2	35	35	AWG 12...2	AWG 12...2	35
				8 / 3			
				B8 / V2			
				KEMA 97ATEX1798 U			
Rated connection							
2.5...16 / 4...50							
2.5...35 / 2.5...35							
4.0...5.0 Nm (M 6)							
18 / 6.5 x 1.2 mm							
2.5...10 / 10...16							
2.5...16 / 2.5...16							
Note							
The tightening torque is 4.5 Nm for 16 - 50 mm ² and AWG 6 - 2/7 stranded conductors. Twin wire end ferrules ZH 2.5 - ZH 16 can be used.							

Type	Qty.	Order No.
SAK 35/35	20	0380760000
SAK 35/35 BL	20	0380780000
It is possible to use twin ferrules with identical rated voltages (LAB 13090).		

Type	current	Qty.	Order No.
QL 2 SAK35	110 A	20	0123600000
QL 3 SAK35	110 A	20	0123700000
QL 4 SAK35	110 A	20	0123800000
QL 10 SAK35	110 A	20	0338600000
VH 17/8/5 SAK35	50	0267000000	
BFSC M4X30	50	0267100000	
SS M4 D 128-A 4	100	0136400000	
VL 2 SAK35	50	0124000000	
VH 24.5/8/5 SAK35	50	0298700000	
BFSC M4X35	50	0298900000	
Width			
PS 4 F.STB 4	7.6 mm	20	0299600000
STB 16/D7/4/M4 SAK35	50	0140200000	
AP SAK35/TW SAK16	1.5 mm	10	0303660000
AP SAK35/TW SAK16 BL	1.5 mm	10	0303680000
TW SAK35	1.5 mm	20	0304360000
AD 4 SAK35	50	0178700000	
BFSC M4X32 PA/RT	100	0129100000	
DEK 5/5 / SCHT 7			
If QIs are aligned side by side, then a TW/AP must be used.			

SAK 35/35/IK

35 mm²

Hexagon socket head screw



18 x 58 x 60
150 / 50
2.5...50

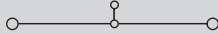

IEC 60947-7-1 Ex e II II 2 G D

IEC	UL	CSA	EN 60079-7
1000	600	600	550
125	105	145	109
35	AWG 12...2	AWG 12...2	35
8 / 3			
B8 / V2			

KEMA 97ATEX1798 U

Rated connection

2.5...16 / 4...50
2.5...35 / 2.5...35
4.0...6.0 Nm (M 6)
18 / S4 (DIN 6911)

2.5...10 / 10...16
2.5...16 / 2.5...16

The tightening torque is 4.5 Nm for 16 - 50 mm² and AWG 6 - 2/7 stranded conductors. Twin wire end ferrules ZH 2.5 - ZH 16 can be used.

Type	Qty.	Order No.
SAK 35/35/IK	20	0582460000

It is possible to use twin ferrules with identical rated voltages (LAB 13090).

SAK 35N/35

35 mm²

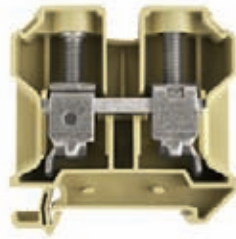

16 x 58 x 60
150 / 50
2.5...50

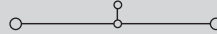

IEC 60947-7-1

IEC	UL	CSA
1000	600	600
125	105	120
35	AWG 12...2	AWG 12...2
8 / 3		
B8 / V2		

Rated connection

2.5...16 / 4...50
2.5...35 / 1.5...35
4.0...5.0 Nm (M 6)
18 / 6.5 x 1.2 mm

2.5...10 / 10...16
2.5...16 / 2.5...16

The tightening torque is 4.5 Nm for 16 - 50 mm² and AWG 6 - 2/7 stranded conductors. Twin wire end ferrules ZH 2.5 - ZH 16 can be used.

Type	Qty.	Order No.
SAK 35N/35	20	0608260000

It is possible to use twin ferrules with identical rated voltages (LAB 13090).

SAK 35N/35/IK

35 mm²

Hexagon socket head screw

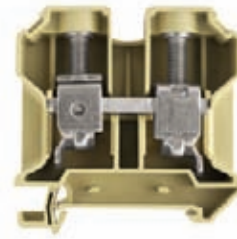

16 x 58 x 60
150 / 50
2.5...50

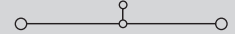

IEC 60947-7-1

IEC	UL	CSA
1000	600	600
125	105	120
35	AWG 12...2	AWG 12...2
8 / 3		
B8 / V2		

Rated connection

2.5...16 / 4...50
2.5...35 / 1.5...35
4.0...6.0 Nm (M 6)
18 / S4 (DIN 6911)

2.5...10 / 10...16
2.5...16 / 2.5...16

The tightening torque is 4.5 Nm for 16 - 50 mm² and AWG 6 - 2/7 stranded conductors. Twin wire end ferrules ZH 2.5 - ZH 16 can be used.

Type	Qty.	Order No.
SAK 35N/35/IK	20	0608360000

It is possible to use twin ferrules with identical rated voltages (LAB 13090).

Type	current	Qty.	Order No.
QL 2 SAK35	99 A	20	0123600000
QL 3 SAK35	99 A	20	0123700000
QL 4 SAK35	99 A	20	0123800000
QL 10 SAK35	99 A	20	0338600000
VH 17/8/5 SAK35	50	50	0267000000
BFSC M4X30	50	50	0267100000
SS M4 D 128-A 4	100	100	0136400000
Width			
PS 4 F.STB 4	7.6 mm	20	0299600000
STB 16/D7/4/M4 SAK35	50	50	0140200000
AP SAK35/TW SAK16	1.5 mm	10	0303660000
AP SAK35/TW SAK16 BL	1.5 mm	10	0303680000
TW SAK35	1.5 mm	20	0304360000
Width			
AD 4 SAK35	50	50	0178700000
BFSC M4X32 PA/RT	100	100	0129100000

DEK 5/5
If QIs are aligned side by side, then a TW/AP must be used.

Type	current	Qty.	Order No.
QL 2 SAK35N	110 A	50	0564900000
QL 3 SAK35N	110 A	50	0565000000
QL 4 SAK35N	110 A	50	0565100000
QL 10 SAK35N	110 A	20	0565200000
VH 17/8/5 SAK35	50	50	0267000000
BFSC M4X30	50	50	0267100000
SS M4 D 128-A 4	100	100	0136400000
Width			
PS 4 F.STB 4	7.6 mm	20	0299600000
STB 16/D7/4/M4 SAK35	50	50	0140200000
AP SAK35/TW SAK16	1.5 mm	10	0303660000
AP SAK35/TW SAK16 BL	1.5 mm	10	0303680000
TW SAK35	1.5 mm	20	0304360000
Width			
AD 4 SAK35N	50	50	0576700000
BFSC M4X32 PA/RT	100	100	0129100000

DEK 5/5
If QIs are aligned side by side, then a TW/AP must be used.

Type	current	Qty.	Order No.
QL 2 SAK35N	99 A	50	0564900000
QL 3 SAK35N	99 A	50	0565000000
QL 4 SAK35N	99 A	50	0565100000
QL 10 SAK35N	99 A	20	0565200000
VH 17/8/5 SAK35	50	50	0267000000
BFSC M4X30	50	50	0267100000
SS M4 D 128-A 4	100	100	0136400000
Width			
PS 4 F.STB 4	7.6 mm	20	0299600000
STB 16/D7/4/M4 SAK35	50	50	0140200000
AP SAK35/TW SAK16	1.5 mm	10	0303660000
AP SAK35/TW SAK16 BL	1.5 mm	10	0303680000
TW SAK35	1.5 mm	20	0304360000
Width			
AD 4 SAK35N	50	50	0576700000
BFSC M4X32 PA/RT	100	100	0129100000

DEK 5/5
If QIs are aligned side by side, then a TW/AP must be used.

Feed-through modular terminals

TS 35 / PA

In hazardous area applications, the installation instructions and the rated data specifications for accessories given in the technical appendix must be followed.

Width/Length/height with TS35x7.5	mm
max. current / max. cond. cross-section	A/mm ²
Max. clamping range	mm ²

Technical data

Rated data	
Rated voltage	V
Rated current	A
Rated cross-section	mm ²
Rated impulse voltage / Pollution severity	kV/-
Gauge to IEC 60947-1 / UL94 Flammability class	
Approvals	
Clamped conductors (H05V/H07V)	
solid / stranded	mm ²
flexible / Stranded wire with end ferrules	mm ²
Tightening torque range (clamping screw)	
Stripping length / Blade size	mm/-
2 conductors with same cross-section (H05V/H07V)	
solid / stranded	mm ²
flexible / Stranded wire with end ferrules	mm ²
Note	

Ordering data

Version	
	beige
	Blue
Note	

Accessories

Screwable cross-connection	
	2-pole
	3-pole
	4-pole
	10-pole
	Connecting sleeve
	Mounting screw
	Lock washer
Switchable link	
	Switchable link
	Connecting sleeve
	Mounting screw
Testing / Checking	
	Test plug
	Socket
End plate / Partition plate	
	beige
	Blue
	beige
	Blue
Small partition	
	Small partition
Cover / warning label	
	Cover / warning label
	Mounting screw (plastic)
Marking systems	
	(see assortment in catalogue 7)
	Marking tags
For detailed information on other accessories and applications, refer to the „Accessories“ section	

SAK 70/35

70 mm²

22 x 75 x 87

192 / 70

16...70

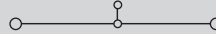

IEC 60947-7-1

IEC	UL	CSA
1000	600	600
192	150	150
70	AWG 4...2/0	AWG 4...2/0
	8 / 3	
	B11 / V2	

Rated connection

16...16 / 16...70
16...70 / 16...35
6.0...12 Nm (M 8)
24 / S6 (DIN 6911)

Tightening torque for 70 mm² stranded = 12 Nm.

Type	Qty.	Order No.
SAK 70/35	10	0139160000

Type	current	Qty.	Order No.
QL 2 SAK70	192 A	20	0345300000
QL 3 SAK70	192 A	5	0167000000
VH 30.5/11/5.5 SAK70		20	0345500000
BFSC M5X45		20	0345600000
SS M5 D 128-A 5		50	0346100000
Width			
PS 4 F.STB 4	7.6 mm	20	0299600000
STB 16/D7/4/M5 SAK70		50	0385400000
AP SAK70/35	2 mm	10	0340960000
AD 3 SAK70		10	0344300000
BFSC M5X45 PA/NA		50	0344400000
DEK 5/5			

TS 35 / KrG

In hazardous area applications, the installation instructions and the rated data specifications for accessories given in the technical appendix must be followed.

Width/Length/height with TS35x7.5	mm
max. current / max. cond. cross-section	A/mm ²
Max. clamping range	mm ²

Technical data

Rated data	
Rated voltage	V
Rated current	A
Rated cross-section	mm ²
Rated impulse voltage / Pollution severity	kV/-
Gauge to IEC 60947-1 / UL94 Flammability class	
Approvals	
Clamped conductors (H05V/H07V)	
solid / stranded	mm ²
flexible / Stranded wire with end ferrules	mm ²
Tightening torque range (clamping screw)	
Stripping length / Blade size	mm/-
Note	

Ordering data

Version	
	Medium yellow
	Blue
Note	

Accessories

Screwable cross-connection	
	2-pole
	3-pole
	4-pole
	10-pole
	Connecting sleeve
	Mounting screw
	Lock washer
Switchable link	
	Switchable link
	Connecting sleeve
	Mounting screw
Testing / Checking	
	Test plug
	Socket
End plate / Partition plate	
	Medium yellow
	Blue
	Medium yellow
	Blue
Small partition	
	Small partition
Cover / warning label	
	Cover / warning label
	Mounting screw (plastic)
Marking systems	
	(see assortment in catalogue 7)
	Marking tags
For detailed information on other accessories and applications, refer to the „Accessories“ section	



SAK 2.5

2.5 mm²

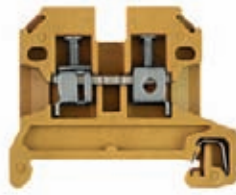

6.1 x 49.5 x 40
32 / 6
0.13...6

IEC 60947-7-1				Ex e ll Ex II 2 G D			
IEC	UL	CSA	EN 60079-7	IEC	UL	CSA	EN 60079-7
800	600	600	550	800	600	600	550
24	20	25	21	32	30	36	28
2.5	AWG 22...12	AWG 26...10	2.5	4	AWG 22...12	AWG 26...10	4
				8 / 3			
				A3 / 5VA			
				KEMA 97ATEX1798 U			
Rated connection							
0.5...6 / 0.5...4							
0.5...4 / 0.5...2.5							
0.4...0.6 Nm (M 2.5)							
10 / 0.6 x 3.5 mm							
With twin ferrules ZH 0.5 to ZH 1.5, rated voltage is 690 V.							

Type	Qty.	Order No.
SAK 2.5/35 KRG	100	0380420000
SAK 2.5/35 KRG/BL	100	0380470000

Type	current	Qty.	Order No.
Q 2 SAK2.5	41 A	50	0337000000
Q 3 SAK2.5	41 A	50	0337100000
Q 4 SAK2.5	41 A	50	0337200000
Q 10 SAK2.5	41 A	20	0368700000
Width			
PS 2.3 RT	5.4 mm	20	0180400000
STB 8.5/5/2.3/M3 SAK2.5		50	0280600000
AP SAK2.5 KRG	1.5 mm	20	0279520000
AP SAK2.5 KRG BL	1.5 mm	20	0279570000
TW SAK2.5 KRG	2.5 mm	20	0302820000
TW SAK2.5 KRG/BL	2.5 mm	20	0302870000
TSCH 1	2 mm	100	0319160000
AD 4 AKZ4		50	0303400000
BFSC M3X22 PA/RT		100	0128900000

DEK 5/6 / SCHT 7

SAK 4

4 mm²



6.5 x 45 x 44
41 / 6
0.13...6

IEC 60947-7-1				Ex e ll Ex II 2 G D			
IEC	UL	CSA	EN 60079-7	IEC	UL	CSA	EN 60079-7
800	600	600	550	800	600	600	550
32	30	36	28	41	30	36	28
4	AWG 22...12	AWG 26...10	4	4	AWG 22...12	AWG 26...10	4
				8 / 3			
				A4 / 5VA			
				KEMA 97ATEX1798 U			
Rated connection							
0.5...6 / 0.5...4							
0.5...4 / 0.5...4							
0.5...1.0 Nm (M 3)							
12 / 0.6 x 3.5 mm							
With twin ferrules ZH 0.5 to ZH 2.5, rated voltage is 690 V.							

Type	Qty.	Order No.
SAK 4/35 KRG	100	0443620000
SAK 4/35 KRG/BL	100	0443670000

Type	current	Qty.	Order No.
Q 2 SAK4	41 A	50	0336700000
Q 3 SAK4	41 A	50	0336800000
Q 4 SAK4	41 A	50	0336900000
Q 10 SAK4	41 A	20	0368800000
VL 2 SAK4	32 A	50	0197000000
VH 19/5/3.5 SAK4-16		50	0285100000
BFSC M3X25		100	0292500000
Width			
PS 2.3 RT	5.4 mm	20	0180400000
STB 14/D5/2.3/M3 SAK2.5		50	0168600000
AP SAK4-10 KRG	1.5 mm	20	0117920000
AP SAK4-10 KRG/BL	1.5 mm	20	0117970000
TW SAK4-10 KRG	2.5 mm	20	0130120000
TW SAK4-10 KRG/BL	2.5 mm	20	0130170000
TSCH 1	2 mm	100	0319160000
AD 4 SAK4		50	0285300000
BFSC M3X22 PA/RT		100	0128900000

DEK 5/6,5 / SCHT 7

Feed-through modular terminals

TS 35 / KrG

In hazardous area applications, the installation instructions and the rated data specifications for accessories given in the technical appendix must be followed.

Width/Length/height with TS35x7.5	mm
max. current / max. cond. cross-section	A/mm ²
Max. clamping range	mm ²

Technical data

Rated data	
Rated voltage	V
Rated current	A
Rated cross-section	mm ²
Rated impulse voltage / Pollution severity	kV/-
Gauge to IEC 60947-1 / UL94 Flammability class	
Approvals	
Clamped conductors (H05V/H07V)	
solid / stranded	mm ²
flexible / Stranded wire with end ferrules	mm ²
Tightening torque range (clamping screw)	
Stripping length / Blade size	mm/-
Note	

Ordering data

Version	
	Medium yellow
	Blue
Note	

Accessories

Screwable cross-connection	
	2-pole
	3-pole
	4-pole
	10-pole
	Connecting sleeve
	Mounting screw
	Lock washer
Switchable link	
	Switchable link
	Connecting sleeve
	Mounting screw
Testing / Checking	
	Test plug
	Socket
End plate / Partition plate	
	Medium yellow
	Blue
	Medium yellow
	Blue
Small partition	
	Small partition
Cover / warning label	
	Cover / warning label
	Mounting screw (plastic)
Marking systems	(see assortment in catalogue 7)
	Marking tags
For detailed information on other accessories and applications, refer to the „Accessories“ section	

SAK 6

6 mm²

8 x 45 x 44
57 / 10
0.33...10

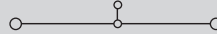

IEC 60947-7-1	Ex e ll			Ex ll	II 2 G D
IEC	UL	CSA	EN 60079-7		
800	600	600	550		
41	40	47	36		
6	AWG 22...8	AWG 20...8	6		
8 / 3					
A5 / 5VA					
KEMA 97ATEX1798 U					
Rated connection					
0.5...10 / 0.5...6					
0.5...10 / 0.5...6					
0.8...1.6 Nm (M 3.5)					
12 / 4.0 x 0.8 mm					
For AWG 8-7 and AWG 8-19, tightening torque is 1.21.4 Nm					

Type	Qty.	Order No.
SAK 6/35 KRG	100	0380520000
SAK 6/35 KRG/BL	100	0380570000
With AWG 6 and H07V-R10 conductors, an increased MD torque of 1.4 to 1.6 Nm should be used.		

Type	current	Qty.	Order No.
Q 2 SAK6N	57 A	50	0456700000
Q 3 SAK6N	57 A	50	0456800000
Q 4 SAK6N	57 A	50	0456900000
Q 10 SAK6N	57 A	20	0457000000
Width			
PS 4 F.STB 4	7.6 mm	20	0299600000
STB 14/D6/4/M3 SAK10		50	0169900000
Width			
VL 2 SAK6N/SAKT		50	0194700000
VH 19/5/3.5 SAK4-16		50	0285100000
BFSC M3X25		100	0292500000
Width			
AP SAK4-10 KRG	1.5 mm	20	0117920000
AP SAK4-10 KRG/BL	1.5 mm	20	0117970000
TW SAK4-10 KRG	2.5 mm	20	0130120000
TW SAK4-10 KRG/BL	2.5 mm	20	0130170000
Width			
TSCH 1	2 mm	100	0319160000
Width			
AD 4 SAK6N		50	0196600000
BFSC M3X22 PA/RT		100	0128900000

DEK 5/8 / SCHAT 7
 When used with twin ferrules ZH 0.5 - ZH 4, the rated voltage is 690 V.

SAK 10

10 mm²

10 x 45 x 51.5
76 / 16
1.5...16

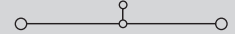

IEC 60947-7-1	Ex e ll			Ex ll	II 2 G D
IEC	UL	CSA	EN 60079-7		
800	600	600	550		
57	60	65	50		
10	AWG 14...6	AWG 16...6	10		
8 / 3					
B6 / 5VA					
KEMA 97ATEX1798 U					
Rated connection					
1.5...10 / 1.5...16					
1.5...16 / 1.5...10					
2.0...4.0 Nm (M 4)					
12 / 1.0 x 5.5 mm					
When used with twin ferrules ZH 0.5 - ZH 4, the rated voltage is 690 V.					

Type	Qty.	Order No.
SAK 10/35 KRG	100	0443720000
SAK 10/35 KRG/BL	100	0443770000
A higher torque of 2 to 2.4 Nm is necessary when using H07V-R16 and AWG 6 conductors.		

Type	current	Qty.	Order No.
Q 2 SAK10	57 A	50	0457100000
Q 3 SAK10	57 A	50	0457200000
Q 4 SAK10	57 A	50	0457300000
Q 10 SAK10	57 A	20	0457400000
Width			
PS 4 F.STB 4	7.6 mm	20	0299600000
STB 14/D6/4/M3 SAK10		50	0169900000
Width			
VL 2 SAK6/10/SAKB	32 A	50	0135900000
VH 19/5/3.5 SAK4-16		50	0285100000
BFSC M3X25		100	0292500000
Width			
AP SAK4-10 KRG	1.5 mm	20	0117920000
AP SAK4-10 KRG/BL	1.5 mm	20	0117970000
TW SAK4-10 KRG	2.5 mm	20	0130120000
TW SAK4-10 KRG/BL	2.5 mm	20	0130170000
Width			
TSCH 1	2 mm	100	0319160000
Width			
AD 4 SAK10		50	0178600000
BFSC M3X22 PA/RT		100	0128900000

DEK 5/5

SAK 16

16 mm²



12 x 50 x 57.5
76 / 16
2.5...16

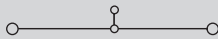

IEC 60947-7-1

Ex e II II 2 G D

IEC	UL	CSA	EN 60079-7
1000	600	600	690
76	80	87	66
16	AWG 12...4	AWG 14...6	16
8 / 3			
B6 / 5VA			

KEMA 97ATEX1798 U

Rated connection

2.5...16 / 4...16
 4...16 / 4...16
 2.0...4.0 Nm (M 4)
 15 / 1.0 x 5.5 mm

Twin wire end ferrules ZH 2.5 - ZH 16 can be used.

Type	Qty.	Order No.
SAK 16/35 KRG	50	0380620000

If QIs are aligned side by side, then a TW/AP must be used.

Type	current	Qty.	Order No.
Q 2 SAK16	76 A	50	0457500000
Q 3 SAK16	76 A	50	0457600000
Q 4 SAK16	76 A	50	0457700000
Q 10 SAK16	76 A	20	0457800000
Width			
VL 2 SAK16/SAKA	57 A	50	0135800000
VH 19/5/3.5 SAK4-16		50	0285100000
BFSC M3X25		100	0292500000
Width			
PS 4 F.STB 4	7.6 mm	20	0299600000
STB 14/D6/4/M3 SAK10		50	0169900000
AP SAK16 KRG	3 mm	20	0271120000
TW SAK16 KRG	3 mm	20	0281120000
Width			
TSCH 1	2 mm	100	0319160000
AD 4 SAK16		50	0518200000
BFSC M3X22 PA/RT		100	0128900000

DEK 5/5

SAK 35N/35

35 mm²



16 x 58 x 60
125 / 50
2.5...50

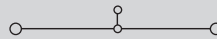

IEC 60947-7-1

IEC	UL	CSA
1000	600	600
125	105	120
35	AWG 12...2	AWG 12...2
8 / 3		
B8 / 5VA		

Rated connection

2.5...16 / 4...50
 2.5...35 / 1.5...35
 4.0...5.0 Nm (M 6)
 18 / 6.5 x 1.2 mm

The tightening torque is 4.5 Nm for 16 - 50 mm² and AWG 6 - 2/7 stranded conductors. Twin wire end ferrules ZH 2.5 - ZH 16 can be used.

Type	Qty.	Order No.
SAK 35N/35 KRG	20	0608220000

It is possible to use twin ferrules with identical rated voltages (LAB 13090).

Type	current	Qty.	Order No.
QL 2 SAK35N	110 A	50	0564900000
QL 3 SAK35N	110 A	50	0565000000
QL 4 SAK35N	110 A	50	0565100000
QL 10 SAK35N	110 A	20	0565200000
VH 17/8/5 SAK35		50	0267000000
BFSC M4X30		50	0267100000
SS M4 D 128-A 4		100	0136400000
Width			
PS 4 F.STB 4	7.6 mm	20	0299600000
STB 16/D7/4/M4 SAK35		50	0140200000
AP SAK35 KRG	3 mm	10	0303620000
AP SAK35 KRG/BL	3 mm	10	0303670000
TW SAK35 KRG	3 mm	20	0304320000
Width			
AD 4 SAK35		50	0178700000
BFSC M3X22 PA/RT		100	0128900000

DEK 5/5

If QIs are aligned side by side, then a TW/AP must be used.

SAK 35N/35/IK

35 mm²

Hexagon socket head screw

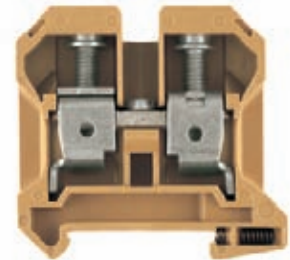

16 x 58 x 60
125 / 50
2.5...50

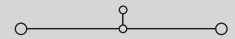

IEC 60947-7-1

IEC	UL	CSA
1000	600	600
125	105	120
35	AWG 12...2	AWG 12...2
8 / 3		
B8 / 5VA		

Rated connection

2.5...16 / 4...50
 2.5...35 / 1.5...35
 4.0...6.0 Nm (M 6)
 18 / S4 (DIN 6911)

The tightening torque is 4.5 Nm for 16 - 50 mm² and AWG 6 - 2/7 stranded conductors. Twin wire end ferrules ZH 2.5 - ZH 16 can be used.

Type	Qty.	Order No.
SAK 35N/35/IK KRG	20	0608320000
SAK 35N/35/IK KRG/BL	20	0608370000

It is possible to use twin ferrules with identical rated voltages (LAB 13090).

Type	current	Qty.	Order No.
QL 2 SAK35N	99 A	50	0564900000
QL 3 SAK35N	99 A	50	0565000000
QL 4 SAK35N	99 A	50	0565100000
QL 10 SAK35N	99 A	20	0565200000
VH 17/8/5 SAK35		50	0267000000
BFSC M4X30		50	0267100000
SS M4 D 128-A 4		100	0136400000
Width			
PS 4 F.STB 4	7.6 mm	20	0299600000
STB 16/D7/4/M4 SAK35		50	0140200000
AP SAK35 KRG	3 mm	10	0303620000
AP SAK35 KRG/BL	3 mm	10	0303670000
TW SAK35 KRG	3 mm	20	0304320000
Width			
AD 4 SAK35N		50	0576700000
BFSC M4X32 PA/RT		100	0129100000

DEK 5/5

If QIs are aligned side by side, then a TW/AP must be used.

Feed-through modular terminals

TS 35 / KrG

In hazardous area applications, the installation instructions and the rated data specifications for accessories given in the technical appendix must be followed.

Width/Length/height with TS35x7.5	mm
max. current / max. cond. cross-section	A/mm ²
Max. clamping range	mm ²

Technical data

Rated data

Rated voltage	V
Rated current	A
Rated cross-section	mm ²
Rated impulse voltage / Pollution severity	kV/-
Gauge to IEC 60947-1 / UL94 Flammability class	
Approvals	

Clamped conductors (H05V/H07V)

solid / stranded	mm ²
flexible / Stranded wire with end ferrules	mm ²
Tightening torque range (clamping screw)	
Stripping length / Blade size	mm/-

Note

Ordering data

Version

Medium yellow
Blue

Note

Accessories

Screwable cross-connection



2-pole
3-pole
4-pole
10-pole
Connecting sleeve
Mounting screw
Lock washer

Switchable link

Switchable link
Connecting sleeve
Mounting screw

Testing / Checking

Test plug
Socket

End plate / Partition plate

Medium yellow
Blue
Medium yellow
Blue

Small partition

Small partition

Cover / warning label

Cover / warning label
Mounting screw (plastic)

Marking systems (see assortment in catalogue 7)

Marking tags

For detailed information on other accessories and applications, refer to the „Accessories“ section

SAK 95/35

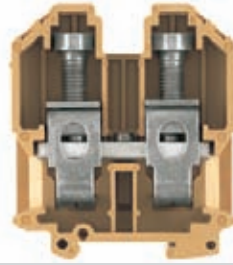
95 mm²

28 x 87.9 x 96.5

269 / 120

16...120

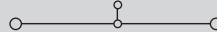

IEC 60947-7-1

IEC	UL	CSA
1000	600	600
232	190	200
95	AWG 6...4/0	AWG 6...4/0
8 / 3		
B12 / 5VA		



Rated connection

16...16 / 10...120
16...95 / 10...95
16...20 Nm (M 10)
30 / S8 (DIN 6911)

Ribbon cable (segmented ribbon) can be connected ranging from 3 to 6 segments of 0.8x9 mm, up to 6 segments of 0.8x16 mm and up to 6 segments of 0.5x13 mm.

Type	Qty.	Order No.
SAK 95/35 KRG	10	0662220000

Type	current	Qty.	Order No.
QL 2 SAKG28	125 A	10	0551200000
QL 3 SAKG28	232 A	5	0407600000
QL 4 SAKG28	125 A	5	0407700000
VH 35/11/5.5 SAK95		10	0551100000
KISC M5X50/26 SAK95		20	0630200000
SS M5 D 128-A 5		50	0346100000

	Width	Qty.	Order No.
PS 4 F.STB 4	7.6 mm	20	0299600000
STB 16/D7/4/M5 SAK70		50	0385400000

AP SAK95 KRG	3 mm	10	0550920000
AP SAK95 KRG/BL	3 mm	10	0550970000

ADP 3/HP3 1M	20	0485400000
BFSC M5X45 PA/NA	50	0344400000

DEK 5/5 / SCHT 7

Holder HP 3 0485760000 for the ADP 3-Profil.

TS 35 / PA

RSF 3/35

4 mm²



In hazardous area applications, the installation instructions and the rated data specifications for accessories given in the technical appendix must be followed.

Width/Length/height with TS35x7.5	mm
max. current / max. cond. cross-section	A/mm ²
Max. clamping range	mm ²

8 x 50 x 60
32 / 4
0.33...4

Technical data

Rated data	
Rated voltage	V
Rated current	A
Rated cross-section	mm ²
Rated impulse voltage / Pollution severity	kV/-
Gauge to IEC 60947-1 / UL94 Flammability class	
Approvals	
Clamped conductors (H05V/H07V)	
solid / stranded	mm ²
flexible / Stranded wire with end ferrules	mm ²
Tightening torque range (clamping screw)	
Stripping length / Blade size	mm/-

IEC 60947-7-1

IEC	UL	CSA
690	600	600
32	20	25
4	AWG 22...12	AWG 22...12
	6 / 3	
	/ V2	

Rated connection	
0.5...4 / 0.5...4	
0.5...4 / 0.5...4	
0.5...1.0 Nm (M 3)	
12 / 0.6 x 3.5 mm	

Note

Ordering data

Version
beige

Note

Type	Qty.	Order No.
RSF 3/35	50	9501160000

Accessories

Screwable cross-connection	
2-pole	
3-pole	
4-pole	
10-pole	
Connecting sleeve	
Mounting screw	
Lock washer	



Switchable link	
Switchable link	
Connecting sleeve	
Mounting screw	

Testing / Checking	
Test plug	
Socket	

End plate / Partition plate	
beige	
beige	

Small partition	
Small partition	

Cover / warning label	
Cover / warning label	

Type	current	Qty.	Order No.
QL 2 SAK6N	57 A	50	0194300000
QL 3 SAK6N	57 A	50	0194400000
QL 4 SAK6N	57 A	50	0194500000
QL 10 SAK6N	57 A	20	0338300000
VH 13.5/4.9/3.3 SAK4		100	0248500000
KISC M3X20.5/10 EK4		100	0303000000
SS M3 D 128-A 3		50	0164400000
Width			
PS 2.3 RT	5.4 mm	20	0180400000
STB 14/D5/2.3/M3 SAK2.5		50	0168600000
AP RSF3	3 mm	10	0270460000
TW AST1/PA HP/DBR/0.5	0.5 mm	20	0474700000
TSCH 1	2 mm	100	0319160000
ADP 2/HP2 1M		36	0485300000

Marking systems	
(see assortment in catalogue 7)	
Marking tags	

DEK 5/5

For detailed information on other accessories and applications, refer to the „Accessories“ section

Two-tier modular terminals

TS 35 / PA

Width/Length/height with TS35x7.5	mm
max. current / max. cond. cross-section	A/mm ²
Max. clamping range	mm ²

Technical data

Rated data	
Rated voltage	V
Rated current	A
Rated cross-section	mm ²
Rated impulse voltage / Pollution severity	kV/-
Gauge to IEC 60947-1 / UL94 Flammability class	
Approvals	

Clamped conductors (H05V/H07V)

solid / stranded	mm ²
flexible / Stranded wire with end ferrules	mm ²
Tightening torque range (clamping screw)	
Stripping length / Blade size	mm/-

2 conductors with same cross-section (H05V/H07V)

solid / stranded	mm ²
flexible / Stranded wire with end ferrules	mm ²

Note

Ordering data

Version	
	beige
	Blue

Note

Accessories

Screwable cross-connection



2-pole	
3-pole	
4-pole	
10-pole	

Testing / Checking

Test plug	
Socket	

End plate / Partition plate

beige	
Blue	
Dark beige Wemid	

Small partition

Small partition	
-----------------	--

Cover / warning label

Cover / warning label	
Mounting screw (plastic)	

Marking systems (see assortment in catalogue 7)

Marking tags	
--------------	--

For detailed information on other accessories and applications, refer to the „Accessories“ section

DK 4/35

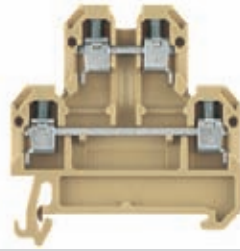
4 mm²

6 x 50 x 60.5

41 / 6

0.13...6

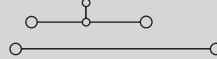

IEC 60947-7-1

IEC	UL	CSA
500	300	300
32	27	10
4	AWG 22...12	AWG 26...12
6 / 3		
A3 / V2		



Rated connection

0.5...6 / 0.5...4
0.5...4 / 0.5...2.5
0.5...0.8 Nm (M 3)
8 / 0.6 x 3.5 mm

0.5...1.5

0.5...1.5 / 0.5...1.5

With twin ferrules ZH 0.5 to ZH 2.5, rated voltage is 690 V.

Type	Qty.	Order No.
DK 4/35	100	0527660000
DK 4/35 BL	100	0527680000

Type	current	Qty.	Order No.
Q 2 AKZ4	32 A	50	0336400000
Q 3 AKZ4	32 A	50	0336500000
Q 4 AKZ4	32 A	50	0336600000
Q 10 AKZ4	32 A	20	0368600000

Width

PS 2.3 RT	5.4 mm	20	0180400000
STB 8.5/D4/2.3/M2.5 AKZ		50	0215700000

AP DK4	1.5 mm	20	0359260000
AP DK4 BL	1.5 mm	20	0359280000

WTW EN	3 mm	20	1058800000
--------	------	----	------------

TSCH 6 DK1 S4	5 mm	100	0190260000
---------------	------	-----	------------

AD 3 SAK2.5	50	0297900000
BFSC M2.5X18 PA/RT	100	0303300000

DEK 5/6

DK 4 Q/35

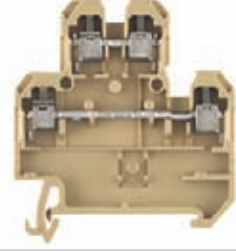
4 mm²

6 x 50 x 60.5

41 / 6

0.13...6

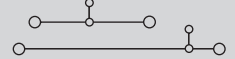

IEC 60947-7-1

IEC	UL	CSA
500	300	300
32	27	10
4	AWG 22...12	AWG 26...12
6 / 3		
A3 / V2		



Rated connection

0.5...6 / 0.5...4
0.5...4 / 0.5...2.5
0.5...0.8 Nm (M 3)
8 / 0.6 x 3.5 mm

0.5...1.5

0.5...1.5 / 0.5...1.5

With twin ferrules ZH 0.5 to ZH 2.5, rated voltage is 690 V.

Type	Qty.	Order No.
DK 4Q/35	100	0590160000
DK 4Q/35 BL	100	0590180000

Type	current	Qty.	Order No.
Q 2 AKZ4	32 A	50	0336400000
Q 3 AKZ4	32 A	50	0336500000
Q 4 AKZ4	32 A	50	0336600000
Q 10 AKZ4	32 A	20	0368600000

Width

PS 2.3 RT	5.4 mm	20	0180400000
STB 8.5/D4/2.3/M2.5 AKZ		50	0215700000

AP DK4Q	1.5 mm	20	1397160000
AP DK4Q BL	1.5 mm	20	1397180000

WTW EN	3 mm	20	1058800000
--------	------	----	------------

TSCH 6 DK1 S4	5 mm	100	0190260000
---------------	------	-----	------------

AD 3 SAK2.5	50	0297900000
BFSC M2.5X18 PA/RT	100	0303300000

DEK 5/6

DK 4 QV/35

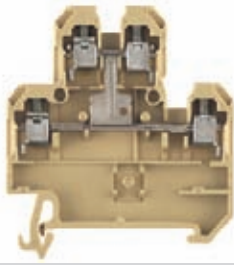
4 mm²

6 x 54 x 40.5

41 / 6

0.13...6

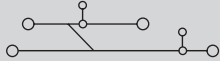

IEC 60947-7-1

IEC	UL	CSA
500	300	300
32	27	10
4	AWG 22...12	AWG 26...12
	6 / 3	
	A3 / V2	

Rated connection

0.5...6 / 0.5...4

0.5...4 / 0.5...2.5

0.5...0.8 Nm (M 3)

8 / 0.6 x 3.5 mm

0.5...1.5

0.5...1.5 / 0.5...1.5

With twin ferrules ZH 0.5 to ZH 2.5, rated voltage is 690 V.

Type	Qty.	Order No.
DK 4QV/35	100	0363660000
DK 4QV/35 BL	100	0363680000

Type	current	Qty.	Order No.
Q 2 AKZ4	32 A	50	0336400000
Q 3 AKZ4	32 A	50	0336500000
Q 4 AKZ4	32 A	50	0336600000
Q 10 AKZ4	32 A	20	0368600000
Width			
PS 2.3 RT	5.4 mm	20	0180400000
STB 8.5/D4/2.3/M2.5 AKZ		50	0215700000
AP DK4Q	1.5 mm	20	1397160000
AP DK4Q BL	1.5 mm	20	1397180000
WTW EN	3 mm	20	1058800000
TSCH 6 DKI S4	5 mm	100	0190260000
AD 4 AKZ4		50	0303400000
BFSC M2.5X18 PA/RT		100	0303300000

DEK 5/6

Modular PE terminals

TS 35 / PA

Width/Length/height with TS35x7.5 mm
 max. current / max. cond. cross-section A/mm²
 Max. clamping range mm²

Technical data

Rated data	
Rated cross-section	mm ²
Rated voltage to adjacent terminal	V
Rated impulse withstand voltage to adjacent terminal	kV
Short-time withstand current	
Pollution severity	
Gauge to IEC 60947-1 / UL94 Flammability class	
Approvals	
Clamped conductors (H05V/H07V)	
solid / stranded	mm ²
flexible / Stranded wire with end ferrules	mm ²
Tightening torque range (clamping screw)	
Tightening torque range (fixing screw)	
Stripping length / Blade size	mm/-

Note

Ordering data

Version
green/yellow
Note

Accessories

Rail support

Marking systems (see assortment in catalogue 7)
 Marking tags

For detailed information on other accessories and applications, refer to the „Accessories“ section

EK 2.5/35

2.5 mm²

6 x 56.5 x 40
 / 6
 0.33...6

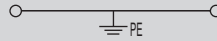

IEC 60947-7-2

IEC	UL	CSA
2.5	AWG 22...12	AWG 26...10
800		
8		
	480 A (4 mm ²)	
	3	
	A3 / V2	



Rated connection

0.5...6 / 0.5...4
0.5...4 / 0.5...2.5
0.4...0.6 Nm (M 2.5)
0.4...0.6 Nm
10 / 0.6 x 3.5 mm

Type	Qty.	Order No.
EK 2.5/35	100	0661060000

Type	Width	Qty.	Order No.
SH 2	40 mm	10	0494920000

DEK 5/6

EK 4/35

4 mm²

6.5 x 56.5 x 44
 / 6
 0.33...6

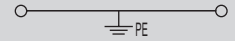

IEC 60947-7-2

IEC	UL	CSA
4	AWG 22...12	AWG 26...10
800		
8		
	720 A (6 mm ²)	
	3	
	A4 / V2	



Rated connection

0.5...6 / 0.5...4
0.5...4 / 0.5...4
0.5...1.0 Nm (M 3)
0.5...1.0 Nm
12 / 0.6 x 3.5 mm

Type	Qty.	Order No.
EK 4/35	100	0661160000

Type	Width	Qty.	Order No.
SH 2	40 mm	10	0494920000

DEK 5/6,5

EK 6/35

6 mm²



8 x 56.5 x 44
/ 10
0.5...10

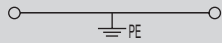

IEC 60947-7-2

IEC	UL	CSA
6	AWG 22...8	AWG 20...8
800		
8		
	720 A (6 mm ²)	
	3	
	A5 / V2	



Rated connection

0.5...10 / 1.5...6
0.5...10 / 0.5...6
0.8...1.6 Nm (M 3.5)
0.5...1.0 Nm
12 / 4.0 x 0.8 mm

For AWG 8-7 and AWG 8-19, tightening torque is 1.21.4 Nm

Type	Qty.	Order No.
EK 6/35	100	0661260000

Type	Width	Qty.	Order No.
SH 2	40 mm	10	0494920000

EK 10

10 mm²



10 x 56 x 45
/ 10
0.5...10

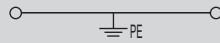

IEC 60947-7-2

IEC	UL	CSA
10	AWG 14...6	AWG 14...6
800		
8		
	1200 A (10 mm ²)	
	3	
	B6 / V2	



Rated connection

0.5...10 / 1.5...6
0.5...10 / 0.5...10
1.2...2.4 Nm (M 4)
0.5...1.0 Nm
12 / 1.0 x 5.5 mm

Type	Qty.	Order No.
EK 10/35	100	0661360000

Type	Width	Qty.	Order No.
SH 2	40 mm	10	0494920000

EK 16

16 mm²



12 x 56 x 50
/ 16
2.5...16

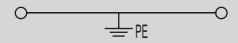

IEC 60947-7-2

IEC	UL	CSA
16	AWG 10...6	AWG 10...4
800		
8		
	1920 A (16 mm ²)	
	3	
	B6 / V2	



Rated connection

2.5...16 / 2.5...16
2.5...16 / 4...16
2.0...4.0 Nm (M 4)
0.5...1.0 Nm
16 / 1.0 x 5.5 mm

Type	Qty.	Order No.
EK 16/35	50	0190160000

Type	Width	Qty.	Order No.
SH 2	40 mm	10	0494920000

DEK 5/8

DEK 5/5

DEK 5/5

Modular PE terminals

TS 35 / PA

In hazardous area applications, the installation instructions and the rated data specifications for accessories given in the technical appendix must be followed.

Width/Length/height with TS35x7.5 mm
 max. current / max. cond. cross-section A/mm²
 Max. clamping range mm²

Technical data

Rated data	
Rated cross-section	mm ²
Rated voltage to adjacent terminal	V
Rated impulse withstand voltage to adjacent terminal	kV
Short-time withstand current	
Pollution severity	
Gauge to IEC 60947-1 / UL94 Flammability class	
Approvals	
Clamped conductors (H05V/H07V)	
solid / stranded	mm ²
flexible / Stranded wire with end ferrules	mm ²
Tightening torque range (clamping screw)	
Tightening torque range (fixing screw)	
Stripping length / Blade size	mm/-

Note

Ordering data

Version
green/yellow
Note

Accessories

Rail support

Marking systems (see assortment in catalogue 7)
 Marking tags

For detailed information on other accessories and applications, refer to the „Accessories“ section

EK 35/35

35 mm²

16 x 58 x 60
 / 50
 6...50

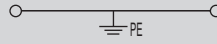

IEC 60947-7-2

IEC	UL	CSA
35	AWG 6...2	AWG 12...2
800		
8		
	4200 A (35 mm ²)	
	3	
	B9 / V2	



Rated connection

6...16 / 16...50
10...35 / 10...35
4.0...6.0 Nm (M 6)
1.2...2.4 Nm
20 / 6.5 x 1.2 mm

Use the TS 35x15/2.3 for 35 - 50 mm² conductors. For AWG 2/7 and H07V-R50, torque is 6 Nm.

Type	Qty.	Order No.
EK 35/35	20	0661460000

Type	Width	Qty.	Order No.
SH 2	40 mm	10	0494920000

DEK 5/5

EK 95/35

95 mm²

25 x 76.5 x 90.5
 / 120
 10...120

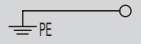

IEC 60947-7-2

IEC	UL	CSA
95		
8		
	11400 A (95 mm ²)	
	3	
	B12 / ---	

Rated connection

10...16 / 10...95
16...95 / 10...95
10...20 Nm (M 10)
1.2...2.4 Nm
27 /

Tightening torque for stranded conductors of 35 mm² and larger = 16 Nm

Type	Qty.	Order No.
EK 95/35/1ZB BK	10	0535300000

Type	Width	Qty.	Order No.
SH 2	40 mm	10	0494920000

To fix the terminals use the copper rail TS35 order no. 0270100000.

SAKE 70/35

70 mm²



18 x 94 x 59.5
 / 70
 10...70

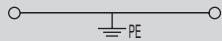

IEC 60947-7-2

IEC	UL	CSA
70		
B10 / ---		

Rated connection

10...16 / 10...70
10...70 / 10...70
6.0...12 Nm (M 8)
2.0...4.0 Nm
25 /

When connecting with stranded conductors ≥ 50 mm² and 12 Nm tightening torque. Test current 8,4 kA to IK carried out via copper terminal rail

Type	Qty.	Order No.
EK 70/35/M.2ZB O.IK	10	1338300000

Type	Width	Qty.	Order No.
SH 2	40 mm	10	0494920000

Use the steel TS 35x15/2.3 for 35 - 50 mm² conductors. Use the TS 35x15/2.3 CU for 70 mm² conductors.

Disconnect terminals

TS 35 / PA

In hazardous area applications, the installation instructions and the rated data specifications for accessories given in the technical appendix must be followed.

Width/Length/height with TS35x7.5	mm
max. current / max. cond. cross-section	A/mm ²
Max. clamping range	mm ²

Technical data

Rated data	
Rated voltage	V
Rated current	A
Rated cross-section	mm ²
Rated impulse voltage / Pollution severity	kV/-
Gauge to IEC 60947-1 / UL94 Flammability class	
Approvals	
Clamped conductors (H05V/H07V)	
solid / stranded	mm ²
flexible / Stranded wire with end ferrules	mm ²
Tightening torque range (clamping screw)	
Stripping length / Blade size	mm/-
Note	

Ordering data

Version	
	beige
	Blue
Note	

Accessories

External cross-connection	
	2-pole
	3-pole
	4-pole
Testing / Checking	
	Test plug
	Socket
End plate / Partition plate	
	beige
	Blue

Marking systems	
	(see assortment in catalogue 7)
For detailed information on other accessories and applications, refer to the „Accessories“ section	

SAKR

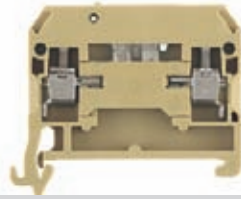
4 mm²

6.5 x 42 x 40.5	
10 / 4	
0.13...4	

IEC 60947-7-1

IEC	UL	CSA
400	300	300
10	10	10
4	AWG 22...12	AWG 22...12
	6 / 3	
	A3 / V2	



Rated connection

0.5...4 / 1.5...4
0.5...4 / 0.5...2.5
0.5...1.0 Nm (M 3)
8 / 0.6 x 3.5 mm

Torque for SAKR with socket: 0.5 - 0.7 Nm.

Type	Qty.	Order No.
SAKR/35	100	0172160000
SAKR/35 BL	100	0172180000
SAKR/35 2 StB order no. 0183360000		

Type	current	Qty.	Order No.
QB 2 WI RA6 IS	27 A	50	0482700000
QB 3 WI RA6 IS	27 A	50	0482800000
QB 4 WI RA6 IS	27 A	50	0482900000
Width			
PS 2,3 RT	5.4 mm	20	0180400000
STB 6/D3.7/2.3/M3 SAKR		100	0379400000
Width			
AP SAKR BE	1.5 mm	20	0211360000
AP SAKR BL	1.5 mm	20	0211380000

DEK 5/6,5

QB 25 blank, refer to „Accessories“ section. Note that max. conductor connection with QB = 2.5 mm². Twin wire-end ferrules ZH 0.5 - ZH 1.5

SAKR-D

4 mm²

6.5 x 46 x 38	
10 / 4	
0.13...4	

IEC 60947-7-1

IEC	UL	CSA
250	300	300
10	10	10
4	AWG 26...12	AWG 22...12
	6 / 3	
	A3 / V2	



Rated connection

0.5...4 / 1.5...4
0.5...4 / 0.5...2.5
0.5...1.0 Nm (M 3)
8 / 0.6 x 3.5 mm

Tightening torque via the sockets is 0.5 - 0.7 Nm.

Type	Qty.	Order No.
SAKRD/35	50	0185760000

Type	current	Qty.	Order No.
QB 2 WI RA6 IS	27 A	50	0482700000
QB 3 WI RA6 IS	27 A	50	0482800000
QB 4 WI RA6 IS	27 A	50	0482900000
Width			
PS 2,3 RT	5.4 mm	20	0180400000
STB 6/D3.7/2.3/M3 SAKR		100	0379400000
Width			
AP SAKR BE	1.5 mm	20	0211360000
AP SAKR BL	1.5 mm	20	0211380000

DEK 5/6,5

Twin wire-end ferrules ZH 0.5 - ZH 1.5 can be used.

DKT 4

4 mm²

Without separated busbar



6 x 65 x 56.5
10 / 4
0.13...4

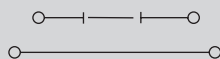

IEC 60947-7-1

IEC	UL	CSA
400		
10		
4		
	6 / 3	
	A3 / V2	



Rated connection

0.2...4 / 1.5...4
0.2...4 / 0.5...2.5
0.5...1.0 Nm (M 3)
9 / 0.6 x 3.5 mm

Type	Qty.	Order No.
DKT 4/35	100	0687460000
DKT 4/35 2 StB Order No. 0327960000		

Type	current	Qty.	Order No.
QB 2 WI RA6 IS	27 A	50	0482700000
QB 3 WI RA6 IS	27 A	50	0482800000
QB 4 WI RA6 IS	27 A	50	0482900000
Width			
PS 2.3 RT	5.4 mm	20	0180400000
AP DKT4 PA	1.5 mm	20	0687560000

DEK 5/6

DKT 4 V

4 mm²

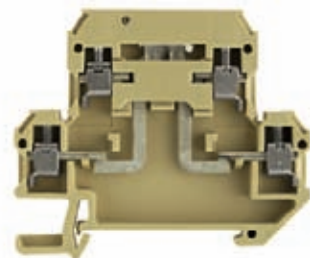

6 x 65 x 56.5
10 / 4
0.13...4

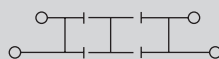

IEC 60947-7-1

IEC	UL	CSA
400		
10		
4		
	6 / 3	
	A3 / V2	



Rated connection

0.5...4 / 1.5...4
0.5...4 / 0.5...2.5
0.5...1.0 Nm (M 3)
9 / 0.6 x 3.5 mm

Type	Qty.	Order No.
DKT 4V/35 2STB	100	1304960000

Type	current	Qty.	Order No.
QB 2 WI RA6 IS	27 A	50	0482700000
QB 3 WI RA6 IS	27 A	50	0482800000
QB 4 WI RA6 IS	27 A	50	0482900000
Width			
PS 2.3 RT	5.4 mm	20	0180400000
AP DKT4 PA	1.5 mm	20	0687560000

DEK 5/6

Disconnect terminals

TS 35 / KrG

In hazardous area applications, the installation instructions and the rated data specifications for accessories given in the technical appendix must be followed.

Width/Length/height with TS35x7.5	mm
max. current / max. cond. cross-section	A/mm ²
Max. clamping range	mm ²

Technical data

Rated data	
Rated voltage	V
Rated current	A
Rated cross-section	mm ²
Rated impulse voltage / Pollution severity	kV/-
Gauge to IEC 60947-1 / UL94 Flammability class	
Approvals	
Clamped conductors (H05V/H07V)	
solid / stranded	mm ²
flexible / Stranded wire with end ferrules	mm ²
Tightening torque range (clamping screw)	
Stripping length / Blade size	mm/-
Note	

Ordering data

Version	Medium yellow
Note	

Accessories

Screwable cross-connection	
	2-pole
	3-pole
	4-pole
	Connecting sleeve
	Mounting screw
	Lock washer
External cross-connection	
	2-pole
	3-pole
	4-pole
Testing / Checking	
	Test plug
	Socket
End plate / Partition plate	
	Medium yellow
	Blue
	beige
	Medium yellow
	Blue

Marking systems	(see assortment in catalogue 7)
	Marking tags
For detailed information on other accessories and applications, refer to the „Accessories“ section	

SAKC 4/35

4 mm²

6.5 x 49.5 x 59.5	
25 / 6	
0.33...6	

IEC 60947-7-1

IEC	UL	CSA
400	300	300
25	25	25
4	AWG 22...12	AWG 22...10
	6 / 3	
	A4 / 5VA	



Rated connection

0.5...6 / 1.5...4
0.5...4 / 0.5...4
0.5...1.0 Nm (M 3)
12 / 0.6 x 3.5 mm

UNDEFINED TEXT

Type	Qty.	Order No.
SAKC 4/35	100	0357520000
SAKC 4/35 2 StB order no. 0340620000. Tightening torque via the sockets is 0.5 - 0.7 Nm.		

Type	current	Qty.	Order No.
QB 2 WI RA6 IS	27 A	50	0482700000
QB 3 WI RA6 IS	27 A	50	0482800000
QB 4 WI RA6 IS	27 A	50	0482900000
Width			
PS 2.3 RT	5.4 mm	20	0180400000
Width			
AP SAK4-10 KRG	1.5 mm	20	0117920000
AP SAK4-10 KRG/BL	1.5 mm	20	0117970000
TW SAK4-10 KRG	2.5 mm	20	0130120000
TW SAK4-10 KRG/BL	2.5 mm	20	0130170000

DEK 5/6,5
Dummy plug and pull out tool see chapter accessories

SAKC 10/35

10 mm²

12 x 65 x 48.5	
27 / 10	
0.5...10	

IEC 60947-7-1

IEC	UL	CSA
500	300	600
27	25	25
10	AWG 22...8	AWG 20...10
	6 / 3	
	B6 / 5VA	



Rated connection

0.5...10 / 1.5...10
0.5...10 / 0.5...10
1.2...2.4 Nm (M 4)
12 / 1.0 x 5.5 mm

Connections for stranded conductors from 10 mm² require a tightening torque of 2 Nm.

Type	Qty.	Order No.
SAKC 10/35 1STB4 KRG	50	1404520000
SAKC 10/35 2 StB4 Order No. 1404620000 Tightening torque via the sockets is 1.2 Nm.		

Type	current	Qty.	Order No.
QL 2 SAKA10	47 A	50	0135500000
QL 3 SAKA10	47 A	50	0135600000
QL 4 SAKA10	47 A	50	0135700000
VH 13.6/7/4.2 SAKA10		50	0299700000
BFSC M4X20		100	0362800000
SS M4 D 128-A 4		100	0136400000
Width			
PS 4 F.STB 4	7.6 mm	20	0299600000
STB 17/D6/4/M4 SAKC10		50	0147100000
AP SAKB/C/T KRG	3 mm	20	0146720000
TW SAKB/C/T1	1.5 mm	20	0242960000
TW SAKB-C-T	3 mm	20	0242920000

DEK 5/6,5
Pull out force look under Accessories.

Fuse terminals

TS 35 / PA

Width/Length/height with TS35x7.5 mm
 max. current / max. cond. cross-section A/mm²
 Max. clamping range mm²

Technical data

Rated data	
Rated voltage	V
Rated current	A
Rated cross-section	mm ²
Rated impulse voltage / Pollution severity	kV/-
Gauge to IEC 60947-1 / UL94 Flammability class	
Approvals	

Clamped conductors (H05V/H07V)

solid / stranded	mm ²
flexible / Stranded wire with end ferrules	mm ²
Tightening torque range (clamping screw)	
Stripping length / Blade size	mm/-

2 conductors with same cross-section (H05V/H07V)

solid / stranded	-
flexible / Stranded wire with end ferrules	-

Note

Ordering data

Version

Note

Accessories

G-fuse cartridge, 5 x 20mm (IEC 60127-2)

0,10 A
0,20 A
0,25 A fast
0,50 A fast
0,63 A
1,00 A fast
1,60 A
2,00 A fast
2,50 A
3,15 A
4,00 A
5,00 A
6,30 A

G25 with indicator / imperial (inch) fuse

1,00 A
0,50 A medium slow / 2 A
1,00 A medium slow / 3 A

Contact sleeve

KSKM 1

10 mm²

5 x 20



13 x 69 x 63

6.3 / 16

0.13...16



IEC	UL	CSA
250	600	
6.3	10	
10	AWG 26...8	
B6 / V-0		



Rated connection

0.5...16
0.5...10
1.2...2.4 Nm (M 4)
12 / 1.0 x 5.5 mm

KSKM 2

10 mm²

1" x 1/4"

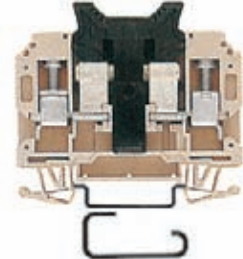

13 x 69 x 63

13 / 16

0.13...16



IEC	UL	CSA
250	600	
13	15	
10	AWG 26...8	
B6 / V-0		



Rated connection

0.5...16
0.5...10
1.2...2.4 Nm (M 4)
12 / 1.0 x 5.5 mm

Type	Qty.	Order No.
KSKM 1/35 G20	20	9509600000

Type	Qty.	Order No.
KSKM 2/35 GZ 1X1/4	20	9509610000

Type	Qty.	Order No.
G 20/0.10A/F	10	0430300000
G 20/0.20A/F	10	0430400000
G 20/0.25A/F	10	0430500000
G 20/0.50A/F	10	0430600000
G 20/0.63A/F	10	0439000000
G 20/1.00A/F	10	0430700000
G 20/1.60A/F	10	0430800000
G 20/2.00A/F	10	0430900000
G 20/2.50A/F	10	0431000000
G 20/3.15A/F	10	0431100000
G 20/4.00A/F	10	0431200000
G 20/5.00A/F	10	0431300000
G 20/6.30A/F	10	0431400000

Type	Width	Qty.	Order No.
SBL/1912		10	0446100000
SBL/2111		10	0446200000

Marking systems (see assortment in catalogue 7)

Marking tags

For detailed information on other accessories and applications, refer to the „Accessories“ section

DEK 5/5

DEK 5/5

Fuse 1" x 1/4" aren't available by Weidmüller.

Fuse terminals

TS 35 / KrG

In hazardous area applications, the installation instructions and the rated data specifications for accessories given in the technical appendix must be followed.

Width/Length/height with TS35x7.5	mm
max. current / max. cond. cross-section	A/mm ²
Max. clamping range	mm ²

Technical data

Rated data	
Rated voltage	V
Rated current	A
Rated cross-section	mm ²
Rated impulse voltage / Pollution severity	kV/-
Gauge to IEC 60947-1 / UL94 Flammability class	
Approvals	
Clamped conductors (H05V/H07V)	
solid / stranded	mm ²
flexible / Stranded wire with end ferrules	mm ²
Tightening torque range (clamping screw)	
Stripping length / Blade size	mm/-
Note	

Ordering data

Version	
	500 V AC/DC
	With GL 230 V AC/DC
	With GL 115 V AC/DC
	With LED 48 V AC
	With LED 24 V AC
	With LED +- 24 V DC
	500 V AC/DC
Note	

Accessories

Screwable cross-connection	
	2-pole
	3-pole
	4-pole
	10-pole
End plate / Partition plate	
	Medium yellow

Marking systems	(see assortment in catalogue 7)
	Marking tags
For detailed information on other accessories and applications, refer to the „Accessories“ section	

SAKS 1/35 5x20

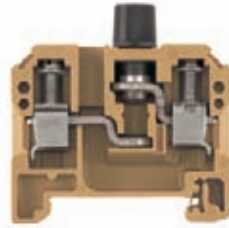
10 mm²

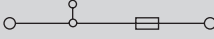
13 x 54 x 61	
10 / 16	
0.13...16	

IEC	UL	CSA
500	600	600
10	6.3	10
10	AWG 22...10	AWG 26...10
6 / 3		
B6 / 5VA		
		
Rated connection		
0.5...16 / 1.5...10		
0.5...10 / 0.5...10		
1.2...2.4 Nm (M 4)		
12 / 1.0 x 5.5 mm		
Connections for 10-mm ² stranded conductors require a tightening torque of 2 Nm.		

Type	Qty.	Order No.
SAKS 1/35/G20	20	0501620000

Type	current	Qty.	Order No.
QL 2 SAKS1	36 A	50	0191400000
QL 3 SAKS1	36 A	50	0191500000
QL 4 SAKS1	36 A	20	0191600000
QL 10 SAKS1	36 A	20	0338800000
Width			
AP SAKS1+3 KRG	3 mm	20	0191320000

Marking systems	(see assortment in catalogue 7)
	Marking tags
For detailed information on other accessories and applications, refer to the „Accessories“ section	

DEK 5/5

An M 3 x 6 mm screw, with order no. 0346200000, should be used for the cross-connection.

SAKS 1/35 5x20

10 mm²

With LED or glow lamp

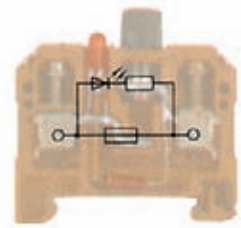

13 x 54 x 61	
6.3 / 16	
0.5...16	

IEC	UL	CSA
500		
6.3		
10	AWG 22...8	AWG 26...10
4 /		
B6 / 5VA		
		
Rated connection		
0.5...16 / 1.5...10		
0.5...10 / 0.5...10		
1.2...2.4 Nm (M 4)		
12 / 1.0 x 5.5 mm		
Connections for 10-mm ² stranded conductors require a tightening torque of 2 Nm.		

Type	Qty.	Order No.
SAKS 1/35 G20 GL 230VAC	10	0199920000
SAKS 1/35 G20 GL 115VAC	10	8068330000
SAKS 1/35 G20 LD 48VAC	10	0214020000
SAKS 1/35 G20 LD 24VAC	10	1111320000
SAKS 1/35 G20 LD 24VDC	10	0225820000

Type	Qty.	Order No.
Width		
AP SAKS1+3 KRG	3 mm	20 0191320000

Marking systems	(see assortment in catalogue 7)
	Marking tags
For detailed information on other accessories and applications, refer to the „Accessories“ section	

DEK 5/5

SAKS 1/35 5x25

10 mm²

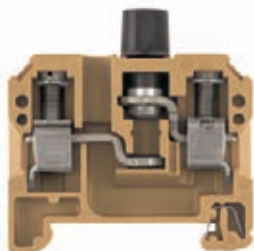

13 x 54 x 61
10 / 16
0.13...16

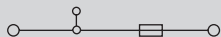

IEC	UL	CSA
500	300	600
10	6.3	10
10	AWG 22...8	AWG 26...10
6 / 3		
B6 / 5VA		

Rated connection

0.5...16 / 1.5...10
 0.5...10 / 0.5...10
 1.2...2.4 Nm (M 4)
 12 / 1.0 x 5.5 mm

Connections for 10-mm² stranded conductors require a tightening torque of 2 Nm.

Type	Qty.	Order No.
SAKS 1/35/G25	20	0501520000

Type	current	Qty.	Order No.
QL 2 SAKS1	36 A	50	0191400000
QL 3 SAKS1	36 A	50	0191500000
QL 4 SAKS1	36 A	20	0191600000
QL 10 SAKS1	36 A	20	0338800000
Width			
AP SAKS1+3 KRG	3 mm	20	0191320000

DEK 5/5
 An M 3 x 6 mm screw, with order no. 0346200000, should be used for the cross-connection.

SAKS 1/35 5x25

10 mm²

With glow lamp



13 x 54 x 61
6.3 / 16
0.5...16



IEC	UL	CSA
500		
6.3		
10	AWG 22...8	AWG 26...10
4 /		
B6 / 5VA		

Rated connection

0.5...16 / 1.5...10
 0.5...10 / 0.5...10
 1.2...2.4 Nm (M 4)
 12 / 1.0 x 5.5 mm

Connections for 10-mm² stranded conductors require a tightening torque of 2 Nm.

Type	Qty.	Order No.
SAKS 1/35 G25 GL 230VAC	10	0198620000

Type	Qty.	Order No.
Width		
AP SAKS1+3 KRG	3 mm	20 0191320000

DEK 5/5

SAKS 3/35

10 mm²

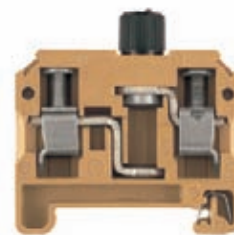

13 x 54 x 61
10 / 16
0.33...16

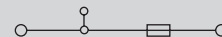

IEC	UL	CSA
500	300	600
10	10	10
10	AWG 22...8	AWG 22...10
6 / 3		
B6 / 5VA		

Rated connection

0.5...16 / 1.5...10
 0.5...10 / 0.5...10
 1.2...2.4 Nm (M 4)
 12 / 1.0 x 5.5 mm

Type	Qty.	Order No.
SAKS 3/35 G/5X30 500V	20	0328920000
SAKS 3/35 GZ/6.3X32	20	0667520000
SAKS 3 1"x1/4" with a red cap available under 0667420000.		

Type	Qty.	Order No.
Width		
AP SAKS1+3 KRG	3 mm	20 0191320000

DEK 5/5

Fuse terminals

TS 35 / KrG

Width/Length/height with TS35x7.5	mm
max. current / max. cond. cross-section	A/mm ²
Max. clamping range	mm ²

Technical data

Rated data	
Rated voltage	V
Rated current	A
Rated cross-section	mm ²
Rated impulse voltage / Pollution severity	kV/-
Gauge to IEC 60947-1 / UL94 Flammability class	
Approvals	
Clamped conductors (H05V/H07V)	
solid / stranded	mm ²
flexible / Stranded wire with end ferrules	mm ²
Tightening torque range (clamping screw)	
Stripping length / Blade size	mm/-
Note	

Ordering data

Version	
	Without LED
Note	

Accessories

Screwable cross-connection	
	2-pole
	3-pole
	4-pole
	10-pole
Mounting screw	
Lock washer	
Screw cover cap	
	SK
Gauge rings	
Fuse cartridges	

Marking systems	
(see assortment in catalogue 7)	
Marking tags	
For detailed information on other accessories and applications, refer to the „Accessories“ section	

SAKS 2/35

10 mm²

27.6 x 80 x 75	
10 / 16	
0.33...16	

IEC 60947-7-3

IEC	UL	CSA
500		600
10		25
10		AWG 22...8
		6 / 3
		B6 / 5VA



Rated connection	
0.5...16 / 0.5...10	
0.5...10 / 0.5...10	
1.2...2.4 Nm (M 4)	
12 / 1.0 x 5.5 mm	

Connections for stranded conductors from 10 mm² and 7-wire AWG conductors require a tightening torque of 2 Nm.

Type	Qty.	Order No.
SAKS 2/35	20	1368720000

Type	current	Qty.	Order No.
QL 2 SAKS2	47 A	20	0207800000
QL 3 SAKS2	47 A	20	0207900000
QL 4 SAKS2	47 A	20	0208000000
QL 10 SAKS2	47 A	20	0338900000
BFSC M4X9T		100	0103300000
SS M4 D 128-A 4		100	0136400000
Width			
SK E16/SAKS2		25	0284110000
P 16/10 RT SAKS2		100	0208900000
P 16/16 GR SAKS2		100	0209000000
P 16/20 BL SAKS2		100	0209100000
E 16/10A RT TNDZ		25	0208500000
E 16/16A GR TNDZ		25	0208600000
E 16/20A BL TNDZ		25	0208700000
E 16/25A GE TNDZ		25	0208800000

Marking systems	
(see assortment in catalogue 7)	
Marking tags	
For detailed information on other accessories and applications, refer to the „Accessories“ section	

DEK 5/5

SAKS 4/35

10 mm²

D 01-fuses



24 x 75 x 66	
16 / 16	
0.33...16	

IEC 60947-7-3

IEC	UL	CSA
400		600
16		30
10		AWG 22...8
		6 / 3
		B6 / 5VA



Rated connection	
0.5...16 / 1.5...10	
0.5...10 / 0.5...10	
1.2...2.4 Nm (M 4)	
14 / 1.0 x 5.5 mm	

Connections for stranded conductors from 10 mm² and 7-wire AWG conductors require a tightening torque of 2 Nm.

Type	Qty.	Order No.
SAKS 4/35	20	0501820000

Type	current	Qty.	Order No.
QL 2 SAKS4	36 A	20	0328000000
QL 3 SAKS4	36 A	20	0328100000
QL 4 SAKS4	36 A	20	0328200000
QL 10 SAKS4	36 A	20	0339000000
BFSC M4X9T		100	0103300000
SS M4 D 128-A 4		100	0136400000
Width			
SK E14 SAKS4		20	0339410000
P 14/2 D01 RS SAKS4		50	0138000000
P 14/4 D01 BR SAKS4		50	0138100000
P 14/10 D01 RT SAKS4		50	0328700000
P 14/6 D01 GN SAKS4		50	0328600000
E 14/2A RS		10	0137400000
E 14/4A BR		10	0137500000
E 14/6A GN		10	0328300000
E 14/10A RT		10	0328400000
E 14/16A GR		10	0328500000

Marking systems	
(see assortment in catalogue 7)	
Marking tags	
For detailed information on other accessories and applications, refer to the „Accessories“ section	

DEK 5/5

SAKS 4/35 USA

10 mm²

1 1/4" x 1/4"



24 x 75 x 73
30 / 16
0.5...16

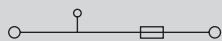

IEC	UL	CSA
400	600	600
16	30	30
10	AWG 20...8	AWG 22...8
6 / 3		
B6 / 5VA		

Rated connection	
0.5...16 / 1.5...10	
0.5...10 / 0.5...10	
1.2...2.4 Nm (M 4)	
14 / 1.0 x 5.5 mm	

Connections for stranded conductors from 10 mm² and 7-wire AWG conductors require a tightening torque of 2 Nm.

Type	Qty.	Order No.
SAKS 4/35 USA	20	0178220000

Type	current	Qty.	Order No.
QL 2 SAKS4	36 A	20	0328000000
QL 3 SAKS4	36 A	20	0328100000
QL 4 SAKS4	36 A	20	0328200000
QL 10 SAKS4	36 A	20	0339000000
BFSC M4X9T		100	0103300000
SS M4 D 128-A 4		100	0136400000
Width			
SK E14 SAKS4 USA		1	2012790000

DEK 5/5

SAKS 5/35

16 mm²

D 02 - fuse



28 x 80 x 66
63 / 16
1.5...16

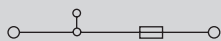

IEC 60947-7-3

IEC	UL	CSA
400	600	600
63	40	63
16	AWG 14...6	AWG 14...6
6 / 3		
B7 / 5VA		

Rated connection	
1.5...16 / 1.5...16	
1.5...16 / 1.5...16	
1.2...2.4 Nm (M 4)	
13 / 1.0 x 5.5 mm	

Connections for stranded conductors from 10 mm² and 7-wire AWG conductors require a tightening torque of 2 Nm.

Type	Qty.	Order No.
SAKS 5/35	20	0502120000

Type	current	Qty.	Order No.
QL 2 SAKS2	47 A	20	0207800000
QL 3 SAKS2	47 A	20	0207900000
QL 4 SAKS2	47 A	20	0208000000
QL 10 SAKS2	47 A	20	0338900000
BFSC M4X9T		100	0103300000
SS M4 D 128-A 4		100	0136400000
Width			
SK E18 SAKS5		20	0359310000
P 18/20 D02 BL SAKS5	50		0361800000
P 18/25 D02 GE SAKS5	50		0361900000
P 18/35 D02 SW SAKS5	50		0362000000
P 18/50 D02 WS SAKS5	50		0362100000
E 18/20A BL	10		0361300000
E 18/25A GE	10		0361400000
E 18/50A WS	10		0361600000
E 18/63A KU	10		0361700000

DEK 5/5

Partition wall TW HP (2.0) order no. 0607000000 only for TS 32

Fuse inserts

Technical data

for terminal type

SAKS 1
SAKS 7
ASK 1
WSI 6



G fuse inserts 5 x 20 without indicator acc. to IEC 60127-2 (VDE 0820 T.2 Bl 1)

Size (mm)	Rated voltage (V)	Rated current (A)	Type
5 x 20 Breaking capacity 1500 A (at 250 V, 50 Hz, cos φ 0.7)	250	0.1	(F) G 20/0.10A/F
		0.2	(F) G 20/0.20A/F
		0.25	(F) G 20/0.25A/F
		0.5	(F) G 20/0.50A/F
		0.63	(F) G 20/0.63A/F
		1.0	(F) G 20/1.00A/F
		1.6	(F) G 20/1.60A/F
		2.0	(F) G 20/2.00A/F
		2.5	(F) G 20/2.50A/F
		3.15	(F) G 20/3.15A/F
		4.0	(F) G 20/4.00A/F
		5.0	(F) G 20/5.00A/F
		6.3	(F) G 20/6.30A/F
		(M) = medium-delayed action (F) = fast	

Order data

Qty.	Order No.
10	0430300000
10	0430400000
10	0430500000
10	0430600000
10	0439000000
10	0430700000
10	0430800000
10	0430900000
10	0431000000
10	0431100000
10	0431200000
10	0431300000
10	0431400000

G fuse inserts 5 x 25 with indicator acc. to DIN 41576 1)

SAKS 1
SAKS 7
WSI 6



Size (mm)	Rated voltage (V)	Rated current (A)	Type	
5 x 25 m. K.1) Breaking capacity 80 A (at 250 V, 50 Hz, cos φ = 1)	250	0.25	(M) G 25/0.25A/M	
		0.5	(M) G 25/0.50A/M	
		0.8	(M) G 25/0.80A/M	
		1	(M) G 25/1.00A/M	
		10	(M) ²⁾ G 25/10.0A/M	
		2	(F) G 25/2.00A/F	
		4	(F) G 25/4.00A/F	
		6.3	(F) G 25/6.30A/F	
		(M) = medium-delayed action (F) = fast		

10	0546900000
10	0510300000
10	0646400000
10	0265800000
10	0193100000
10	0192700000
10	0192800000
10	0192900000

Fuse inserts 1 1/4" x 1/4" without indicator acc. to BS 88

SAKS 3²⁾
SAKS 6



Size (mm)	Rated voltage (V)	Rated current (A)	Type	
33 kA Breaking capacity 33 kA fast	440	0.5	GZ 0.5A/F	
		1	GZ 1.0A/F	
		2	GZ 2.0A	
		3	GZ 3.0A	
		5	GZ 5.0A	
		7	GZ 7.0A	
		10	GZ 10.0A	
		12.5	GZ 12.5A/FF	
		(F) = fast (M) = medium-delayed action		

10	0533800000
10	0525500000
10	0294500000
10	0295700000
10	0294600000
10	0295800000
10	0293900000
10	0245400000

D fuse inserts E 16 with indicator acc. to DIN 49360 (diazed)

SAKS 2



Size (mm)	Rated voltage (V)	Rated current (A)	Type
E 10 A E 16 A E 20 A E 25 A	500	10	E 16/10A RT
		16	E 16/16A GR
		20	E 16/20A BL
		25	E 16/25A GE
(F) = fast (M) = medium-delayed action			

25	0208500000
25	0208600000
25	0208700000
25	0208800000

D fuse inserts E 14 Size D 01 and E 18 size D 02 with indicator acc. to DIN 49522 (neozed)³⁾

SAKS 4 ⁴⁾



SAKS 5



Size (mm)	Rated voltage (V)	Rated current (A)	Type
E 14/2 E 14/4 E 14/6 E 14/10 E 14/16	400	2	E 14/2A RS
		4	E 14/4A BR
		6	E 14/6A GN
		10	E 14/10A RT
		16	E 14/16A GR
		E 18/20 E 18/25 E 18/35 E 18/50 E 18/63	400
25	E 18/25A GE		
35	E 18/35A SW		
50	E 18/50A WS		
63	E 18/63A KU		
(F) = fast (M) = medium-delayed action			

10	0137400000
10	0137500000
10	0328300000
10	0328400000
10	0328500000
10	0361300000
10	0361400000
10	0361500000
10	0361600000
10	0361700000

Note: 1) The SIBA company also supplies 5 x 25 G fuse inserts with indicators in a shipbuilding model for 450 V AC.
2) 5 x 30 (500 V AC) fuse inserts for SAKS 3 are available from the WICKMANN company
3) The LINDNER company also supplies neozed fuse cartridges in an additional shipbuilding mode for 440 V AC.
4) Fuse cartridges with the dimensions 1"x1/4" ≅ 25.4x6.35 mm and 13/32"x1/2" ≅ 10.3x38.1 mm are not included in product line.
5) Only for SAKS 1 and SAKS 7.

Gauge rings

Technical data

for terminal type

SAKS 4 and 4/35



SAKS 5 and 5/35



SAKS 2 and 2/35



Gauge ring type	Amp.	Colour	Type
P 14/2	2	pink	P 14/2D01 RS
P 14/4	4	brown	P 14/4D01 BR
P 14/6	6	green	P 14/6D01 GN
P 14/1	10	red	P 14/10D01 RT
P 18/20	20	blue	P 18/20D02 BL
P 18/25	25	yellow	P 18/25D02 GE
P 18/35	35	black	P 18/35D02 SW
P 18/50	50	white	P 18/50D02 WS
P 16/10	10	red	P 16/10 RT
P 16/16	16	grey	P 16/16 GR
P 16/20	20	blue	P 16/20 BL

Order data

Qty.	Order No.
50	0138000000
50	0138100000
50	0328600000
50	0328700000
50	0361800000
50	0361900000
50	0362000000
50	0362100000
100	0208900000
100	0209000000
100	0209100000

Installation terminals

TS 35 / PA

These NT modular terminals are prescribed for insulation measurements without detaching the conductors according to VDE standards for places of public assembly.

In hazardous area applications, the installation instructions and the rated data specifications for accessories given in the technical appendix must be followed.

Width/Length/height with TS35x7.5	mm
max. current / max. cond. cross-section	A/mm ²
Max. clamping range	mm ²

Technical data

Rated data

Rated voltage	V
Rated current	A
Rated cross-section	mm ²
Rated impulse voltage / Pollution severity	kV/-
Gauge to IEC 60947-1 / UL94 Flammability class	Approvals

Clamped conductors (H05V/H07V)

solid / stranded	mm ²
flexible / Stranded wire with end ferrules	mm ²
Tightening torque range (clamping screw)	
Stripping length / Blade size	mm/-

Note

Ordering data

Version

	Blue
--	------

Note

Accessories

Support bracket for 10 x 3 (required every 20 cm)

	Blue
--	------

Busbar 10 x 3 (140 A)

OK, Busbar up to OK, TS35 = 25,5 mm

Clamping yoke for power supply to 10 x 3 busbars

	Rigid / flexible 0,5 - 6 / 4 mm ²
	rigid / flexible 6 - 16 mm ²
	Flexible 16 - 35 mm ²

NT 2.5/35

2.5 mm²

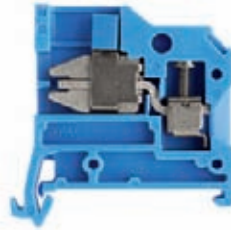

6 x 45 x 44

24 / 4
0.33...4



IEC 60947-7-1

IEC	UL	CSA
400	300	300
24	20	25
2.5	AWG 22...12	AWG 22...12
6 / 3		
A3 / V2		



Rated connection

0.5...4 / 0.5...4
0.5...0.5 / 0.5...2.5
0.5...0.8 Nm (M 2.5)
10 / 0.6 x 3.5 mm

Tightening torque via disconnecter is 0.5 ... 0.8 Nm.

Type	Qty.	Order No.
NT 2.5/35 10X3 BL	100	0471780000

Type	Width	Qty.	Order No.
HP NT2.5 BL	1.5 mm	20	0352080000

SSCH 10X3X1000 CU/SN	10 mm	1	0348900000
----------------------	-------	---	------------

ZB 4	5.6 mm	50	0316500000
ZB 16 ZKSC	10 mm	50	0316600000
ZB 35/M6X16	14 mm	20	0266500000

NT 6/35

6 mm²

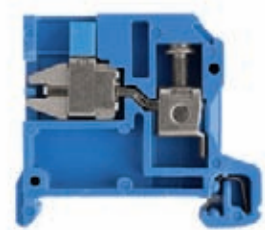

8 x 49 x 44

41 / 10
0.5...10



IEC 60947-7-1

IEC	UL	CSA
400	300	300
41	40	40
6	AWG 22...8	AWG 20...10
6 / 3		
A5 / 5VA		



Rated connection

0.5...10 / 0.5...10
0.5...10 / 0.5...6
0.8...1.4 Nm (M 3.5)
12 / 0.8 x 4 mm

Tightening torque via disconnecter is 0.5 ... 0.8 Nm.

Type	Qty.	Order No.
NT 6/35 10X3 KRG/BL	100	0501470000

Type	Width	Qty.	Order No.
HP NT6/10 BL	1.5 mm	20	0352880000

SSCH 10X3X1000 CU/SN	10 mm	1	0348900000
----------------------	-------	---	------------

ZB 4	5.6 mm	50	0316500000
ZB 16 ZKSC	10 mm	50	0316600000
ZB 35/M6X16	14 mm	20	0266500000

Marking systems (see assortment in catalogue 7)

Marking tags

For detailed information on other accessories and applications, refer to the „Accessories“ section

DEK 5/6

Refer to the „Accessories“ section for PEN bridges and additional clamping-yoke versions. Use of twin wire-end ferrules on request.

DEK 5/6

Refer to the „Accessories“ section for PEN bridges and additional clamping-yoke versions. Use of twin wire-end ferrules on request.

NT 10/35

10 mm²



10 x 45 x 44
57 / 16
0.5...16



IEC 60947-7-1

IEC	UL	CSA
400	300	300
57	50	50
10	AWG 14...8	AWG 14...8
	6 / 3	
	B6 / V2	



Rated connection

0.5...16 / 0.5...10
 0.5...10 / 0.5...10
 1.2...1.6 Nm (M 4)
 12 / 1.0 x 5.5 mm

Tightening torque via disconnecter is 0.5 ... 0.8 Nm. Fix 10 mm² stranded connection with 2 Nm tightening torque.

NT 16/35

16 mm²

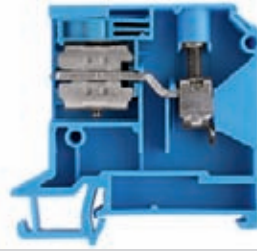

12 x 59.5 x 58
76 / 16
2.5...16



IEC 60947-7-1

IEC	UL	CSA
400	300	300
76	65	70
16	AWG 16...6	AWG 12...6
	6 / 3	
	B6 / V2	



Rated connection

2.5...16 / 2.5...10
 2.5...16 / 2.5...2.5
 1.2...1.6 Nm (M 4)
 12 / 1.0 x 5.5 mm

Isolator can accommodate 0.8...1.4 Nm. 10 and 16 mm² stranded and AWG B/7 connections are to be fixed with 2.4 Nm tightening torque.

Type	Qty.	Order No.
NT 10/35 10X3 BL	50	0471880000

Type	Qty.	Order No.
NT 16/35 10X3 BL	50	0499280000

Type	Width	Qty.	Order No.
HP NT6/10 BL	1.5 mm	20	0352880000
SSCH 10X3X1000 CU/SN	10 mm	1	0348900000
ZB 4	5.6 mm	50	0316500000
ZB 16 ZKSC	10 mm	50	0316600000
ZB 35/M6X16	14 mm	20	0266500000

Type	Width	Qty.	Order No.
HP NT16/10X3	2 mm	20	1266380000
SSCH 10X3X1000 CU/SN	10 mm	1	0348900000
ZB 4	5.6 mm	50	0316500000
ZB 16 ZKSC	10 mm	50	0316600000
ZB 35/M6X16	14 mm	20	0266500000

DEK 5/6

Refer to the „Accessories“ section for PEN bridges and additional clamping-yoke versions. Use of twin wire-end ferrules on request.

DEK 5/5

Refer to the „Accessories“ section for PEN bridges and additional clamping-yoke versions. Use of twin wire-end ferrules on request.

Test-disconnect terminals

TS 35 / KrG

In hazardous area applications, the installation instructions and the rated data specifications for accessories given in the technical appendix must be followed.

Width/Length/height with TS35x7.5	mm
max. current / max. cond. cross-section	A/mm ²
Max. clamping range	mm ²

Technical data

Rated data	
Rated voltage	V
Rated current	A
Rated cross-section	mm ²
Rated impulse voltage / Pollution severity	kV/-
Gauge to IEC 60947-1 / UL94 Flammability class	
Approvals	
Clamped conductors (H05V/H07V)	
solid / stranded	mm ²
flexible / Stranded wire with end ferrules	mm ²
Tightening torque range (clamping screw)	
Tightening torque range	
Stripping length / Blade size	mm/-

Note

Ordering data

Version	
Without socket	
With open rear wall for cross-connection	
With 2 sockets	
With 4 sockets	

Note

Accessories

Screwable cross-connection	
2-pole	
3-pole	
4-pole	
10-pole	
Connecting sleeve	
Mounting screw	

End plate / Partition plate	
Medium yellow	
beige	

Small partition	
Small partition	

Cross-connection slider	
2-pole	
3-pole	
4-pole	
Connecting sleeve for QVS	
Mounting screw for QVS	

Testing / Checking	
Test plug	
Socket	

Miscellaneous accessories	
Lockout device	
Short-circuit plug, 2-pole	

Marking systems	
(see assortment in catalogue 7)	

For detailed information on other accessories and applications, refer to the „Accessories“ section

SAKT 1/LT

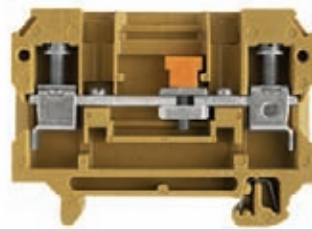
6 mm²

8 x 65 x 52.5

57 / 10

0.13...10



IEC 60947-7-1

IEC	UL	CSA
400	300	300
41	25	25
6	AWG 22...8	AWG 26...8
6 / 3		
A5 / 5VA		



Rated connection

0.5...10 / 1.5...10

0.5...6 / 0.5...6

0.8...1.6 Nm (M 3.5)

0.5...0.8 Nm

12 / 4.0 x 0.8 mm

10 mm² stranded and AWG 8/7 connections are to be fixed with 1.6 Nm tightening torque.

Type	Qty.	Order No.
SAKT 1/35/LT	50	0105420000
SAKT 1/35/LT STB	50	0105620000

Type	current	Qty.	Order No.
QL 2 SAK6N	57 A	50	0194300000
QL 3 SAK6N	57 A	50	0194400000
QL 4 SAK6N	57 A	50	0194500000
QL 10 SAK6N	57 A	20	0338300000
VH 12/4.9/3.3 SAK6N		100	0249000000
KISC M3X20 SAK10 CU5		100	0377100000

Width	
AP SAKB/C/T KRG	3 mm 20 0146720000
TW SAKB/C/T1	1.5 mm 20 0242960000

Width	
TSCH 2	0.6 mm 100 0353660000

current	
QVS 2 SAKT1+2	20 0307300000
QVS 3 SAKT1+2	20 0329300000
QVS 4 SAKT1+2	20 0307400000
VH 19/6/4.2 SAKT1	50 0318000000
BS 25 O.IH SAKT1	50 0334700000

Width	
PS 4 F.STB 4	7.6 mm 20 0299600000
STB 14/D6/4/M3 SAK10	50 0169900000

SSP 3 SAKT1	100	0531760000
QS 2/8/4	20	0270960000

DEK 5/6.5

To safe the test sockets use the SDIZ-blade (see chapter Tools) or bits with pilots!

SAKT 1/DU1

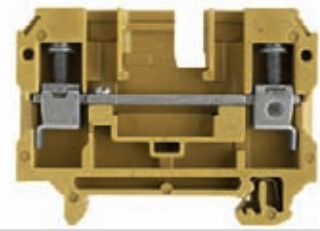
6 mm²

8 x 65 x 52.5

57 / 10

0.13...10

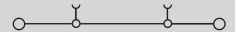

IEC 60947-7-1

IEC	UL	CSA
400	300	300
41	25	25
6	AWG 22...8	AWG 26...8
6 / 3		
A5 / 5VA		



Rated connection

0.5...10 / 1.5...10

0.5...6 / 0.5...6

0.8...1.6 Nm (M 3.5)

12 / 4.0 x 0.8 mm

10 mm² stranded and AWG 8/7 connections are to be fixed with 1.6 Nm tightening torque.

Type	Qty.	Order No.
SAKT 1/35/DU1	50	0105820000

Type	current	Qty.	Order No.
QL 2 SAK6N	32 A	50	0194300000
QL 3 SAK6N	57 A	50	0194400000
QL 4 SAK6N	57 A	50	0194500000
QL 10 SAK6N	32 A	20	0338300000
VH 12/4.9/3.3 SAK6N		100	0249000000
KISC M3X20 SAK10 CU5		100	0377100000

Width	
AP SAKB/C/T KRG	3 mm 20 0146720000
TW SAKB/C/T1	1.5 mm 20 0242960000

Width	
TSCH 2	0.6 mm 100 0353660000

current	
QVS 2 SAKT1+2	41 A 20 0307300000
QVS 3 SAKT1+2	41 A 20 0329300000
QVS 4 SAKT1+2	41 A 20 0307400000
VH 19/6/4.2 SAKT1	50 0318000000
BS 25 O.IH SAKT1	50 0334700000

Width	
PS 4 F.STB 4	7.6 mm 20 0299600000
STB 14/D6/4/M3 SAK10	50 0169900000

SSP 3 SAKT1	100	0531760000
QS 2/8/4	20	0270960000

DEK 5/6.5

To safe the test sockets use the SDIZ-blade (see chapter Tools) or bits with pilots!

SAKT 1/QT

6 mm²

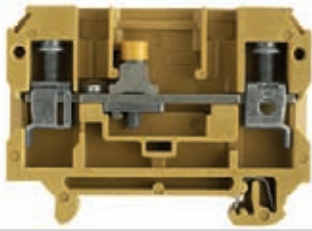

8 x 65 x 52.5
57 / 10
0.13...10

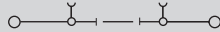

IEC 60947-7-1

IEC	UL	CSA
400	300	300
41	25	25
6	AWG 22...8	AWG 26...8
6 / 3		
A5 / 5VA		



Rated connection

0.5...10 / 1.5...10
0.5...6 / 0.5...6
0.8...1.6 Nm (M 3.5)
0.5...0.8 Nm
12 / 4.0 x 0.8 mm

10 mm² stranded and AWG 8/7 connections are to be fixed with 1.6 Nm tightening torque.

Type	Qty.	Order No.
SAKT 1/35/QT2	50	0124620000
SAKT 1/35/QT1	50	0105720000

Type	current	Qty.	Order No.
QL 2 SAK6N	57 A	50	0194300000
QL 3 SAK6N	57 A	50	0194400000
QL 4 SAK6N	57 A	50	0194500000
QL 10 SAK6N	57 A	20	0338300000
VH 12/4.9/3.3 SAK6N		100	0249000000
KISC M3X20 SAK10 CU5		100	0377100000
Width			
AP SAKB/C/T KRG	3 mm	20	0146720000
TW SAKB/C/T1	1.5 mm	20	0242960000
current			
QVS 2 SAKT1+2		20	0307300000
QVS 3 SAKT1+2		20	0329300000
QVS 4 SAKT1+2		20	0307400000
VH 19/6/4.2 SAKT1		50	0318000000
BS 25 O.IH SAKT1		50	0334700000
Width			
PS 4 F.STB 4	7.6 mm	20	0299600000
STB 14/D6/4/M3 SAK10		50	0169900000
SSP 3 SAKT1		100	0531760000
QS 2/8/4		20	0270960000

DEK 5/6,5

To safe the test sockets use the SDIZ-blade (see chapter Tools) or bits with pilots!

SAKT 2/LT

6 mm²

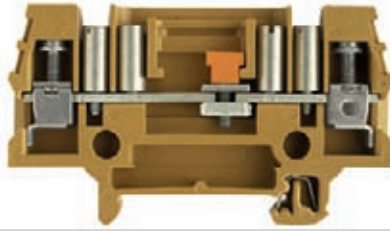

8 x 82 x 52.5
46 / 10
0.5...10

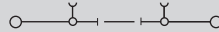

IEC 60947-7-1

IEC	UL	CSA
125	300	
41	25	
6	AWG 22...8	
6 / 3		
A5 / 5VA		



Rated connection

0.5...10 / 1.5...10
0.5...6 / 0.5...6
1.2...1.6 Nm (M 3.5)
0.5...0.8 Nm
12 / 4.0 x 0.8 mm

10 mm² stranded and AWG 8/7 connections are to be fixed with 1.6 Nm tightening torque.

Type	Qty.	Order No.
SAKT 2/35/LT/STB	50	0105920000
SAKT 2/35/LT 4STB	50	0106020000

Type	current	Qty.	Order No.
QL 2 SAK6N	32 A	50	0194300000
QL 3 SAK6N	57 A	50	0194400000
QL 4 SAK6N	57 A	50	0194500000
QL 10 SAK6N	32 A	20	0338300000
VH 12/4.9/3.3 SAK6N		100	0249000000
Width			
TW SAKT2	2.5 mm	20	0351820000
current			
QVS 2 SAKT1+2	41 A	20	0307300000
QVS 3 SAKT1+2	41 A	20	0329300000
QVS 4 SAKT1+2	41 A	20	0307400000
VH 19/6/4.2 SAKT1		50	0318000000
BS 25 O.IH SAKT1		50	0334700000
Width			
PS 4 F.STB 4	7.6 mm	20	0299600000
STB 14/D6/4/M3 SAK10		50	0169900000
SSP 3 SAKT1		100	0531760000
QS 2/8/4		20	0270960000

DEK 5/6,5

To safe the test sockets use the SDIZ-blade (see chapter Tools) or bits with pilots!

SAKT 4/35/LT

4 mm²

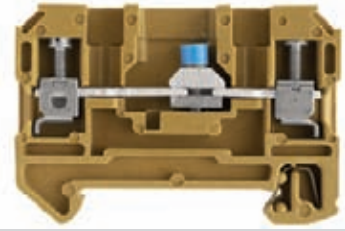

6 x 57.2 x 40
41 / 6
0.13...6

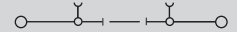

IEC 60947-7-1

IEC	UL	CSA
400	300	300
32	20	20
4	AWG 22...12	AWG 26...10
6 / 3		
A3 / 5VA		



Rated connection

0.5...6 / 1.5...4
0.5...4 / 0.5...4
0.4...0.7 Nm (M 2.5)
0.4...0.7 Nm
10 / 0.6 x 3.5 mm

Two conductors with the same cross-section can be accommodated. 1.5 mm² solid and 0.5...1.5 mm² flexible

Type	Qty.	Order No.
SAKT 4/35/LT O.STB	50	1272420000
SAKT 4/35/LT STB2.0	50	1272520000

Type	current	Qty.	Order No.
QL 2 SAK2.5	41 A	100	0155900000
QL 3 SAK2.5	41 A	100	0156000000
QL 4 SAK2.5	41 A	50	0156100000
QL 10 SAK2.5	41 A	20	0338100000
VH 8/4.9/3.3 SAK2.5		100	0266700000
KISC M3X15/6 SAK2.5 CU5		100	0377200000
Width			
TW AST1/PA HP/DBR/0.5	0.5 mm	20	0474700000
current			
QVS 2/4 SAKT4		20	1319260000
Width			
VH 16/5/3.5 SAK10-35		50	0309700000
BFSC M3X22 SAKT4		50	1319900000
Width			
PS 2.0 OR	5.4 mm	20	0293800000
STB 8.5/D4.5/2/M3 SAKT4		50	0244600000
SSP 4 SAKT4		20	1319360000

DEK 5/6,5

To safe the test sockets use the SD-blade or bits with pilots!

Terminals for temperature measuring circuits

TS 35 / PA

Busbars made from thermocouple materials according to DIN IEC 584

In hazardous area applications, the installation instructions and the rated data specifications for accessories given in the technical appendix must be followed.

Width/Length/height with TS35x7.5	mm
max. current / max. cond. cross-section	A/mm ²
Max. clamping range	mm ²

Technical data

Rated data	
Rated voltage	V
Rated current	A
Rated cross-section	mm ²
Rated impulse voltage / Pollution severity	kV/-
Gauge to IEC 60947-1 / UL94 Flammability class	
Approvals	
Clamped conductors (H05V/H07V)	
solid / stranded	mm ²
flexible / Stranded wire with end ferrules	mm ²
Tightening torque range (clamping screw)	
Stripping length / Blade size	mm/-
Note	

Ordering data

Version	
	(NiCr - Ni) type K
	(Cu - CuNi) type T
	(Fe-CuNi) type J
Note	

Accessories

End plate / Partition plate	
	beige
	beige
	Dark beige Wemid

Marking systems (see assortment in catalogue 7)
Marking tags

For detailed information on other accessories and applications, refer to the „Accessories“ section

DK 4 Q/TC

4 mm²

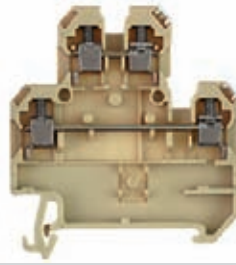

6 x 54 x 59.5
/ 4
...4

IEC 60947-7-1 / IEC 60584

IEC	UL	CSA
4		
A3 / V2		
Rated connection		
0.5...4 / 1.5...4		
0.5...4 / 0.5...2.5		
0.5...1.0 Nm (M 3)		
9 / 0.6 x 3.5 mm		

Type	Qty.	Order No.
DK 4Q/35/TC TYP K	100	1284160000
DK 4Q/35/TC TYP T	100	1285660000
DK 4Q/35/TC TYP J	100	1284060000

Type	Width	Qty.	Order No.
AP DK4Q	1.5 mm	20	1397160000
TW SAKS2 HP/DBR/2	2 mm	20	0607000000
WTW EN	3 mm	20	1058800000

DEK 5/6

Weidmüller thermocouple terminals are specially designed for the transmission of very small voltages in temperature measuring circuits. Special current bars ensure that no false signals are transmitted within the terminal when temperature differences between the positive and negative paths exist. This high measuring precision is required, for example, in aircraft engine test rigs, complicated chemical processes, controllers, etc.

- Material of current bar corresponds to thermal and compensating conductors
- Clear thermocouple marking
- 2-pole blocks per thermocouple
- Modular width 10 mm

Configuration of a temperature measuring circuit

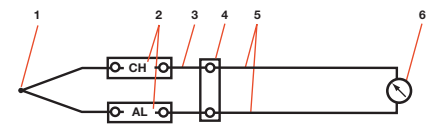

- | | |
|--------------------------|--------------------------------|
| 1 Thermocouple (sensor) | 4 Reference junction |
| 2 Thermocouple terminals | 5 Supply and return conductors |
| 3 Compensating conductor | 6 Measuring instrument |

The thermocouple terminals shown in this measuring circuit are used for the thermoelectrical transmission of the thermoelectric voltage from the thermocouple to the reference junction and the indicator unit via the compensating conductor. Thermocouple terminals are required for constructing a temperature measuring circuit.

Technical data

Thermocouples to IEC 584 (DIN 43 710)

Terminal	Busbar material trade name
a) Type J	
Fe (positive leg)	Iron
CuNi (negative leg)	Constantan
b) Type T	
Cu (positive leg)	Copper
CuNi (negative leg)	Constantan
c) Type K	
NiCr (positive leg)	Chromel
Ni (negative leg)	Alumel

Terminals with screw-less connections

With tab connection
TS 35 / PA

In hazardous area applications, the installation instructions and the rated data specifications for accessories given in the technical appendix must be followed.

Width/Length/height with TS35x7.5	mm
max. current / max. cond. cross-section	A/mm ²
Max. clamping range	mm ²

Technical data

Rated data	
Rated voltage	V
Rated current	A
Rated cross-section	mm ²
Rated impulse voltage / Pollution severity	kV/-
Gauge to IEC 60947-1 / UL94 Flammability class	
Approvals	
Clamped conductors (H05V/H07V)	
solid / stranded	mm ²
flexible / Stranded wire with end ferrules	mm ²
Tightening torque range (clamping screw)	
Stripping length / Blade size	mm/-
Note	

Ordering data

Version	
	Slotted
	Not slit
Note	

Accessories

Screwable cross-connection	
	2-pole
	3-pole
	4-pole
	10-pole
Plug-in adapter	
	2-pole
	3-pole
	4-pole
	5-pole
	8-pole
End plate / Partition plate	
	beige
	Medium yellow
	beige
Small partition	
	Small partition
Testing / Checking	
	Test plug
	Socket
Insulating sleeve	
	2,8
	6,3

Marking systems	
	(see assortment in catalogue 7)
	Marking tags
For detailed information on other accessories and applications, refer to the „Accessories“ section	

AST 1 / 35

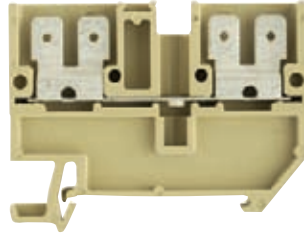
2.5 mm²

6.5 x 58 x 46	6.3 6.3 2.8 2.8	6.3 6.3 2.8 2.8
20 / 2.5		
0.5...2.5		

IEC 60947-7-1 / IEC 61210

IEC	UL	CSA
500	600	300
20	13	16
2.5		
	6 / 3	
	/ V2	



Rated connection

0.5...2.5

The rated voltage is 800 V when using a cable-lug (flat) connector with IH 6.3 insulating sleeves.

Type	Qty.	Order No.
AST 1/35 6.3/2.8	50	0699660000
AST 1/35 6.3	50	0664860000

Cable-lug connections should be connected with insulating sleeves. 20 A with F 6.3 or 2 x F 2.8

Type	current	Qty.	Order No.
Q 2 SAK4	41 A	50	0336700000
Q 3 SAK4	41 A	50	0336800000
Q 4 SAK4	41 A	50	0336900000
Q 10 SAK4	41 A	20	0368800000
Width			
AP AST1+5 DB	1.5 mm	20	0266400000
TW SAKS2 HP/DBR/2	2 mm	20	0607000000
TSCH 1	2 mm	100	0319160000
PS 2.3 RT	5.4 mm	20	0180400000
STB 14/D5/2.3/M3 SAK2.5		50	0168600000
IH 2.8 DB		100	0386060000
IH 6.3 WEM GE		100	0386260000

DEK 5/6

AST 3/35

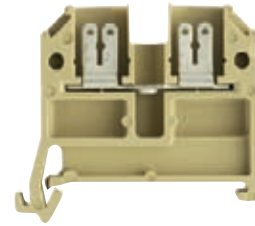
2.5 mm²

6.5 x 40 x 40.1	6.3 6.3 2.8 2.8	6.3 6.3 2.8 2.8
20 / 2.5		
...2.5		

IEC 60947-7-1 / IEC 61210

IEC	UL	CSA
500	300	300
20	13	16
2.5		
	6 / 3	
	/ V2	



Rated connection

0.5...2.5

Cable-lug connections should be fitted with insulating sleeves. 20 A with F 6.3 or 2 x F 2.8

Type	Qty.	Order No.
AST 3/35 6.3/2.8	100	0460360000
AST 3/35 6.3	100	0479360000

Type	current	Qty.	Order No.
Q 2 SAK4	41 A	50	0336700000
Q 3 SAK4	41 A	50	0336800000
Q 4 SAK4	41 A	50	0336900000
Q 10 SAK4	41 A	20	0368800000
Width			
STA 2.5/2		100	0165860000
STA 2.5/3		50	0165960000
STA 2.5/4		50	0190360000
STA 2.5/5		50	0166060000
STA 2.5/8		50	0166160000
AP AST3+4 KRG	3 mm	20	0298120000
TW 4 SAK4-10	1.5 mm	20	0130160000
TSCH 1	2 mm	100	0319160000
PS 2.3 RT	5.4 mm	20	0180400000
STB 14/D5/2.3/M3 SAK2.5		50	0168600000
IH 2.8 DB		100	0386060000
IH 6.3 WEM GE		100	0386260000

DEK 5/6

Pluggable adapter STA 2.5/2 - STA 2.5/8 only for PA - Version.

AST 4/35

2.5 mm²

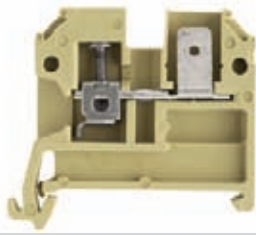

6.2 x 40 x 40.1
20 / 4
0.2...4

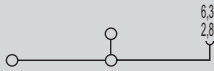

IEC 60947-7-1 / IEC 61210

IEC	UL	CSA
500	300	300
20	13	16
2.5	AWG 22...12	AWG 24...12
6 / 3		
A3 / V2		



Rated connection

0.5...4 / 1.5...2.5
0.5...2.5 / 0.5...2.5
0.4...0.7 Nm (M 2.5)
9 / 0.6 x 3.5 mm

The rated voltage is 800 V when using a cable-lug (flat) connector with IH 6.3 insulating sleeves.

Type	Qty.	Order No.
AST 4/35 SF 6.3/2.8	100	0460460000
AST 4/35 SF 6.3	100	0479460000

Cable-lug connections should be connected with insulating sleeves. 20 A with F 6.3 or 2 x F 2.8

Type	current	Qty.	Order No.
Q 2 SAK4	41 A	50	0336700000
Q 3 SAK4	41 A	50	0336800000
Q 4 SAK4	41 A	50	0336900000
Q 10 SAK4	41 A	20	0368800000
Width			
STA 2.5/2		100	0165860000
STA 2.5/3		50	0165960000
STA 2.5/4		50	0190360000
STA 2.5/5		50	0166060000
STA 2.5/8		50	0166160000
Width			
AP SAK2.5/35 + AST3+4	1.5 mm	20	0460560000
Width			
TW 4 SAK4-10	1.5 mm	20	0130160000
Width			
TSCH 1	2 mm	100	0319160000
Width			
PS 2.3 RT	5.4 mm	20	0180400000
STB 14/D5/2.3/M3 SAK2.5		50	0168600000
Width			
IH 2.8 DB		100	0386060000
IH 6.3 WEM GE		100	0386260000

DEK 5/6
Pluggable adapter STA 2.5/2 - STA 2.5/8 only for PA - Version.

AST 5/35

4 mm²

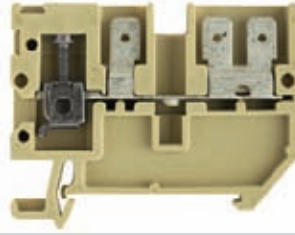

6.5 x 58 x 46
20 / 6
0.2...6

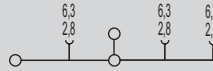

IEC 60947-7-1 / IEC 61210

IEC	UL	CSA
500	300	300
20	13	16
4	AWG 22...12	AWG 24...12
6 / 3		
A4 / V2		



Rated connection

0.5...6 / 1.5...2.5
0.5...4 / 0.5...4
0.5...1.0 Nm (M 3)
12 / 0.6 x 3.5 mm

The rated voltage is 800 V when using a cable-lug (flat) connector with IH 6.3 insulating sleeves.

Type	Qty.	Order No.
AST 5/35 SF 6.3/2.8	50	0664960000

Cable-lug connections should be connected with insulating sleeves. 20 A with F 6.3 or 2 x F 2.8

Type	current	Qty.	Order No.
Q 2 SAK4	41 A	50	0336700000
Q 3 SAK4	41 A	50	0336800000
Q 4 SAK4	41 A	50	0336900000
Q 10 SAK4	41 A	20	0368800000
Width			
AP AST1+5 DB	1.5 mm	20	0266400000
Width			
TW AST1/PA HP/DBR/0.5	0.5 mm	20	0474700000
Width			
PS 2.3 RT	5.4 mm	20	0180400000
STB 14/D5/2.3/M3 SAK2.5		50	0168600000
Width			
IH 2.8 DB		100	0386060000
IH 6.3 WEM GE		100	0386260000

DEK 5/6,5

SAK 4 S/35

4 mm²

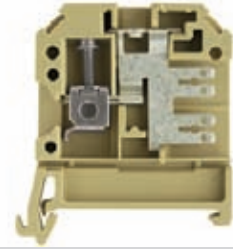

6.5 x 40 x 49.5
20 / 6
0.13...6

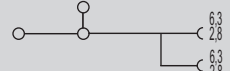

IEC 60947-7-1 / IEC 61210

IEC	UL	CSA
500	600	300
20	13	13
4	AWG 26...12	AWG 26...12
6 / 3		
A4 / V2		



Rated connection

0.5...6 / 1.5...4
0.5...4 / 0.5...4
0.5...1.0 Nm (M 3)
12 / 0.6 x 3.5 mm

The rated voltage is 800 V when using a cable-lug (flat) connector with IH 6.3 insulating sleeves.

Type	Qty.	Order No.
SAK 4 S/35 6.3/2.8	100	0630360000

Cable-lug connections should be connected with insulating sleeves. 20 A with F 6.3 or 2 x F 2.8

Type	current	Qty.	Order No.
QL 2 SAK4	32 A	100	0130600000
QL 3 SAK4	32 A	100	0130700000
QL 4 SAK4	32 A	50	0130800000
QL 10 SAK4	32 A	20	0338200000
Width			
AP SAK4-10	1.5 mm	20	0117960000
Width			
TW 4 SAK4-10	1.5 mm	20	0130160000
Width			
PS 2.3 RT	5.4 mm	20	0180400000
STB 14/D5/2.3/M3 SAK2.5		50	0168600000
Width			
IH 2.8 DB		100	0386060000
IH 6.3 WEM GE		100	0386260000

DEK 5/6,5

Terminals with screw-less connections

With tab connection
TS 35 / PA

In hazardous area applications, the installation instructions and the rated data specifications for accessories given in the technical appendix must be followed.

Width/Length/height with TS35x7.5	mm
max. current / max. cond. cross-section	A/mm ²
Max. clamping range	mm ²

Technical data

Rated data	
Rated voltage	V
Rated current	A
Rated cross-section	mm ²
Rated impulse voltage / Pollution severity	kV/-
Gauge to IEC 60947-1 / UL94 Flammability class	
Approvals	
Clamped conductors (H05V/H07V)	
solid / stranded	mm ²
flexible / Stranded wire with end ferrules	mm ²
Tightening torque range (clamping screw)	
Stripping length / Blade size	mm/-
Note	

Ordering data

Version	
	Slotted
	Not slit
Note	

Accessories

Screwable cross-connection	
	2-pole
	3-pole
	4-pole
	10-pole
Plug-in adapter	
	2-pole
	3-pole
	4-pole
	5-pole
	8-pole
End plate / Partition plate	
	beige
	Medium yellow
	beige
Small partition	
	Small partition
Testing / Checking	
	Test plug
	Socket
Insulating sleeve	
	2,8
	6,3

Marking systems	
	(see assortment in catalogue 7)
	Marking tags
For detailed information on other accessories and applications, refer to the „Accessories“ section	

SAK 4 SS/35

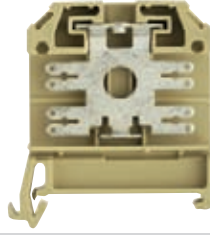
2.5 mm²

6.5 x 40 x 49.5
20 / 2.5
0.5...2.5

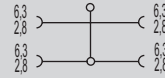

IEC 60947-7-1 / IEC 61210

IEC	UL	CSA
500	600	300
20	13	13
2.5	AWG 26...12	AWG 26...12
	6 / 3	
	/ V2	



Rated connection

0.5...2.5

The rated voltage is 800 V when using a cable-lug (flat) connector with IH 6.3 insulating sleeves.

Type	Qty.	Order No.
SAK 4 SS/35 6.3/2.8	100	0630460000
Note		
Cable-lug connections should be connected with insulating sleeves. 20 A with F 6.3 or 2 x F 2.8		

Type	current	Qty.	Order No.
QL 2 SAK4	32 A	100	0130600000
QL 3 SAK4	32 A	100	0130700000
QL 4 SAK4	32 A	50	0130800000
QL 10 SAK4	32 A	20	0338200000
Width			
AP SAK4-10	1.5 mm	20	0117960000
TW 4 SAK4-10	1.5 mm	20	0130160000
Testing / Checking			
IH 2.8 DB		100	0386060000
IH 6.3 WEM GE		100	0386260000

DEK 5/6,5

DK 4 SS/35

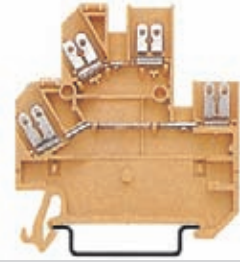
2.5 mm²

6 x 54 x 60.5
20 / 2.5
0.5...2.5

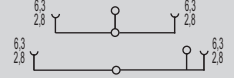

IEC 60947-7-1 / IEC 61210

IEC	UL	CSA
400	300	300
20	10	10
2.5	AWG 22...12	AWG 22...12
	4 / 3	
	/ V2	



Rated connection

0.5...2.5

Cable-lug connections should be fitted with insulating sleeves. 20 A with F 6.3 and 2 x F 2.8

Type	Qty.	Order No.
DK 4SS/35 FF 4X6.3/2.8	100	0217160000
Note		

Type	current	Qty.	Order No.
Q 2 AKZ4	32 A	50	0336400000
Q 3 AKZ4	32 A	50	0336500000
Q 4 AKZ4	32 A	50	0336600000
Q 10 AKZ4	32 A	20	0368600000
Width			
AP DK4S		20	0631360000
Testing / Checking			
TSCH 6 DK1 S4	5 mm	100	0190260000
PS 2.3 RT	5.4 mm	20	0180400000
STB 8.5/D4/2.3/M2.5 AKZ		50	0215700000
IH 2.8 DB		100	0386060000
IH 6.3 WEM GE		100	0386260000

DEK 5/6

DK 4 S

4 mm²

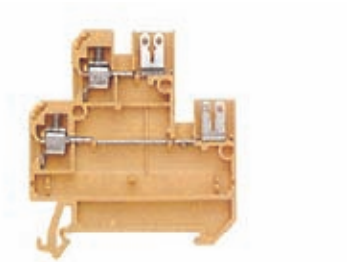

6 x 54 x 59.5

20 / 4

0.33...4

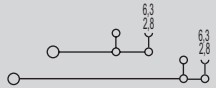

IEC 60947-7-1 / IEC 61210

IEC	UL	CSA
400	300	300
10	10	10
4	AWG 22...12	AWG 22...12
	6 / 3	
	A3 / V2	

CE, RoHS, REACH, UL

Rated connection

0.5...4 / 1.5...4

0.5...4 / 0.5...2.5

0.5...0.8 Nm (M 3)

8 / 0.6 x 3.5 mm

Cable-lug connections should be fitted with insulating sleeves. 20 A supplied via F 6.3 or 2 x F 2.8.

Type	Qty.	Order No.
DK 4S/35 SF 6.3/2.8	100	0686660000

Type	current	Qty.	Order No.
Q 2 AKZ4	32 A	50	0336400000
Q 3 AKZ4	32 A	50	0336500000
Q 4 AKZ4	32 A	50	0336600000
Q 10 AKZ4	32 A	20	0368600000

Width			
AP DK4S	20		0631360000
TSCH 6 DK1 S4	5 mm	100	0190260000
PS 2.3 RT	5.4 mm	20	0180400000
STB 8.5/D4/2.3/M2.5 AKZ		50	0215700000
IH 2.8 DB		100	0386060000
IH 6.3 WEM GE		100	0386260000

DEK 5/6

Terminals with screw-less connections

with solder connection
TS 35 / PA

SAK 2.5 LL

1.5 mm²

solder connection both sides



In hazardous area applications, the installation instructions and the rated data specifications for accessories given in the technical appendix must be followed.

Width/Length/height with TS35x7.5	mm
max. current / max. cond. cross-section	A/mm ²
Max. clamping range	mm ²

6 x 55 x 46.5

17.5 / 1.5

0.13...1.5

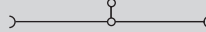

Technical data

Rated data

Rated voltage	V
Rated current	A
Rated cross-section	mm ²
Rated impulse voltage / Pollution severity	kV/-
Gauge to IEC 60947-1 / UL94 Flammability class	
Approvals	

Clamped conductors (H05V/H07V)

solid / stranded	mm ²
flexible / Stranded wire with end ferrules	mm ²
Tightening torque range (clamping screw)	
Stripping length / Blade size	mm/-

Note

IEC 60947-7-1 / IEC 60068-2-20

IEC	UL	CSA
250		300
17.5		10
1.5		AWG 26...12
		4 / 3
		/ V2



Rated connection

0.5...1.5
0.5...1.5

Solder connection both sides with max. 1.5 mm² conductor

Ordering data

Version

	beige
--	-------

Note

Type	Qty.	Order No.
SAK 2.5/35 LL	100	0567260000

Accessories

Screwable cross-connection



10-pole
2-pole
3-pole
4-pole

Testing / Checking

Socket
Test plug

End plate / Partition plate

beige
Blue
beige
Tropical applications

Small partition

Small partition

Cover / warning label

Cover / warning label
Mounting screw (plastic)

Type	current	Qty.	Order No.
Q 10 SAK2.5	41 A	20	0368700000
Q 2 SAK2.5	41 A	50	0337000000
Q 3 SAK2.5	41 A	50	0337100000
Q 4 SAK2.5	41 A	50	0337200000

Width

STB 8.5/5/2.3/M3 SAK2.5	50	0280600000
PS 2.3 RT	5.4 mm	0180400000

AP SAK2.5	1.5 mm	20	0279560000
AP SAK2.5 BL	1.5 mm	20	0279580000
TW SAK2.5	2.5 mm	20	0302860000
TW SAK2.5 HP/TF/GE/1	1 mm	20	0297100000

TSCH 1	2 mm	100	0319160000
--------	------	-----	------------

AD 4 AKZ4	50	0303400000
BFSC M3X22 PA/RT	100	0128900000

Marking systems (see assortment in catalogue 7)

Marking tags

For detailed information on other accessories and applications, refer to the „Accessories“ section

DEK 5/6

Special terminals - SAKG

TS 35 / KrG

In hazardous area applications, the installation instructions and the rated data specifications for accessories given in the technical appendix must be followed.

Width/Length/height with TS35x7.5	mm
max. current / max. cond. cross-section	A/mm ²
Max. clamping range	mm ²

Technical data

Rated data

Rated voltage	V
Rated current	A
Rated cross-section	mm ²
Rated impulse voltage / Pollution severity	kV/-
Gauge to IEC 60947-1 / UL94 Flammability class	
Approvals	

Clamped conductors (H05V/H07V)

solid / stranded	mm ²
flexible / Stranded wire with end ferrules	mm ²
Tightening torque range (clamping screw)	
Stripping length / Blade size	mm/-

Note

Ordering data

Version

Medium yellow

Note

Accessories

Screwable cross-connection



2-pole
3-pole
4-pole

End plate / Partition plate

dark brown
Tropical applications
dark brown
Tropical applications

Cover / warning label

Cover / warning label

SAKG 32 I

50 mm²

32 x 87 x 84.5

192 / 70

10...70



IEC 60947-7-1

IEC	UL	CSA
1000	600	600
150	165	170
50	AWG 6...3/0	AWG 1...2/0
8 / 3		
B11 / 5VA		

Rated connection

10...16 / 10...70
10...70 / 10...70
6.0...12 Nm (M 8)
26 /

Type	Qty.	Order No.
SAKG 32/35 I	10	0637120000

Type	current	Qty.	Order No.
QL 2 SAKG32+70	150 A	5	0194000000
QL 3 SAKG32+70	150 A	5	0441500000
QL 4 SAKG32+70	150 A	5	0441600000
Width			
EP 2 SAKG46/35 HP/DBR	2 mm	10	0180700000
EP 2 SAKG46/35 HP/TF/GE	2 mm	10	0180800000
TW SAKG46 HP/DBR/2	2 mm	10	0177100000
TW SAKG46 HP/TF/GE/2	2 mm	10	0179900000
AH 32 SAKG32	30 mm	5	0326760000

Marking systems (see assortment in catalogue 7)

Marking tags

For detailed information on other accessories and applications, refer to the „Accessories“ section

DEK 5/5

TS 35 / KrG

In hazardous area applications, the installation instructions and the rated data specifications for accessories given in the technical appendix must be followed.

Width/Length/height with TS35x7.5	mm
max. current / max. cond. cross-section	A/mm ²
Max. clamping range	mm ²

Technical data

Rated data	
Rated voltage	V
Rated current	A
Rated cross-section	mm ²
Rated impulse voltage / Pollution severity	kV/-
Gauge to IEC 60947-1 / UL94 Flammability class	Approvals
Clamped conductors (H05V/H07V)	
solid / stranded	mm ²
flexible / Stranded wire with end ferrules	mm ²
Tightening torque range (clamping screw)	
Stripping length / Blade size	mm/-
Note	

Ordering data

Version	
	Medium yellow
Note	

Accessories

Screwable cross-connection	
	2-pole
	3-pole
	4-pole
End plate / Partition plate	
	dark brown
	Tropical applications
	dark brown
	Tropical applications
Cover / warning label	
	Cover / warning label

Marking systems (see assortment in catalogue 7)
Marking tags
For detailed information on other accessories and applications, refer to the „Accessories“ section

SAKG 32 II

50 mm²



32 x 80 x 53	
192 / 70	
10...70	

IEC 60947-7-1		
IEC	UL	CSA
1000	600	600
150	200	170
50	AWG 6...3/0	AWG 1...2/0
	8 / 3	
	/ 5VA	
Rated connection		
6.0...12 Nm (M 8)		
Note		
Conductor connection with cable lugs according to DIN 46234 and DIN 46235, from 10 ... 70 mm ²		

Type	Qty.	Order No.
SAKG 32/35 II	10	0637320000

Type	current	Qty.	Order No.
QL 2 SAKG32+70	150 A	5	0194000000
QL 3 SAKG32+70	150 A	5	0441500000
QL 4 SAKG32+70	150 A	5	0441600000
Width			
EP 2 SAKG46/35 HP/DBR	2 mm	10	0180700000
EP 2 SAKG46/35 HP/TF/GE	2 mm	10	0180800000
TW SAKG46 HP/DBR/2	2 mm	10	0177100000
TW SAKG46 HP/TF/GE/2	2 mm	10	0179900000
AH 32 SAKG32	30 mm	5	0326760000

DEK 5/5

SAKG 32 II G

50 mm²



32 x 80 x 53	
192 / 70	
10...70	

IEC 60947-7-1		
IEC	UL	CSA
1000	600	600
150	200	170
50	AWG 6...3/0	AWG 1...2/0
	8 / 3	
	/ 5VA	
Rated connection		
6.0...12 Nm (M 8)		
Note		
Conductor connection with cable lugs according to DIN 46234 and DIN 46235, from 10 ... 70 mm ²		

Type	Qty.	Order No.
SAKG 32/35 II/GW	10	0637420000

Type	current	Qty.	Order No.
QL 2 SAKG32+70	150 A	5	0194000000
QL 3 SAKG32+70	150 A	5	0441500000
QL 4 SAKG32+70	150 A	5	0441600000
Width			
EP 1 SAKG32/35 HP/DBR	2 mm	10	0180500000
EP 1 SAKG32/35 HP/TF/GE	2 mm	10	0180600000
TW SAKG28 HP/DBR/2	2 mm	10	0151400000
TW SAKG28 HP/TF/GE/2	2 mm	10	0164600000
AH 32 SAKG32	30 mm	5	0326760000

DEK 5/5

Special terminals - SAKG

TS 35 / KrG

In hazardous area applications, the installation instructions and the rated data specifications for accessories given in the technical appendix must be followed.

Width/Length/height with TS35x7.5	mm
max. current / max. cond. cross-section	A/mm ²
Max. clamping range	mm ²

Technical data

Rated data

Rated voltage	V
Rated current	A
Rated cross-section	mm ²
Rated impulse voltage / Pollution severity	kV/-
Gauge to IEC 60947-1 / UL94 Flammability class	
Approvals	

Clamped conductors (H05V/H07V)

solid / stranded	mm ²
flexible / Stranded wire with end ferrules	mm ²
Tightening torque range (clamping screw)	
Stripping length / Blade size	mm/-

Note

Ordering data

Version

Medium yellow

Note

Accessories

Screwable cross-connection



2-pole
3-pole
4-pole

End plate / Partition plate

dark brown
Tropical applications
dark brown
Tropical applications

Cover / warning label

Cover / warning label

SAKG 32 III

50 mm²

32 x 94 x 84.5

192 / 70

10...70



IEC 60947-7-1

IEC	UL	CSA
1000	600	600
150	165	185
50	AWG 6...3/0	AWG 1...2/0
8 / 3		
B11 / 5VA		

Rated connection

10...16 / 10...70
10...70 / 10...70
6.0...12 Nm (M 8)
26 /

A tightening torque of 12 Nm must be applied to 50 - 70 mm² stranded and AWG 2 - 3/0 7-core connections.

Type	Qty.	Order No.
SAKG 32/35 III	10	0637220000

Type	Qty.	Order No.
Width		
EP 2 SAKG46/35 HP/DBR	2 mm	10 0180700000
EP 2 SAKG46/35 HP/TF/GE	2 mm	10 0180800000
TW SAKG46 HP/DBR/2	2 mm	10 0177100000
TW SAKG46 HP/TF/GE/2	2 mm	10 0179900000
AH 32 SAKG32	30 mm	5 0326760000

Marking systems (see assortment in catalogue 7)

Marking tags

For detailed information on other accessories and applications, refer to the „Accessories“ section

DEK 5/5

SAKG 70 II G

70 mm²

32 x 84 x 51.4

192 / 95

10...95



IEC 60947-7-1

IEC	UL	CSA
1000		600
192		200
70	AWG 6...3/0	AWG 2/0...4/0
8 / 3		
/ 5VA		

Rated connection

10...16
6.0...12 Nm (M 8)

Conductor connection with cable lugs according to DIN 46234 with 16..95 mm² and DIN 46235 with 10 .. 50 mm²

Type	Qty.	Order No.
SAKG 70/35 II/GW	10	0636620000

Type	current	Qty.	Order No.
QL 2 SAKG32+70	150 A	5	0194000000
QL 3 SAKG32+70	150 A	5	0441500000
QL 4 SAKG32+70	150 A	5	0441600000
Width			
EP 1 SAKG32/35 HP/DBR	2 mm	10	0180500000
EP 1 SAKG32/35 HP/TF/GE	2 mm	10	0180600000
TW SAKG28 HP/DBR/2	2 mm	10	0151400000
TW SAKG28 HP/TF/GE/2	2 mm	10	0164600000
AH 32 SAKG32	30 mm	5	0326760000

DEK 5/5

SAKG 40 I

95 mm²



40 x 94 x 84.5

232 / 95
10...95

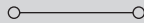

IEC 60947-7-1

IEC	UL	CSA
1000	600	600
232	195	250
95	AWG 2/0...4/0	AWG 2/0...4/0
8 / 3		
B12 / 5VA		



Rated connection

10...16 / 10...95
10...95 / 10...95
10...20 Nm (M 10)
25 /

Conductor connection with cable lugs acc. to DIN 46234 from 10 .. 95 mm²

Type	Qty.	Order No.
SAKG 40/35 I	5	0637520000

Type	current	Qty.	Order No.
QL 2 SAKG40/35	232 A	5	0211400000
QL 3 SAKG40/35	232 A	5	0444900000
QL 4 SAKG40/35	232 A	5	0445000000
Width			
EP 2 SAKG46/35 HP/DBR	2 mm	10	0180700000
EP 2 SAKG46/35 HP/TF/GE	2 mm	10	0180800000
TW SAKG46 HP/DBR/2	2 mm	10	0177100000
TW SAKG46 HP/TF/GE/2	2 mm	10	0179900000
AH 40 SAKG40	38 mm	5	0326860000

DEK 5/5

SAKG 40 II

95 mm²



40 x 90 x 53

232 / 95
10...95



IEC 60947-7-1

IEC	UL	CSA
1000	600	600
232	230	250
95	AWG 1...4/0	AWG 2/0...4/0
8 / 3		
/ 5VA		



Rated connection

...16
10...20 Nm (M 10)

Conductor connection with cable lugs according to DIN 46234, from 10 .. 95 mm²

Type	Qty.	Order No.
SAKG 40/35 II	5	0637720000

Type	current	Qty.	Order No.
QL 2 SAKG40/35	232 A	5	0211400000
QL 3 SAKG40/35	232 A	5	0444900000
QL 4 SAKG40/35	232 A	5	0445000000
Width			
EP 2 SAKG46/35 HP/DBR	2 mm	10	0180700000
EP 2 SAKG46/35 HP/TF/GE	2 mm	10	0180800000
TW SAKG46 HP/DBR/2	2 mm	10	0177100000
TW SAKG46 HP/TF/GE/2	2 mm	10	0179900000
AH 40 SAKG40	38 mm	5	0326860000

DEK 5/5

SAKG 40 II GW

95 mm²



40 x 90 x 53

232 / 95
10...95



IEC 60947-7-1

IEC	UL	CSA
1000	600	600
232	230	250
95	AWG 1...4/0	AWG 2/0...4/0
8 / 3		
/ 5VA		



Rated connection

...16
10...20 Nm (M 10)

Conductor connection with cable lugs according to DIN 46234, from 10 .. 95 mm²

Type	Qty.	Order No.
SAKG 40/35 II/GW	5	0637820000

Type	current	Qty.	Order No.
QL 2 SAKG40/35	232 A	5	0211400000
QL 3 SAKG40/35	232 A	5	0444900000
QL 4 SAKG40/35	232 A	5	0445000000
Width			
EP 2 SAKG46/35 HP/DBR	2 mm	10	0180700000
EP 2 SAKG46/35 HP/TF/GE	2 mm	10	0180800000
TW SAKG46 HP/DBR/2	2 mm	10	0177100000
TW SAKG46 HP/TF/GE/2	2 mm	10	0179900000
AH 40 SAKG40	38 mm	5	0326860000

DEK 5/5

Special terminals - SAKG

TS 35 / KrG

In hazardous area applications, the installation instructions and the rated data specifications for accessories given in the technical appendix must be followed.

Width/Length/height with TS35x7.5	mm
max. current / max. cond. cross-section	A/mm ²
Max. clamping range	mm ²

Technical data

Rated data

Rated voltage	V
Rated current	A
Rated cross-section	mm ²
Rated impulse voltage / Pollution severity	kV/-
Gauge to IEC 60947-1 / UL94 Flammability class	
Approvals	

Clamped conductors (H05V/H07V)

solid / stranded	mm ²
flexible / Stranded wire with end ferrules	mm ²
Tightening torque range (clamping screw)	
Stripping length / Blade size	mm/-

Note

Ordering data

Version

Medium yellow

Note

Accessories

Screwable cross-connection



2-pole
3-pole
4-pole

End plate / Partition plate

dark brown
Tropical applications
dark brown
Tropical applications

Cover / warning label

Cover / warning label

SAKG 40 III

95 mm²

40 x 98 x 84.5

232 / 95

10...95



IEC 60947-7-1

IEC	UL	CSA
1000	600	600
232	195	230
95	AWG 1...4/0	AWG 2/0...4/0
8 / 3		
B12 / 5VA		

Rated connection

10...16 / 10...95
10...95 / 10...95
16...20 Nm (M 10)
25 /

SAKG 46 II

150 mm²

46 x 106 x 57

353 / 185

10...185



IEC 60947-7-1

IEC	UL	CSA
1000	600	600
309	285	365
150	AWG 4/0...300	AWG 4...300
8 / 3		
/ 5VA		

Rated connection

10...16
14...31 Nm M 12

Conductor connection with cable lugs according to DIN 46234, from 10 ... 185 mm² and DIN 46235, from 25 ... 150 mm²

Type	Qty.	Order No.
SAKG 40/35 III	5	0637620000

Type	Qty.	Order No.
SAKG 46/35 II	5	0637920000

Type	Qty.	Order No.

Type	current	Qty.	Order No.
QL 2 SAKG46	309 A	5	0247000000
QL 3 SAKG46	309 A	5	0444400000
QL 4 SAKG46	309 A	5	0444500000

Width			
EP 2 SAKG46/35 HP/DBR	2 mm	10	0180700000
EP 2 SAKG46/35 HP/TF/GE	2 mm	10	0180800000
TW SAKG46 HP/DBR/2	2 mm	10	0177100000
TW SAKG46 HP/TF/GE/2	2 mm	10	0179900000

Width			
EP 2 SAKG46/35 HP/DBR	2 mm	10	0180700000
EP 2 SAKG46/35 HP/TF/GE	2 mm	10	0180800000
TW SAKG46 HP/DBR/2	2 mm	10	0177100000
TW SAKG46 HP/TF/GE/2	2 mm	10	0179900000

AH 40 SAKG40	38 mm	5	0326860000
--------------	-------	---	------------

AH 46 SAKG46	46 mm	5	0326960000
--------------	-------	---	------------

Marking systems (see assortment in catalogue 7)

Marking tags

For detailed information on other accessories and applications, refer to the „Accessories“ section

DEK 5/5

DEK 5/5

SAKG 46 II GW

150 mm²



46 x 106 x 57
353 / 185
 10...185



IEC 60947-7-1

IEC	UL	CSA
1000	600	600
309	285	365
150	AWG 4/0...kcmil 300	AWG 1...300
8 / 3		
/ 5VA		



Rated connection

10...16

14...31 Nm M 12

Conductor connection with cable lugs according to DIN 46234, from 10 .. 185 mm² and DIN 46235, from 25 .. 150 mm²

Type	Qty.	Order No.
SAKG 46/35 II/GW	5	0638020000

Type	current	Qty.	Order No.
QL 2 SAKG46	309 A	5	0247000000
QL 3 SAKG46	309 A	5	0444400000
QL 4 SAKG46	309 A	5	0444500000
Width			
EP 2 SAKG46/35 HP/DBR	2 mm	10	0180700000
EP 2 SAKG46/35 HP/TF/GE	2 mm	10	0180800000
TW SAKG46 HP/DBR/2	2 mm	10	0177100000
TW SAKG46 HP/TF/GE/2	2 mm	10	0179900000
AH 46 SAKG46	46 mm	5	0326960000

DEK 5/5

SAKG 54 II

240 mm²

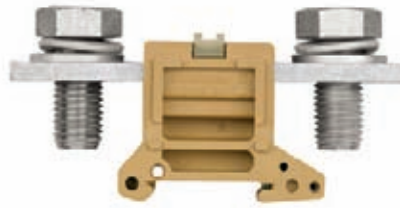

54 x 122 x 60.5
415 / 240
 10...240



IEC 60947-7-1

IEC	UL	CSA
1000	600	600
415	380	600
240	kcmil 300...kcmil 500	kcmil 300...kcmil 500
8 / 3		
/ 5VA		



Rated connection

25...60 Nm M 16

Conductor connection with cable lugs according to DIN 46234 and DIN 46235, from 70 .. 240 mm²

Type	Qty.	Order No.
SAKG 54/35 II	5	0638120000

Type	current	Qty.	Order No.
QL 2 SAKG54	415 A	5	0264400000
QL 3 SAKG54	415 A	5	0408000000
QL 4 SAKG54	415 A	5	0247400000
Width			
EP 2 SAKG46/35 HP/DBR	2 mm	10	0180700000
EP 2 SAKG46/35 HP/TF/GE	2 mm	10	0180800000
TW SAKG46 HP/DBR/2	2 mm	10	0177100000
TW SAKG46 HP/TF/GE/2	2 mm	10	0179900000

DEK 5/5

SAKG 54 II GW

240 mm²



54 x 122 x 60.5
415 / 240
 10...240

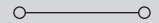

IEC 60947-7-1

IEC	UL	CSA
1000	600	600
415	380	600
240	kcmil 300...kcmil 500	kcmil 300...kcmil 500
8 / 3		
/ 5VA		



Rated connection

25...60 Nm M 16

Conductor connection with cable lugs according to DIN 46234 and DIN 46235, from 70 .. 240 mm²

Type	Qty.	Order No.
SAKG 54/35 II/GW	5	0638220000

Type	current	Qty.	Order No.
QL 2 SAKG54	415 A	5	0264400000
QL 3 SAKG54	415 A	5	0408000000
QL 4 SAKG54	415 A	5	0247400000
Width			
EP 2 SAKG46/35 HP/DBR	2 mm	10	0180700000
EP 2 SAKG46/35 HP/TF/GE	2 mm	10	0180800000
TW SAKG46 HP/DBR/2	2 mm	10	0177100000
TW SAKG46 HP/TF/GE/2	2 mm	10	0179900000

DEK 5/5

Stud Terminal - KST

TS 35 / PA

In hazardous area applications, the installation instructions and the rated data specifications for accessories given in the technical appendix must be followed.

Width/Length/height with TS35x7.5 mm
 max. current / max. cond. cross-section A/mm²
 Max. clamping range mm²

Technical data

Rated data

Rated voltage	V
Rated current	A
Rated cross-section	mm ²
Rated impulse voltage / Pollution severity	kV/-
Gauge to IEC 60947-1 / UL94 Flammability class	
Approvals	

Tightening torque range (clamping screw)

Note

Ordering data

Version

TS 35 x 7,5
 TS 35 x 15/2,3

Note

Accessories

Screwable cross-connection

2-pole

Partition plate

left
 right

KST 5/35

10 mm²

24 x 62.5 x 49.5

57 /



IEC	UL	CSA
1000	600	600
57	50	65
10	AWG 12...6	AWG 8...2
8 / 3		
/ V2		



Rated connection

2.0...4.0 Nm

KST 6/35

16 mm²

24 x 60 x 54.5

76 /

...



IEC	UL	CSA
1000	600	600
76	65	80
16	AWG 12...6	AWG 12...6
8 / 3		
/ V2		



Rated connection

3.0...6.0 Nm

Type	Qty.	Order No.
KST 5/35 M5X18	25	9528300000

Type	Qty.	Order No.
KST 6/35 M6X22	25	9506940000

Type	Qty.	Order No.
Width		
TW KST5-12 LI/NO 160/HM	10	1752800000
TW KST5-12 RE/NO 160/HM	10	1718530000

Type	current	Qty.	Order No.
QL 2 KST6	76 A	5	9501350000
Width			
TW KST5-12 LI/NO 160/HM		10	1752800000
TW KST5-12 RE/NO 160/HM		10	1718530000

Marking systems (see assortment in catalogue 7)

Marking tags

For detailed information on other accessories and applications, refer to the „Accessories“ section

DEK 5/5

DEK 5/5

KST 8/35

35 mm²



24 x 62.5 x 72

125 /

...

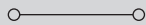

IEC	UL	CSA
1000	600	600
125	115	130
35	AWG 12...2	AWG 12...2
	8 / 3	
	/ V2	



Rated connection

6.0...12 Nm

Type	Qty.	Order No.
KST 8/35 M8X30	25	9506950000
KST 8/35 M8X30	25	9528320000

Type	current	Qty.	Order No.
QL 2 KST8	125 A	5	9501360000
	Width		
TW KST5-12 LI/NO 160/HM		10	1752800000
TW KST5-12 RE/NO 160/HM		10	1718530000

DEK 5/5

KST 10/35

70 mm²



34 x 60 x 82

192 /

...



IEC	UL	CSA
1000	600	600
232	175	200
70	AWG 12...2/0	AWG 12...2/0
	8 / 3	
	/ V2	



Rated connection

Type	Qty.	Order No.
KST 10/35 M10X39	20	9506960000
KST 10/35 M10X39	20	9528330000

Type	current	Qty.	Order No.
QL 2 KST10		5	9501370000
	Width		
TW KST5-12 LI/NO 160/HM		10	1752800000
TW KST5-12 RE/NO 160/HM		10	1718530000

DEK 5/5

KST 12/35

95 mm²



34 x 60 x 74.5

232 /

...

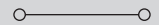

IEC	UL	CSA
1000	600	600
232	200	250
95	AWG 12...3	...0000
	8 / 3	
	/ V2	



Rated connection

14...31 Nm

Type	Qty.	Order No.
KST 12/35 M12X37	20	9506970000
KST 12/35 M12X37	20	9528340000

Type	current	Qty.	Order No.
QL 2 KST12	232 A	5	9501380000
	Width		
TW KST5-12 LI/NO 160/HM		10	1752800000
TW KST5-12 RE/NO 160/HM		10	1718530000

DEK 5/5

Terminals with electronic components

With electronic components
TS 35 / PA

In hazardous area applications, the installation instructions and the rated data specifications for accessories given in the technical appendix must be followed.

Width/Length/height with TS35x7.5	mm
max. current / max. cond. cross-section	A/mm ²
Max. clamping range	mm ²

Technical data

Rated data	
Rated voltage	V
Rated current	A
Rated cross-section	mm ²
Rated impulse voltage / Pollution severity	kV/-
Gauge to IEC 60947-1 / UL94 Flammability class	
Approvals	
Electronic fixtures	
Diode reverse voltage / Diode current	-
Operating voltage for display, min. / Current	V/mA
Clamped conductors (H05V/H07V)	
solid / stranded	mm ²
flexible / Stranded wire with end ferrules	mm ²
Tightening torque range (clamping screw)	
Stripping length / Blade size	mm/-
Note	

Ordering data

Version	
	Red LED
	Green LED
	Neon lamp
Note	

Accessories

Screwable cross-connection	
	2-pole
	3-pole
	4-pole
	10-pole
External cross-connection	
	2-pole
	3-pole
	4-pole
Switchable link	
	Switchable link
	Connecting sleeve
	Mounting screw
Testing / Checking	
	Test plug
	Socket
End plate / Partition plate	
	beige
Small partition	
	Small partition

Marking systems (see assortment in catalogue 7)
Marking tags

For detailed information on other accessories and applications, refer to the „Accessories“ section

DK 4 LD/1

4 mm²

DC voltage indicator



6 x 50 x 52.5
10 / 4
0.5...4

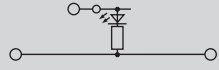

IEC 60947-7-1

IEC	UL	CSA
24		
10		
4		
	1 / 3	
	A3 / V2	
		
24 / 5		
Rated connection		
0.5...4 / 0.5...4		
0.5...4 / 0.5...4		
0.5...1.0 Nm (M 3)		
9 / 0.6 x 3.5 mm		
Note		

Type	Qty.	Order No.
DK 4/35 LD GR 24VDC	25	0395460000
Note		

Type	current	Qty.	Order No.
Q 2 AKZ4	32 A	50	0336400000
Q 3 AKZ4	32 A	50	0336500000
Q 4 AKZ4	32 A	50	0336600000
External cross-connection			
QB 2 WI RA6 IS	27 A	50	0482700000
QB 3 WI RA6 IS	27 A	50	0482800000
QB 4 WI RA6 IS	27 A	50	0482900000
Switchable link			
VL 2 AKZ4/DK4		50	0446700000
VH 10/4/2.8 AKZ4		50	0446600000
BFSC M2.5X14 SAKD2.5N		100	0266800000
Testing / Checking			
PS 2.3 RT	5.4 mm	20	0180400000
STB 8.5/D4/2.3/M2.5 AKZ		50	0215700000
End plate / Partition plate			
AP DK4	1.5 mm	20	0359260000
Small partition			
TSCH 4 AKZ4	6 mm	100	0363360000
Note			

DEK 5/6

DK 4 LD/2

4 mm²

DC voltage indicator



6 x 50 x 52.5
10 / 4
0.5...4

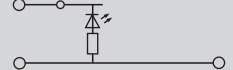

IEC 60947-7-1

IEC	UL	CSA
24		
10		
4		
	1 / 3	
	A3 / V2	
		
24 / 5		
Rated connection		
0.5...4 / 0.5...4		
0.5...4 / 0.5...4		
0.5...1.0 Nm (M 3)		
9 / 0.6 x 3.5 mm		
Note		

Type	Qty.	Order No.
DK 4/35 LD GR 24VDC	25	0395760000
Note		

Type	current	Qty.	Order No.
Q 2 AKZ4	32 A	50	0336400000
Q 3 AKZ4	32 A	50	0336500000
Q 4 AKZ4	32 A	50	0336600000
External cross-connection			
QB 2 WI RA6 IS	27 A	50	0482700000
QB 3 WI RA6 IS	27 A	50	0482800000
QB 4 WI RA6 IS	27 A	50	0482900000
Switchable link			
VL 2 AKZ4/DK4		50	0446700000
VH 10/4/2.8 AKZ4		50	0446600000
BFSC M2.5X14 SAKD2.5N		100	0266800000
Testing / Checking			
PS 2.3 RT	5.4 mm	20	0180400000
STB 8.5/D4/2.3/M2.5 AKZ		50	0215700000
End plate / Partition plate			
AP DK4	1.5 mm	20	0359260000
Small partition			
TSCH 4 AKZ4	6 mm	100	0363360000
Note			

DEK 5/6

DK 4 LD/3

4 mm²

DC voltage indicator



6 x 50 x 52.5
10 / 4
0.5...4

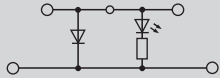

IEC 60947-7-1

IEC	UL	CSA
24		
10		
4		
	1 / 3	
	A3 / V2	



24 / 5

Rated connection

0.5...4 / 0.5...4
0.5...4 / 0.5...4
0.5...1.0 Nm (M 3)
9 / 0.6 x 3.5 mm

Type	Qty.	Order No.
DK 4/35 LD ROT 24VDC	25	0210260000
DK 4/35 LD GR 24VDC	25	0210460000

Type	current	Qty.	Order No.
Q 2 AKZ4	32 A	50	0336400000
Q 3 AKZ4	32 A	50	0336500000
Q 4 AKZ4	32 A	50	0336600000
Width			
QB 2 WI RA6 IS	27 A	50	0482700000
QB 3 WI RA6 IS	27 A	50	0482800000
QB 4 WI RA6 IS	27 A	50	0482900000
VL 2 AKZ4/DK4	32 A	50	0446700000
VH 10/4/2.8 AKZ4	50		0446600000
BFSC M2.5X14 SAKD2.5N	100		0266800000
Width			
PS 2.3 RT	5.4 mm	20	0180400000
STB 8.5/D4/2.3/M2.5 AKZ	50		0215700000
AP DK4	1.5 mm	20	0359260000
TSCH 4 AKZ4	6 mm	100	0363360000

DEK 5/6

DK 4 LD/4

4 mm²

DC voltage indicator

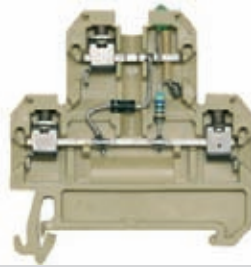

6 x 50 x 52.5
10 / 4
0.5...4

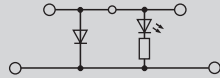

IEC 60947-7-1

IEC	UL	CSA
24		
10		
4		
	1 / 3	
	A3 / V2	



24 / 5

Rated connection

0.5...4 / 0.5...4
0.5...4 / 0.5...4
0.5...1.0 Nm (M 3)
9 / 0.6 x 3.5 mm

Type	Qty.	Order No.
DK 4/35 LD GR 24VDC	25	0210060000

Type	current	Qty.	Order No.
Q 2 AKZ4	32 A	50	0336400000
Q 3 AKZ4	32 A	50	0336500000
Q 4 AKZ4	32 A	50	0336600000
Width			
QB 2 WI RA6 IS	27 A	50	0482700000
QB 3 WI RA6 IS	27 A	50	0482800000
QB 4 WI RA6 IS	27 A	50	0482900000
VL 2 AKZ4/DK4	32 A	50	0446700000
VH 10/4/2.8 AKZ4	50		0446600000
BFSC M2.5X14 SAKD2.5N	100		0266800000
Width			
PS 2.3 RT	5.4 mm	20	0180400000
STB 8.5/D4/2.3/M2.5 AKZ	50		0215700000
AP DK4	1.5 mm	20	0359260000
TSCH 4 AKZ4	6 mm	100	0363360000

DEK 5/6

DK 4 LD/5

4 mm²

AC voltage indicator

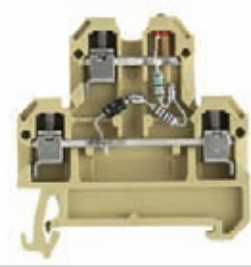

6 x 50 x 52.5
10 / 4
0.5...4

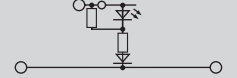

IEC 60947-7-1

IEC	UL	CSA
24		
10		
4		
	1 / 3	
	A3 / V2	



24 / 5

Rated connection

0.5...4 / 0.5...4
0.5...4 / 0.5...4
0.5...1.0 Nm (M 3)
9 / 0.6 x 3.5 mm

Type	Qty.	Order No.
DK 4/35 LD 1D ROT 24VAC	25	0395960000

Type	current	Qty.	Order No.
Q 2 AKZ4	32 A	50	0336400000
Q 3 AKZ4	32 A	50	0336500000
Q 4 AKZ4	32 A	50	0336600000
Width			
QB 2 WI RA6 IS	27 A	50	0482700000
QB 3 WI RA6 IS	27 A	50	0482800000
QB 4 WI RA6 IS	27 A	50	0482900000
VL 2 AKZ4/DK4	32 A	50	0446700000
VH 10/4/2.8 AKZ4	50		0446600000
BFSC M2.5X14 SAKD2.5N	100		0266800000
Width			
PS 2.3 RT	5.4 mm	20	0180400000
STB 8.5/D4/2.3/M2.5 AKZ	50		0215700000
AP DK4	1.5 mm	20	0359260000
TSCH 4 AKZ4	6 mm	100	0363360000

DEK 5/6

Terminals with electronic components

With electronic components
TS 35 / PA

DK 4 GL I

4 mm²

Current indicator

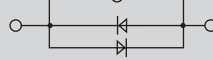
6 x 50 x 52.5
/ 4
0.33...4

In hazardous area applications, the installation instructions and the rated data specifications for accessories given in the technical appendix must be followed.

Width/Length/height with TS35x7.5 mm
max. current / max. cond. cross-section A/mm²
Max. clamping range mm²

Technical data

Rated data	
Rated voltage	V
Rated current	A
Rated cross-section	mm ²
Rated impulse voltage / Pollution severity	kV/-
Gauge to IEC 60947-1 / UL94 Flammability class	
Approvals	
Electronic fixtures	
Diode reverse voltage / Diode current	-
Operating voltage for display, min. / Current	V/A
Clamped conductors (H05V/H07V)	
solid / stranded	mm ²
flexible / Stranded wire with end ferrules	mm ²
Tightening torque range (clamping screw)	
Stripping length / Blade size	mm/-
Note	

IEC	UL	CSA
250		
10		
4		
	1 / 3	
	A3 / V2	
3 / 1		
Rated connection		
0.5...4 / 0.5...4		
0.5...4 / 0.5...4		
0.5...1.0 Nm (M 3)		
9 / 0.6 x 3.5 mm		
Note		

Ordering data

Version	
Red LED	
Green LED	
Neon lamp	
Note	

Type	Qty.	Order No.
DK 4/35 GL 1D 11,0A	25	1111160000
Note		

Accessories

Screwable cross-connection	
	2-pole
	3-pole
	4-pole
	10-pole
External cross-connection	
	2-pole
	3-pole
	4-pole
Switchable link	
	Switchable link
	Connecting sleeve
	Mounting screw
Testing / Checking	
	Test plug
	Socket
End plate / Partition plate	
	beige
Small partition	
	Small partition

Type	current	Qty.	Order No.
Q 2 AKZ4	32 A	50	0336400000
Q 3 AKZ4	32 A	50	0336500000
Q 4 AKZ4	32 A	50	0336600000
Q 10 AKZ4	32 A	20	0368600000
Width			
QB 2 WI RA6 IS	27 A	50	0482700000
QB 3 WI RA6 IS	27 A	50	0482800000
QB 4 WI RA6 IS	27 A	50	0482900000
VL 2 AKZ4/DK4	32 A	50	0446700000
VH 10/4/2.8 AKZ4		50	0446600000
BFSC M2.5X14 SAKD2.5N		100	0266800000
Width			
PS 2.3 RT	5.4 mm	20	0180400000
STB 8.5/D4/2.3/M2.5 AKZ		50	0215700000
AP DK4	1.5 mm	20	0359260000
TSCH 4 AKZ4	6 mm	100	0363360000
Note			

Marking systems (see assortment in catalogue 7)
Marking tags

For detailed information on other accessories and applications, refer to the „Accessories“ section

DEK 5/6

With electronic components TS 35 / PA

In hazardous area applications, the installation instructions and the rated data specifications for accessories given in the technical appendix must be followed.

Width/Length/height with TS35x7.5	mm
max. current / max. cond. cross-section	A/mm ²
Max. clamping range	mm ²

Technical data

Rated data	
Rated voltage	V
Rated current	A
Rated cross-section	mm ²
Rated impulse voltage / Pollution severity	kV/-
Gauge to IEC 60947-1 / UL94 Flammability class	
Approvals	
Electronic fixtures	
Diode reverse voltage / Diode current	A
Operating voltage for display, min. / Current	-/A
Clamped conductors (H05V/H07V)	
solid / stranded	mm ²
flexible / Stranded wire with end ferrules	mm ²
Tightening torque range (clamping screw)	
Stripping length / Blade size	mm/-
Note	

Ordering data

Version	
	Red LED
	Green LED
Note	

Accessories

Screwable cross-connection	
	2-pole
	3-pole
	4-pole
External cross-connection	
	2-pole
	3-pole
	4-pole
Switchable link	
	Switchable link
	Connecting sleeve
	Mounting screw
Testing / Checking	
	Test plug
	Socket
End plate / Partition plate	
	beige
Small partition	
	Small partition
Marking systems	
	(see assortment in catalogue 7)
	Marking tags
For detailed information on other accessories and applications, refer to the „Accessories“ section	

DK 4 D/1

4 mm²

Diode terminal, e.g. as reverse polarity protection



6 x 50 x 52.5	
10 / 4	
0.33...4	

IEC	UL	CSA
380		300
10		10
4		AWG 22...12
		/ 3
		A3 / V2
		
1000 / 1		
Rated connection		
0.5...4 / 0.5...4		
0.5...4 / 0.5...4		
0.5...0.8 Nm (M 3)		
9 / 0.6 x 3.5 mm		
Diode current: max 1A. (1 N 4007)		

Type	Qty.	Order No.
DK 4/35 1D GET.SCH.	25	0396360000

Type	current	Qty.	Order No.
Q 2 AKZ4	32 A	50	0336400000
Q 3 AKZ4	32 A	50	0336500000
Q 4 AKZ4	32 A	50	0336600000
QB 2 WI RA6 IS	27 A	50	0482700000
QB 3 WI RA6 IS	27 A	50	0482800000
QB 4 WI RA6 IS	27 A	50	0482900000
VL 2 AKZ4/DK4	32 A	50	0446700000
VH 10/4/2.8 AKZ4		50	0446600000
BFSC M2.5X14 SAKD2.5N		100	0266800000
		Width	
PS 2.3 RT	5.4 mm	20	0180400000
STB 8.5/D4/2.3/M2.5 AKZ		50	0215700000
AP DK4	1.5 mm	20	0359260000
TSCH 4 AKZ4	6 mm	100	0363360000

DEK 5/6

Terminals with electronic components

DK 4 D/2

4 mm²

Suppressor circuit for contactor and solenoid valve (DC voltage)



6 x 50 x 52.5	
10 / 4	
0.33...4	

IEC	UL	CSA
380		300
10		10
4		AWG 22...12
		/ 3
		A3 / V2
		
1000 / 1		
Rated connection		
0.5...4 / 0.5...4		
0.5...4 / 0.5...4		
0.5...0.8 Nm (M 3)		
9 / 0.6 x 3.5 mm		
Diode current: max 1A. (1 N 4007)		

Type	Qty.	Order No.
DK 4/35 1D A1	25	0538960000
DK 4/35 1D A1 BL	25	0538980000

Type	current	Qty.	Order No.
Q 2 AKZ4	32 A	50	0336400000
Q 3 AKZ4	32 A	50	0336500000
Q 4 AKZ4	32 A	50	0336600000
QB 2 WI RA6 IS	27 A	50	0482700000
QB 3 WI RA6 IS	27 A	50	0482800000
QB 4 WI RA6 IS	27 A	50	0482900000
VL 2 AKZ4/DK4		50	0446700000
VH 10/4/2.8 AKZ4		50	0446600000
BFSC M2.5X14 SAKD2.5N		100	0266800000
		Width	
PS 2.3 RT	5.4 mm	20	0180400000
STB 8.5/D4/2.3/M2.5 AKZ		50	0215700000
AP DK4	1.5 mm	20	0359260000
TSCH 4 AKZ4	6 mm	100	0363360000

DEK 5/6

Terminals with electronic components

With electronic components
TS 35 / PA

In hazardous area applications, the installation instructions and the rated data specifications for accessories given in the technical appendix must be followed.

Width/Length/height with TS35x7.5	mm
max. current / max. cond. cross-section	A/mm ²
Max. clamping range	mm ²

Technical data

Rated data	
Rated voltage	V
Rated current	A
Rated cross-section	mm ²
Rated impulse voltage / Pollution severity	kV/-
Gauge to IEC 60947-1 / UL94 Flammability class	
Approvals	
Electronic fixtures	
Diode reverse voltage / Diode current	A
Operating voltage for display, min. / Current	-/A
Clamped conductors (H05V/H07V)	
solid / stranded	mm ²
flexible / Stranded wire with end ferrules	mm ²
Tightening torque range (clamping screw)	
Stripping length / Blade size	mm/-
Note	

Ordering data

Version	
	Red LED
	Green LED
Note	

Accessories

Screwable cross-connection	
	2-pole
	3-pole
	4-pole
External cross-connection	
	2-pole
	3-pole
	4-pole
Switchable link	
	Switchable link
	Connecting sleeve
	Mounting screw
Testing / Checking	
	Test plug
	Socket
End plate / Partition plate	
	beige
Small partition	
	Small partition

Marking systems (see assortment in catalogue 7)
Marking tags

For detailed information on other accessories and applications, refer to the „Accessories“ section

DK 4 D/3

4 mm²

Suppressor circuit for contactor and solenoid valve (DC voltage)



6 x 50 x 52.5
10 / 4
0.33...4

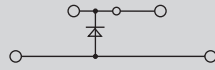

IEC	UL	CSA
380		300
10		10
4		
	/ 3	
	A3 / V2	
		
1000 / 1		
Rated connection		
0.5...4 / 0.5...4		
0.5...4 / 0.5...4		
0.5...0.8 Nm (M 3)		
9 / 0.6 x 3.5 mm		
Diode current: max 1A. (1 N 4007)		

Type	Qty.	Order No.
DK 4/35 1D A2	25	0538860000
Note		

Type	current	Qty.	Order No.
Q 2 AKZ4	32 A	50	0336400000
Q 3 AKZ4	32 A	50	0336500000
Q 4 AKZ4	32 A	50	0336600000
External cross-connection			
QB 2 WI RA6 IS	27 A	50	0482700000
QB 3 WI RA6 IS	27 A	50	0482800000
QB 4 WI RA6 IS	27 A	50	0482900000
Switchable link			
VL 2 AKZ4/DK4		50	0446700000
VH 10/4/2.8 AKZ4		50	0446600000
BFSC M2.5X14 SAKD2.5N		100	0266800000
Testing / Checking			
PS 2.3 RT	5.4 mm	20	0180400000
STB 8.5/D4/2.3/M2.5 AKZ		50	0215700000
End plate / Partition plate			
AP DK4	1.5 mm	20	0359260000
Small partition			
TSCH 4 AKZ4	6 mm	100	0363360000

Marking systems (see assortment in catalogue 7)
DEK 5/6

For detailed information on other accessories and applications, refer to the „Accessories“ section

DK 4 D/4

4 mm²

Diode terminal for lamp test circuits



6 x 50 x 52.5
10 / 4
0.33...4

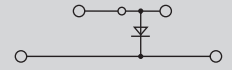

IEC	UL	CSA
380		300
10		10
4		
	/ 3	
	A3 / V2	
		
1000 / 1		
Rated connection		
0.5...4 / 0.5...4		
0.5...4 / 0.5...4		
0.5...0.8 Nm (M 3)		
9 / 0.6 x 3.5 mm		
Diode current: max 1A. (1 N 4007)		

Type	Qty.	Order No.
DK 4/35 2D GET.SCH. A1	25	0396600000
Note		

Type	current	Qty.	Order No.
Q 2 AKZ4	32 A	50	0336400000
Q 3 AKZ4	32 A	50	0336500000
Q 4 AKZ4	32 A	50	0336600000
External cross-connection			
QB 2 WI RA6 IS	27 A	50	0482700000
QB 3 WI RA6 IS	27 A	50	0482800000
QB 4 WI RA6 IS	27 A	50	0482900000
Switchable link			
VL 2 AKZ4/DK4	32 A	50	0446700000
VH 10/4/2.8 AKZ4		50	0446600000
BFSC M2.5X14 SAKD2.5N		100	0266800000
Testing / Checking			
PS 2.3 RT	5.4 mm	20	0180400000
STB 8.5/D4/2.3/M2.5 AKZ		50	0215700000
End plate / Partition plate			
AP DK4	1.5 mm	20	0359260000
Small partition			
TSCH 4 AKZ4	6 mm	100	0363360000

Marking systems (see assortment in catalogue 7)
DEK 5/6

For detailed information on other accessories and applications, refer to the „Accessories“ section

DK 4 D/5

4 mm²

Diode terminal for lamp test circuits

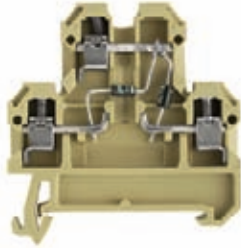

6 x 50 x 52.5
10 / 4
0.33...4

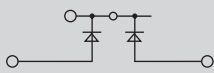

IEC	UL	CSA
380		300
10		10
4		
	/ 3	
	A3 / V2	
1000 / 1		
Rated connection		
0.5...4 / 0.5...4		
0.5...4 / 0.5...4		
0.5...0.8 Nm (M 3)		
9 / 0.6 x 3.5 mm		
Diode current: max 1A. (1 N 4007)		

Type	Qty.	Order No.
DK 4/35 2D GET.SCH. A2	25	0396860000

Type	current	Qty.	Order No.
Q 2 AKZ4	32 A	50	0336400000
Q 3 AKZ4	32 A	50	0336500000
Q 4 AKZ4	32 A	50	0336600000
QB 2 WI RA6 IS	27 A	50	0482700000
QB 3 WI RA6 IS	27 A	50	0482800000
QB 4 WI RA6 IS	27 A	50	0482900000
VL 2 AKZ4/DK4	32 A	50	0446700000
VH 10/4/2.8 AKZ4		50	0446600000
BFSC M2.5X14 SAKD2.5N		100	0266800000
Width			
PS 2.3 RT	5.4 mm	20	0180400000
STB 8.5/D4/2.3/M2.5 AKZ		50	0215700000
AP DK4	1.5 mm	20	0359260000
TSCH 4 AKZ4	6 mm	100	0363360000

DEK 5/6

DK 4 D/6

4 mm²

Diode terminal for lamp test circuits

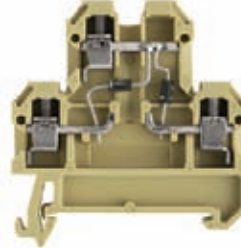

6 x 50 x 52.5
10 / 4
0.33...4

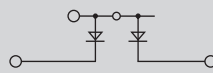

IEC	UL	CSA
380		300
10		10
4		
	/ 3	
	A3 / V2	
1000 / 1		
Rated connection		
0.5...4 / 0.5...4		
0.5...4 / 0.5...4		
0.5...0.8 Nm (M 3)		
9 / 0.6 x 3.5 mm		
Diode current: max 1A. (1 N 4007)		

Type	Qty.	Order No.
DK 4/35 2D GET.SCH. A1	25	0396760000

Type	current	Qty.	Order No.
Q 2 AKZ4	32 A	50	0336400000
Q 3 AKZ4	32 A	50	0336500000
Q 4 AKZ4	32 A	50	0336600000
QB 2 WI RA6 IS	27 A	50	0482700000
QB 3 WI RA6 IS	27 A	50	0482800000
QB 4 WI RA6 IS	27 A	50	0482900000
VL 2 AKZ4/DK4	32 A	50	0446700000
VH 10/4/2.8 AKZ4		50	0446600000
BFSC M2.5X14 SAKD2.5N		100	0266800000
Width			
PS 2.3 RT	5.4 mm	20	0180400000
STB 8.5/D4/2.3/M2.5 AKZ		50	0215700000
AP DK4	1.5 mm	20	0359260000
TSCH 4 AKZ4	6 mm	100	0363360000

DEK 5/6

DK 4 D/7

4 mm²

Diode terminal for lamp test circuits, with protective resistor

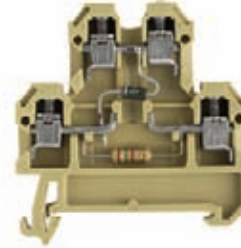

6 x 50 x 52.5
10 / 4
0.33...4

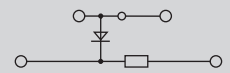

IEC	UL	CSA
24		300
10		10
4		
	/ 3	
	A3 / V2	
/ 1		
Rated connection		
0.5...4 / 0.5...4		
0.5...4 / 0.5...4		
0.5...0.8 Nm (M 3)		
9 / 0.6 x 3.5 mm		
Diode current: max 1A. (1 N 4007)		

Type	Qty.	Order No.
DK 4/35 1D 1K5 GET.SCH	25	0396960000

Type	current	Qty.	Order No.
Q 2 AKZ4	32 A	50	0336400000
Q 3 AKZ4	32 A	50	0336500000
Q 4 AKZ4	32 A	50	0336600000
QB 2 WI RA6 IS	27 A	50	0482700000
QB 3 WI RA6 IS	27 A	50	0482800000
QB 4 WI RA6 IS	27 A	50	0482900000
VL 2 AKZ4/DK4		50	0446700000
VH 10/4/2.8 AKZ4		50	0446600000
BFSC M2.5X14 SAKD2.5N		100	0266800000
Width			
PS 2.3 RT	5.4 mm	20	0180400000
STB 8.5/D4/2.3/M2.5 AKZ		50	0215700000
AP DK4	1.5 mm	20	0359260000
TSCH 4 AKZ4	6 mm	100	0363360000

DEK 5/6

Terminals with electronic components

With electronic components
TS 35 / PA

In hazardous area applications, the installation instructions and the rated data specifications for accessories given in the technical appendix must be followed.

Width/Length/height with TS35x7.5	mm
max. current / max. cond. cross-section	A/mm ²
Max. clamping range	mm ²

Technical data

Rated data	
Rated voltage	V
Rated current	A
Rated cross-section	mm ²
Rated impulse voltage / Pollution severity	kV/-
Gauge to IEC 60947-1 / UL94 Flammability class	
Approvals	
Electronic fixtures	
Diode reverse voltage / Diode current	-
Operating voltage for display, min. / Current	-/A
Clamped conductors (H05V/H07V)	
solid / stranded	mm ²
flexible / Stranded wire with end ferrules	mm ²
Tightening torque range (clamping screw)	
Stripping length / Blade size	mm/-
Note	

Ordering data

Version	
	Red LED
Note	

Accessories

Screwable cross-connection	
	2-pole
	3-pole
	4-pole
	10-pole
External cross-connection	
	2-pole
	3-pole
	4-pole
Switchable link	
Switchable link	
Connecting sleeve	
Mounting screw	
Testing / Checking	
Test plug	
Socket	
End plate / Partition plate	
	beige
End bracket	
	Dark beige Wemid

Marking systems (see assortment in catalogue 7)
Marking tags

For detailed information on other accessories and applications, refer to the „Accessories“ section

DK 4 RC

4 mm²

Terminal with RC combination



18 x 50 x 52.5
/ 4
0.33...4

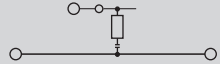

IEC	UL	CSA
230		
10		
4		
		/ 3
		A3 / V2
Rated connection		
0.5...4 / 0.5...4		
0.5...4 / 0.5...4		
0.5...0.8 Nm (M 3)		
9 / 0.6 x 3.5 mm		
Note		

Type	Qty.	Order No.
DK 4/35 RC 220R/220N	5	0053160000
Note		

Type	current	Qty.	Order No.
Q 2 AKZ4	32 A	50	0336400000
Q 3 AKZ4	32 A	50	0336500000
Q 4 AKZ4	32 A	50	0336600000
Q 10 AKZ4	32 A	20	0368600000
Width			
PS 2.3 RT	5.4 mm	20	0180400000
STB 8.5/D4/2.3/M2.5 AKZ		50	0215700000
Width			
AP DK4	1.5 mm	20	0359260000
EW 35	8.5 mm	50	0383560000
Note			

DEK 6
End plate
AP DK4: 0359260000

DK 4 PT 100

4 mm²

Diode terminal for central control and communication system



6 x 65 x 53.5
10 / 4
0.33...4

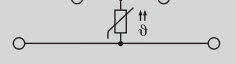

IEC	UL	CSA
400		
10		
4		
		/ 3
		A3 / V2
Rated connection		
0.5...4 / 0.5...4		
0.5...4 / 0.5...2.5		
0.4...0.7 Nm (M 2.5)		
6 / 0.6 x 3.5 mm		
Note		

Type	Qty.	Order No.
DKT 4/35 PT100	10	8014720000
Note		

Type	current	Qty.	Order No.
Q 2 AKZ4	32 A	50	0336400000
Q 3 AKZ4	32 A	50	0336500000
Q 4 AKZ4	32 A	50	0336600000
QB 2 WI RA6 IS	27 A	50	0482700000
QB 3 WI RA6 IS	27 A	50	0482800000
QB 4 WI RA6 IS	27 A	50	0482900000
Width			
PS 2.3 RT	5.4 mm	20	0180400000
STB 8.5/D4/2.3/M2.5 AKZ		50	0215700000
Width			
AP DKT4 PA	1.5 mm	20	0687560000
Note			

DEK 5/6

SAKT E/35

6 mm²

neon lamp



In hazardous area applications, the installation instructions and the rated data specifications for accessories given in the technical appendix must be followed.

Width/Length/height with TS35x7.5	mm
max. current / max. cond. cross-section	A/mm ²
Max. clamping range	mm ²

16 x 65 x 52.5
27 / 10
0.5...10

Technical data

Rated data	
Rated voltage	V
Rated current	A
Rated cross-section	mm ²
Rated impulse voltage / Pollution severity	kV/-
Gauge to IEC 60947-1 / UL94 Flammability class	
Approvals	
Clamped conductors (H05V/H07V)	
solid / stranded	mm ²
flexible / Stranded wire with end ferrules	mm ²
Tightening torque range (clamping screw)	
Stripping length / Blade size	mm/-
Note	

IEC	UL	CSA
115		
27		
6		
	/ 3	
	A5 / 5VA	
Rated connection		
0.5...10		
0.5...6 / 0.5...6		
0.8...1.6 Nm (M 3.5)		
12 / 4.0 x 0.8 mm		
Note		

Ordering data

Version	
20...30 V~	
40...60V~	
80...120 V~	
115 V~	
230 V~	
Note	

Type	Qty.	Order No.
SAKT E/35 2LD 30VAC	5	1166820000
SAKT E/35 2LD 60VAC	5	0197920000
SAKT E/35 2LD 120VAC	5	0198220000
SAKT E/35 2GL 115VAC	5	0198020000
SAKT E/35 2GL 230VAC	5	0198120000
Note		

Accessories

End bracket	
EW 35	Dark beige Wemid
Note	

Type	Width	Qty.	Order No.
EW 35	8.5 mm	50	0383560000
Note			

(see assortment in catalogue 7)

For detailed information on other accessories and applications, refer to the „Accessories“ section

To safe the test sockets use the SD-blade or bits with pilots!

Operating mode

SAKT E

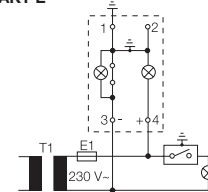

- Slide link is closed
- Auxiliary circuit is **earthed**
- Display is illuminated green

Test position

When measuring insulation resistance with voltages greater than UNom, the earth connection must first be disconnected.

SAKT E

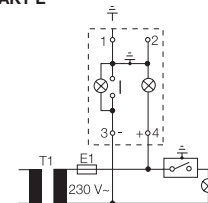

- Slide link is opened
- Auxiliary circuit is **not earthed**
- **No** earth fault
- Display illuminated green and red with reduced intensity
- Disconnected earth connection -> When measuring insulation resistance with voltages greater than UNom, the earth connection must be disconnected.

Operational malfunction

SAKT E

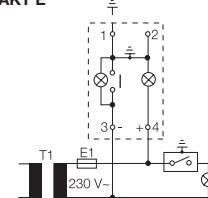

- Slide link is opened
- Auxiliary circuit is **not earthed**
- **Earth fault**
- Display is illuminated red

SAK-Series TS 32

SAK-Series TS 32

Feed-through terminal	
TS 32 / PA	B.2
TS 32 / KrG	B.6
Two-tier modular terminals	
TS 32 / PA	B.10
Modular PE terminals	
TS 32 / PA	B.12
TS 32	B.14
Disconnect terminals	
TS 32 / PA	B.16
TS 32 / KrG	B.18
Fuse terminals	
TS 32 / PA	B.20
TS 32 / KrG	B.22
Fuse inserts and gauge rings for Weidmüller fuse terminals	B.26
Terminals with spring-loaded cable clamps	
TS 32	B.28
Test-disconnect terminals	
TS 32 / KrG	B.30
Terminals for temperature measuring circuits	
TS 32 / PA	B.34
Terminals with screw-less connections	
With push-on connection TS 32 / PA	B.36
With Termi-Point / Wire-Wrap connection TS 32 / PA	B.38
With solder connection TS 32 / PA	B.39
With push-on connection TS 32 / KrG	B.42
With solder connection TS 32 / KrG	B.45
Special terminals – SAKG	
TS 32 / KrG	B.46
Stud terminal – KST	
TS 32 / PA	B.54
Terminals with electronic components	
With indication	B.56
With diodes	B.58
With electronic components	B.61
Earth conductor isolating terminals	B.62

Feed-through terminal

TS 32 / PA

In hazardous area applications, the installation instructions and the rated data specifications for accessories given in the technical appendix must be followed.

Width/Length/height with TS32x7.5	mm
max. current / max. cond. cross-section	A/mm ²
Max. clamping range	mm ²

Technical data

Rated data	
Rated voltage	V
Rated current	A
Rated cross-section	mm ²
Rated impulse voltage / Pollution severity	kV/-
Gauge to IEC 60947-1 / UL94 Flammability class	
Approvals	
Clamped conductors (H05V/H07V)	
solid / stranded	mm ²
flexible / Stranded wire with end ferrules	mm ²
Tightening torque range (clamping screw)	
Stripping length / Blade size	mm/-
2 conductors with same cross-section (H05V/H07V)	
solid / stranded	mm ²
flexible / Stranded wire with end ferrules	mm ²
Note	

Ordering data

Version	
	beige
	Blue
Note	

Accessories

Screwable cross-connection	
	2-pole
	3-pole
	4-pole
	10-pole
	Connecting sleeve
	Mounting screw
	Lock washer
Switchable link	
	Switchable link
	Connecting sleeve
	Mounting screw
Testing / Checking	
	Test plug
	Socket
End plate / Partition plate	
	beige
	Blue
	beige
	Blue
Small partition	
	Small partition
Cover / warning label	
	Cover / warning label
	Mounting screw (plastic)
Marking systems (see assortment in catalogue 7)	
	Marking tags
For detailed information on other accessories and applications, refer to the „Accessories“ section	

SAKD 2.5N

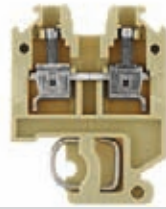
2.5 mm²

5 x 32.5 x 43.5
30 / 4
0.08...4

IEC 60947-7-1

IEC	UL	CSA
500	300	300
24	20	20
2.5	AWG 28...12	AWG 22...12
6 / 3		
A2 / V2		

Rated connection

0.5...4 / 0.5...2.5
0.5...4 / 0.5...2.5
0.4...0.6 Nm (M 2.5)
10 / 0.6 x 3.5 mm

0.5...0.75	mm ²
0.5...0.75 / 0.5...0.75	mm ²

With twin ferrules ZH 0.5 to ZH 1.5, rated voltage is 690 V.

Type	Qty.	Order No.
SAKD 2.5N	100	0215560000
SAKD 2.5N BL	100	0215580000

Type	current	Qty.	Order No.
Q 2 SAKD2.5N	24 A	50	0367800000
Q 3 SAKD2.5N	24 A	50	0367900000
Q 4 SAKD2.5N	24 A	50	0368000000
Q 10 SAKD2.5N	24 A	20	0368100000

Width		Qty.	Order No.
PS 2.3 RT	5.4 mm	20	0180400000
STB 8.5/D4/2.3/M2.5 AKZ		50	0215700000

Width		Qty.	Order No.
AP SAKD2.5N	1.5 mm	20	0150960000
AP SAKD2.5N BL	1.5 mm	20	0150980000
TW SAKD2.5N	1.5 mm	20	0191860000
TW SAKD2.5N BL	1.5 mm	20	0191880000

Type	Width	Qty.	Order No.
TSCH 3 SAKD2.5 N	5 mm	100	0366860000

DEK 5/5 / SCHT 7

SAK 2.5

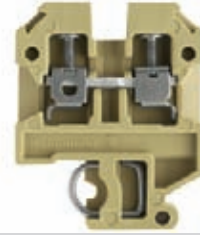
2.5 mm²

6 x 36.5 x 46.5
41 / 6
0.13...6

IEC 60947-7-1

Ex e ll  II 2 G D

IEC	UL	CSA	EN 60079-7
800	600	600	550
24	20	25	21
2.5	AWG 22...12	AWG 26...10	2.5
8 / 3			
A3 / V2			



KEMA 97ATEX1798 U

Rated connection

0.5...6 / 0.5...4
0.5...4 / 0.5...4
0.4...0.6 Nm (M 2.5)
10 / 0.6 x 3.5 mm

0.5...1.5	mm ²
0.5...1.5	mm ²

With twin ferrules ZH 0.5 to ZH 1.5, rated voltage is 690 V.

Type	Qty.	Order No.
SAK 2.5	100	0279660000
SAK 2.5 BL	100	0279680000

Type	current	Qty.	Order No.
Q 2 SAK2.5	41 A	50	0337000000
Q 3 SAK2.5	41 A	50	0337100000
Q 4 SAK2.5	41 A	50	0337200000
Q 10 SAK2.5	41 A	20	0368700000

Width		Qty.	Order No.
PS 2.3 RT	5.4 mm	20	0180400000
STB 8.5/5/2.3/M3 SAK2.5		50	0280600000

Width		Qty.	Order No.
AP SAK2.5	1.5 mm	20	0279560000
AP SAK2.5 BL	1.5 mm	20	0279580000
TW SAK2.5	2.5 mm	20	0302860000
TW SAK2.5 BL	1.5 mm	20	0302880000

Type	Width	Qty.	Order No.
TSCH 1	2 mm	100	0319160000

AD 3 SAK2.5	50	0297900000
BFSC M3x22 PA/RT	100	0128900000

DEK 5/6 / SCHT 7

SAK 4

4 mm²

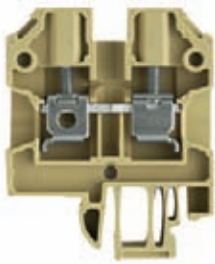

6.5 x 40 x 51.5
41 / 6
0.13...6

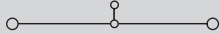

IEC 60947-7-1 Ex e II II 2 G D

IEC	UL	CSA	EN 60079-7
800	600	600	550
32	20	36	28
4	AWG 22...12	AWG 26...10	4
8 / 3			
A4 / V2			

KEMA 97ATEX1798 U

Rated connection

0.5...6 / 0.5...4
0.5...4 / 0.5...4
0.5...1.0 Nm (M 3)
12 / 0.6 x 3.5 mm

1.5...1.5
0.5...1.5

With twin ferrules ZH 0.5 to ZH 2.5, rated voltage is 690 V.

Type	Qty.	Order No.
SAK 4	100	1716240000
SAK 4 BL	100	0128380000

Type	current	Qty.	Order No.
Q 2 SAK4	41 A	50	0336700000
Q 3 SAK4	41 A	50	0336800000
Q 4 SAK4	41 A	50	0336900000
Q 10 SAK4	41 A	20	0368800000
Width			
VL 2 SAK4	32 A	50	0197000000
VH 19/5/3.5 SAK4-16		50	0285100000
BFSC M3X25		100	0292500000
Width			
PS 4 F.STB 4	7.6 mm	20	0299600000
STB 14/D5/2.3/M3 SAK2.5		50	0168600000
AP SAK4-10	1.5 mm	20	0117960000
AP SAK4-10 BL	1.5 mm	20	0117980000
TW 4 SAK4-10	1.5 mm	20	0130160000
TW 4 SAK4-10 BL	1.5 mm	20	0130180000
TSCH 1	2 mm	100	0319160000
AD 4 SAK4		50	0285300000
BFSC M3X22 PA/RT		100	0128900000

DEK 5/6,5

SAK 6 N

6 mm²



8 x 40 x 51.5
57 / 10
0.33...10

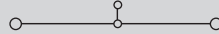

IEC 60947-7-1 Ex e II II 2 G D

IEC	UL	CSA	EN 60079-7
800	600	600	550
41	40	47	36
6	AWG 22...8	AWG 20...8	6
8 / 3			
A5 / V2			

KEMA 97ATEX1798 U

Rated connection

0.5...10 / 0.5...6
0.5...10 / 0.5...6
0.8...1.6 Nm (M 3.5)
12 / 4.0 x 0.8 mm

For AWG 8-7 and AWG 8-19, tightening torque is 1.21.4 Nm

Type	Qty.	Order No.
SAK 6N	100	0193260000
SAK 6N BL	100	0193280000

With AWG 6 and H07V-R10 conductors, an increased MD torque of 1.4 to 1.6 Nm should be used.

Type	current	Qty.	Order No.
Q 2 SAK6N	32 A	50	0456700000
Q 3 SAK6N	57 A	50	0456800000
Q 4 SAK6N	57 A	50	0456900000
Q 10 SAK6N	32 A	20	0457000000
Width			
VL 2 SAK6/10/SAKB	32 A	50	0135900000
VH 19/5/3.5 SAK4-16		50	0285100000
BFSC M3X25		100	0292500000
Width			
PS 4 F.STB 4	7.6 mm	20	0299600000
STB 14/D6/4/M3 SAK10		50	0169900000
AP SAK4-10	1.5 mm	20	0117960000
AP SAK4-10 BL	1.5 mm	20	0117980000
TW 4 SAK4-10	1.5 mm	20	0130160000
TW 4 SAK4-10 BL	1.5 mm	20	0130180000
TSCH 1	2 mm	100	0319160000
AD 4 SAK6N		50	0196600000
BFSC M3X22 PA/RT		100	0128900000

DEK 5/8 / SCHAT 7

When used with twin ferrules ZH 0.5 - ZH 4, the rated voltage is 690 V.

SAK 10

10 mm²



10 x 40 x 51.5
76 / 16
1.5...16

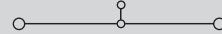

IEC 60947-7-1 Ex e II II 2 G D

IEC	UL	CSA	EN 60079-7
800	600	600	550
57	60	65	50
10	AWG 14...6	AWG 16...6	10
8 / 3			
B6 / V2			

KEMA 97ATEX1798 U

Rated connection

1.5...10 / 1.5...16
1.5...16 / 1.5...10
2.0...4.0 Nm (M 4)
12 / 1.0 x 5.5 mm

When used with twin ferrules ZH 0.5 - ZH 4, the rated voltage is 690 V.

Type	Qty.	Order No.
SAK 10	100	0110060000
SAK 10 BL	100	0110080000

A higher torque of 2 to 2.4 Nm is necessary when using H07V-R16 and AWG 6 conductors.

Type	current	Qty.	Order No.
Q 2 SAK10	57 A	50	0457100000
Q 3 SAK10	57 A	50	0457200000
Q 4 SAK10	57 A	50	0457300000
Q 10 SAK10	57 A	20	0457400000
Width			
VL 2 SAK6/10/SAKB		50	0135900000
VH 19/5/3.5 SAK4-16		50	0285100000
BFSC M3X25		100	0292500000
Width			
PS 4 F.STB 4	7.6 mm	20	0299600000
STB 14/D6/4/M3 SAK10		50	0169900000
AP SAK4-10	1.5 mm	20	0117960000
AP SAK4-10 BL	1.5 mm	20	0117980000
TW 4 SAK4-10	1.5 mm	20	0130160000
TW 4 SAK4-10 BL	1.5 mm	20	0130180000
TSCH 1	2 mm	100	0319160000
AD 4 SAK10		50	0178600000
BFSC M3X22 PA/RT		100	0128900000

DEK 5/5

Feed-through terminal

TS 32 / PA

In hazardous area applications, the installation instructions and the rated data specifications for accessories given in the technical appendix must be followed.

Width/Length/height with TS32x7.5	mm
max. current / max. cond. cross-section	A/mm ²
Max. clamping range	mm ²

Technical data

Rated data	
Rated voltage	V
Rated current	A
Rated cross-section	mm ²
Rated impulse voltage / Pollution severity	kV/-
Gauge to IEC 60947-1 / UL94 Flammability class	
Approvals	
Clamped conductors (H05V/H07V)	
solid / stranded	mm ²
flexible / Stranded wire with end ferrules	mm ²
Tightening torque (clamping screw)	
Stripping length / Blade size	mm/-
2 conductors with same cross-section (H05V/H07V)	
solid / stranded	mm ²
flexible / Stranded wire with end ferrules	mm ²
Note	

Ordering data

Version	
	beige
	Blue
Note	

Accessories

Screwable cross-connection	
	2-pole
	3-pole
	4-pole
	10-pole
	Connecting sleeve
	Mounting screw
	Lock washer
Switchable link	
	Switchable link
	Connecting sleeve
	Mounting screw
Testing / Checking	
	Test plug
	Socket
End plate / Partition plate	
	beige
	Blue
	beige
	Blue
Small partition	
	Small partition
Cover / warning label	
	Cover / warning label
	Mounting screw (plastic)
Marking systems	
	(see assortment in catalogue 7)
	Marking tags
For detailed information on other accessories and applications, refer to the „Accessories“ section	

SAK 16

16 mm²

12 x 50 x 57.5

76 / 16

2.5...16

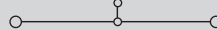

IEC 60947-7-1				Ex e ll II 2 G D			
IEC	UL	CSA	EN 60079-7	IEC	UL	CSA	EN 60079-7
1000	600	600	690	1000	600	600	690
76	80	87	66	125	105	145	109
16	AWG 12...4	AWG 14...6	16	35	AWG 12...2	AWG 12...2	35
				8 / 3			
				B6 / V2			
				KEMA 97ATEX1798 U			
Rated connection							
2.5...10 / 4...16							
4...16 / 4...16							
2.0...4.0 Nm (M 4)							
15 / 1.0 x 5.5 mm							
Twin wire end ferrules ZH 2.5 - ZH 16 can be used.							

Type	Qty.	Order No.
SAK 16	50	0271060000
SAK 16 BL	50	0271080000
If QIs are aligned side by side, then a TW/AP must be used.		

Type	current	Qty.	Order No.
Q 2 SAK16	76 A	50	0457500000
Q 3 SAK16	76 A	50	0457600000
Q 4 SAK16	76 A	50	0457700000
Q 10 SAK16	76 A	20	0457800000
Width			
PS 4 F.STB 4	7.6 mm	20	0299600000
STB 14/D6/4/M3 SAK10	50	0169900000	
AP SAK16	1.5 mm	20	0271160000
AP SAK16 BL	1.5 mm	20	0271180000
TSCH 1	2 mm	100	0319160000
AD 3 SAK16	50	0297800000	
BFSC M3X22 PA/RT	100	0128900000	
DEK 5/5			

SAK 35

35 mm²

18 x 58 x 67.5

150 / 50

2.5...50



IEC 60947-7-1				Ex e ll II 2 G D			
IEC	UL	CSA	EN 60079-7	IEC	UL	CSA	EN 60079-7
1000	600	600	550	1000	600	600	550
125	105	145	109	125	105	145	109
35	AWG 12...2	AWG 12...2	35	35	AWG 12...2	AWG 12...2	35
				8 / 3			
				B8 / V2			
				KEMA 97ATEX1798 U			
Rated connection							
2.5...16 / 4...50							
2.5...35 / 2.5...35							
4.0...5.0 Nm (M 6)							
18 / 6.5 x 1.2 mm							
2.5...10 / 10...16							
2.5...16 / 2.5...16							
The tightening torque is 4.5 Nm for 16 - 50 mm ² and AWG 6 - 2/7 stranded conductors. Twin wire end ferrules ZH 2.5 - ZH 16 can be used.							

Type	Qty.	Order No.
SAK 35	20	0303560000
SAK 35 BL	20	0303580000
It is possible to use twin ferrules with identical rated voltages (LAB 13090).		

Type	current	Qty.	Order No.
QL 2 SAK35	99 A	20	0123600000
QL 3 SAK35	99 A	20	0123700000
QL 4 SAK35	99 A	20	0123800000
QL 10 SAK35	99 A	20	0338600000
VH 17/8/5 SAK35	50	0267000000	
BFSC M4X30	50	0267100000	
SS M4 D 128-A 4	100	0136400000	
Width			
VL 2 SAK35	119 A	50	0124000000
VH 24.5/8/5 SAK35	50	0298700000	
BFSC M4X35	50	0298900000	
PS 4 F.STB 4	7.6 mm	20	0299600000
STB 16/D7/4/M4 SAK35	50	0140200000	
AP SAK35/TW SAK16	1.5 mm	10	0303660000
AP SAK35/TW SAK16 BL	1.5 mm	10	0303680000
TW SAK35	1.5 mm	20	0304360000
AD 3 SAK35	50	0273400000	
BFSC M4X32 PA/RT	100	0129100000	
DEK 5/5 / SCHT 7			
If QIs are aligned side by side, then a TW/AP must be used.			

SAK 35/IK

35 mm²

Hexagon socket head screw



18 x 58 x 67.5

150 / 50

2.5...50

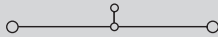

IEC 60947-7-1 Ex e II **Ex** II 2 G D

IEC	UL	CSA	EN 60079-7
1000	600	600	550
125	105	145	109
35	AWG 12...2	AWG 12...2	35
8 / 3			
B8 / V2			

KEMA 97ATEX1798 U

Rated connection

2.5...16 / 4...50

2.5...35 / 2.5...35

4.0...5.0 Nm (M 6)

18 / S4 (DIN 6911)

2.5...10 / 10...16

2.5...16 / 2.5...16

The tightening torque is 4.5 Nm for 16 - 50 mm² and AWG 6 - 2/7 stranded conductors. Twin wire end ferrules ZH 2.5 - ZH 16 can be used.

Type	Qty.	Order No.
SAK 35/IK	20	0476560000

It is possible to use twin ferrules with identical rated voltages (LAB 13090).

SAK 35 N

35 mm²



16 x 58 x 67.5

150 / 50

2.5...50

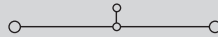

IEC 60947-7-1

IEC	UL	CSA
1000	600	600
125	105	120
35	AWG 12...2	AWG 12...2
8 / 3		
B8 / V2		

Rated connection

2.5...16 / 4...50

2.5...35 / 1.5...35

4.0...5.0 Nm (M 6)

18 / 6.5 x 1.2 mm

2.5...10 / 10...16

2.5...16 / 2.5...16

The tightening torque is 4.5 Nm for 16 - 50 mm² and AWG 6 - 2/7 stranded conductors. Twin wire end ferrules ZH 2.5 - ZH 16 can be used.

Type	Qty.	Order No.
SAK 35N	20	0550660000

It is possible to use twin ferrules with identical rated voltages (LAB 13090).

SAK 35 N/IK

35 mm²

Hexagon socket head screw



16 x 58 x 67.5

150 / 50

2.5...50

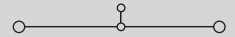

IEC 60947-7-1

IEC	UL	CSA
1000	600	600
125	105	120
35	AWG 12...2	AWG 12...2
8 / 3		
B8 / V2		

Rated connection

2.5...16 / 4...50

2.5...35 / 1.5...35

4.0...6.0 Nm (M 6)

18 / S4 (DIN 6911)

2.5...10 / 10...16

2.5...16 / 2.5...16

The tightening torque is 4.5 Nm for 16 - 50 mm² and AWG 6 - 2/7 stranded conductors. Twin wire end ferrules ZH 2.5 - ZH 16 can be used.

Type	Qty.	Order No.
SAK 35N/IK	20	0555760000

It is possible to use twin ferrules with identical rated voltages (LAB 13090).

Type	current	Qty.	Order No.
QL 2 SAK35	99 A	20	0123600000
QL 3 SAK35	99 A	20	0123700000
QL 4 SAK35	99 A	20	0123800000
QL 10 SAK35	99 A	20	0338600000
VH 17/8/5 SAK35	50	50	0267000000
BFSC M4X30	50	50	0267100000
SS M4 D 128-A 4	100	100	0136400000
Width			
VL 2 SAK35	119 A	50	0124000000
VH 24.5/8/5 SAK35	50	50	0298700000
BFSC M4X35	50	50	0298900000
Width			
PS 4 F.STB 4	7.6 mm	20	0299600000
STB 16/D7/4/M4 SAK35	50	50	0140200000
Width			
AP SAK35/TW SAK16	1.5 mm	10	0303660000
TW SAK35	1.5 mm	20	0304360000
Width			
AD 4 SAK35	50	50	0178700000
BFSC M4X32 PA/RT	100	100	0129100000

DEK 5/5

If QIs are aligned side by side, then a TW/AP must be used.

Type	current	Qty.	Order No.
QL 2 SAK35N	99 A	50	0564900000
QL 3 SAK35N	99 A	50	0565000000
QL 4 SAK35N	99 A	50	0565100000
QL 10 SAK35N	99 A	20	0565200000
VH 17/8/5 SAK35	50	50	0267000000
BFSC M4X30	50	50	0267100000
SS M4 D 128-A 4	100	100	0136400000
Width			
PS 4 F.STB 4	7.6 mm	20	0299600000
STB 16/D7/4/M4 SAK35	50	50	0140200000
Width			
AP SAK35/TW SAK16	1.5 mm	10	0303660000
AP SAK35/TW SAK16 BL	1.5 mm	10	0303680000
TW SAK35	1.5 mm	20	0304360000
Width			
AD 4 SAK35N	50	50	0576700000
BFSC M4X32 PA/RT	100	100	0129100000

DEK 5/5

If QIs are aligned side by side, then a TW/AP must be used.

Type	current	Qty.	Order No.
QL 2 SAK35N	99 A	50	0564900000
QL 3 SAK35N	99 A	50	0565000000
QL 4 SAK35N	99 A	50	0565100000
QL 10 SAK35N	99 A	20	0565200000
VH 17/8/5 SAK35	50	50	0267000000
BFSC M4X30	50	50	0267100000
SS M4 D 128-A 4	100	100	0136400000
Width			
PS 4 F.STB 4	7.6 mm	20	0299600000
STB 16/D7/4/M4 SAK35	50	50	0140200000
Width			
AP SAK35/TW SAK16	1.5 mm	10	0303660000
TW SAK35	1.5 mm	20	0304360000
Width			
AD 4 SAK35N	50	50	0576700000
BFSC M4X32 PA/RT	100	100	0129100000

DEK 5/5

If QIs are aligned side by side, then a TW/AP must be used.

Feed-through terminal

TS 32 / KrG

In hazardous area applications, the installation instructions and the rated data specifications for accessories given in the technical appendix must be followed.

Width/Length/height with TS32x7.5	mm
max. current / max. cond. cross-section	A/mm ²
Max. clamping range	mm ²

Technical data

Rated data	
Rated voltage	V
Rated current	A
Rated cross-section	mm ²
Rated impulse voltage / Pollution severity	kV/-
Gauge to IEC 60947-1 / UL94 Flammability class	
Approvals	
Clamped conductors (H05V/H07V)	
solid / stranded	mm ²
flexible / Stranded wire with end ferrules	mm ²
Tightening torque range (clamping screw)	
Stripping length / Blade size	mm/-
2 conductors with same cross-section (H05V/H07V)	
solid / stranded	mm ²
flexible / Stranded wire with end ferrules	mm ²
Note	

Ordering data

Version	
	Medium yellow
	Blue
Note	

Accessories

Screwable cross-connection	
	2-pole
	3-pole
	4-pole
	10-pole
	Connecting sleeve
	Mounting screw
	Lock washer
Switchable link	
	Switchable link
	Connecting sleeve
	Mounting screw
Testing / Checking	
	Test plug
	Socket
End plate / Partition plate	
	Medium yellow
	Blue
	Medium yellow
	Blue
Small partition	
	Small partition
Cover / warning label	
	Cover / warning label
	Mounting screw (plastic)
Marking systems (see assortment in catalogue 7)	
	Marking tags
For detailed information on other accessories and applications, refer to the „Accessories“ section	

SAK 2.5

2.5 mm²

6 x 36.5 x 46.5	
32 / 6	
0.13...6	

IEC 60947-7-1				Ex e ll II 2 G D			
IEC	UL	CSA	EN 60079-7	IEC	UL	CSA	EN 60079-7
800	600	600	550	800	600	600	550
24	20	25	21	32	20	36	28
2.5	AWG 22...12	AWG 26...10	2.5	4	AWG 22...12	AWG 26...10	4
				8 / 3			
				A3 / 5VA			
				KEMA 97ATEX1798 U			
Rated connection							
0.5...6 / 0.5...4							
0.5...4 / 0.5...2.5							
0.4...0.6 Nm (M 2.5)							
10 / 0.6 x 3.5 mm							
...1.5							
0.5...1.5							
With twin ferrules ZH 0.5 to ZH 1.5, rated voltage is 690 V.							

Type	Qty.	Order No.
SAK 2.5 KRG	100	0279620000
SAK 2.5 KRG/BL	100	0279670000

Type	current	Qty.	Order No.
Q 2 SAK2.5	41 A	50	0337000000
Q 3 SAK2.5	41 A	50	0337100000
Q 4 SAK2.5	41 A	50	0337200000
Q 10 SAK2.5	41 A	20	0368700000
Width			
PS 2.3 RT	5.4 mm	20	0180400000
STB 6/D3.9/2.3/M2.5 ZB		50	0130200000
Width			
AP SAK2.5 KRG	1.5 mm	20	0279520000
AP SAK2.5 KRG BL	1.5 mm	20	0279570000
TW SAK2.5 KRG	2.5 mm	20	0302820000
TW SAK2.5 KRG/BL	2.5 mm	20	0302870000
Width			
TSCH 1	2 mm	100	0319160000
Width			
AD 4 AKZ4		50	0303400000
BFSC M3X22 PA/RT		100	0128900000
Width			
DEK 5/6 / SCHT 7			

SAK 4

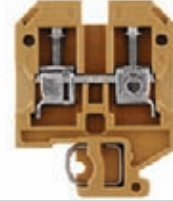
4 mm²

6.5 x 40 x 51.5	
41 / 6	
0.13...6	

IEC 60947-7-1				Ex e ll II 2 G D			
IEC	UL	CSA	EN 60079-7	IEC	UL	CSA	EN 60079-7
800	600	600	550	800	600	600	550
32	20	25	21	32	20	36	28
4	AWG 22...12	AWG 26...10	4	4	AWG 22...12	AWG 26...10	4
				8 / 3			
				A4 / 5VA			
				KEMA 97ATEX1798 U			
Rated connection							
0.5...6 / 0.5...4							
0.5...4 / 0.5...4							
0.5...1.0 Nm (M 3)							
12 / 0.6 x 3.5 mm							
0.5...1.5							
0.5...1 / 0.5...1							
With twin ferrules ZH 0.5 to ZH 2.5, rated voltage is 690 V.							

Type	Qty.	Order No.
SAK 4 KRG	100	0128320000
SAK 4 KRG BL	100	0128370000

Type	current	Qty.	Order No.
Q 2 SAK4	41 A	50	0336700000
Q 3 SAK4	41 A	50	0336800000
Q 4 SAK4	41 A	50	0336900000
Q 10 SAK4	41 A	20	0368800000
Width			
VL 2 SAK4	32 A	50	0197000000
VH 19/5/3.5 SAK4-16		50	0285100000
BFSC M3X25		100	0292500000
Width			
PS 2.3 RT	5.4 mm	20	0180400000
STB 14/D5/2.3/M3 SAK2.5		50	0168600000
Width			
AP SAK4-10 KRG	1.5 mm	20	0117920000
AP SAK4-10 KRG/BL	1.5 mm	20	0117970000
TW SAK4-10 KRG	2.5 mm	20	0130120000
TW SAK4-10 KRG/BL	2.5 mm	20	0130170000
Width			
TSCH 1	2 mm	100	0319160000
Width			
AD 4 SAK4		50	0285300000
BFSC M3X22 PA/RT		100	0128900000
Width			
DEK 5/6,5 / SCHT 7			

SAK 6 N

6 mm²

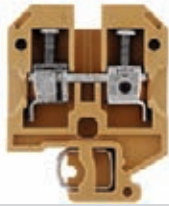

8 x 40 x 51.5
57 / 10
0.33...10

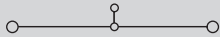

IEC 60947-7-1 Ex e ll II 2 G D

IEC	UL	CSA	EN 60079-7
800	600	600	550
41	40	47	36
6	AWG 22...8	AWG 20...8	6
8 / 3			
A5 / 5VA			

KEMA 97ATEX1798 U

Rated connection
0.5...10 / 0.5...6
0.5...10 / 0.5...6
0.8...1.6 Nm (M 3.5)
12 / 4.0 x 0.8 mm

When used with twin ferrules ZH 0.5 - ZH 4, the rated voltage is 690 V.

Type	Qty.	Order No.
SAK 6N KRG	100	0193220000

With AWG 6 and H07V-R10 conductors, an increased MD torque of 1.4 to 1.6 Nm should be used.

Type	current	Qty.	Order No.
Q 2 SAK6N	32 A	50	0456700000
Q 3 SAK6N	57 A	50	0456800000
Q 4 SAK6N	57 A	50	0456900000
Q 10 SAK6N	32 A	20	0457000000
VL 2 SAK6N/SAKT	32 A	50	0194700000
VH 19/5/3.5 SAK4-16		50	0285100000
BFSC M3X25		100	0292500000
Width			
PS 4 F.STB 4	7.6 mm	20	0299600000
AP SAK4-10 KRG	1.5 mm	20	0117920000
AP SAK4-10 KRG/BL	1.5 mm	20	0117970000
TW SAK4-10 KRG	2.5 mm	20	0130120000
TW SAK4-10 KRG/BL	2.5 mm	20	0130170000
TSCH 1	2 mm	100	0319160000
AD 4 SAK6N		50	0196600000
BFSC M3X22 PA/RT		100	0128900000

DEK 5/8 / SCHT 7

SAK 10

10 mm²



10 x 40 x 51.5
76 / 16
1.5...16

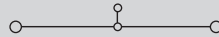

IEC 60947-7-1 Ex e ll II 2 G D

IEC	UL	CSA	EN 60079-7
800	600	600	550
57	60	65	50
10	AWG 14...6	AWG 16...6	10
8 / 3			
B6 / 5VA			

KEMA 97ATEX1798 U

Rated connection
1.5...10 / 1.5...16
1.5...16 / 1.5...10
2.0...4.0 Nm (M 4)
12 / 1.0 x 5.5 mm

When used with twin ferrules ZH 0.5 - ZH 4, the rated voltage is 690 V.

Type	Qty.	Order No.
SAK 10 KRG	100	0110020000
SAK 10 KRG/BL	100	0110070000

A higher torque of 2 to 2.4 Nm is necessary when using H07V-R16 and AWG 6 conductors.

Type	current	Qty.	Order No.
Q 2 SAK10	57 A	50	0457100000
Q 3 SAK10	57 A	50	0457200000
Q 4 SAK10	57 A	50	0457300000
Q 10 SAK10	57 A	20	0457400000
VL 2 SAK6/10/SAKB	32 A	50	0135900000
VH 19/5/3.5 SAK4-16		50	0285100000
BFSC M3X25		100	0292500000
Width			
PS 4 F.STB 4	7.6 mm	20	0299600000
STB 14/D6/4/M3 SAK10		50	0169900000
AP SAK4-10 KRG	1.5 mm	20	0117920000
AP SAK4-10 KRG/BL	1.5 mm	20	0117970000
TW SAK4-10 KRG	2.5 mm	20	0130120000
TW SAK4-10 KRG/BL	2.5 mm	20	0130170000
TSCH 1	2 mm	100	0319160000
AD 4 SAK10		50	0178600000
BFSC M3X22 PA/RT		100	0128900000

DEK 5/5

SAK 16

16 mm²



12 x 50 x 57.5
76 / 16
2.5...16

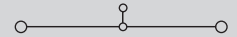

IEC 60947-7-1 Ex e ll II 2 G D

IEC	UL	CSA	EN 60079-7
1000	600	600	690
76	80	87	66
16	AWG 12...4	AWG 14...6	16
8 / 3			
B6 / 5VA			

KEMA 97ATEX1798 U

Rated connection
2.5...10 / 4...16
4...16 / 4...16
2.0...4.0 Nm (M 4)
15 / 1.0 x 5.5 mm

Twin wire end ferrules ZH 2.5 - ZH 16 can be used.

Type	Qty.	Order No.
SAK 16 KRG	50	0271020000

If QIs are aligned side by side, then a TW/AP must be used.

Type	current	Qty.	Order No.
Q 2 SAK16	76 A	50	0457500000
Q 3 SAK16	76 A	50	0457600000
Q 4 SAK16	76 A	50	0457700000
Q 10 SAK16	76 A	20	0457800000
VL 2 SAK16/SAKA	57 A	50	0135800000
VH 19/5/3.5 SAK4-16		50	0285100000
BFSC M3X25		100	0292500000
Width			
PS 4 F.STB 4	7.6 mm	20	0299600000
STB 14/D6/4/M3 SAK10		50	0169900000
AP SAK16 KRG	3 mm	20	0271120000
AP SAK35/TW SAK16 BL	1.5 mm	10	0303680000
TW SAK16 KRG	3 mm	20	0281120000
TSCH 1	2 mm	100	0319160000
AD 4 SAK16		50	0518200000
BFSC M3X22 PA/RT		100	0128900000

DEK 5/5

Feed-through terminal

TS 32 / KrG

In hazardous area applications, the installation instructions and the rated data specifications for accessories given in the technical appendix must be followed.

Width/Length/height with TS32x7.5	mm
max. current / max. cond. cross-section	A/mm ²
Max. clamping range	mm ²

Technical data

Rated data	
Rated voltage	V
Rated current	A
Rated cross-section	mm ²
Rated impulse voltage / Pollution severity	kV/-
Gauge to IEC 60947-1 / UL94 Flammability class	
Approvals	
Clamped conductors (H05V/H07V)	
solid / stranded	mm ²
flexible / Stranded wire with end ferrules	mm ²
Tightening torque (clamping screw)	
Stripping length / Blade size	mm/-
2 conductors with same cross-section (H05V/H07V)	
solid / stranded	mm ²
flexible / Stranded wire with end ferrules	mm ²
Note	

Ordering data

Version	
	Medium yellow
	Blue
Note	

Accessories

Screwable cross-connection	
	2-pole
	3-pole
	4-pole
	10-pole
	Connecting sleeve
	Mounting screw
	Lock washer
Switchable link	
	Switchable link
	Connecting sleeve
	Mounting screw
Testing / Checking	
	Test plug
	Socket
End plate / Partition plate	
	Medium yellow
	Blue
	Medium yellow
	Blue
Small partition	
	Small partition
Cover / warning label	
	Cover / warning label
	Mounting screw (plastic)
Marking systems	(see assortment in catalogue 7)
	Marking tags
For detailed information on other accessories and applications, refer to the „Accessories“ section	

SAK 35

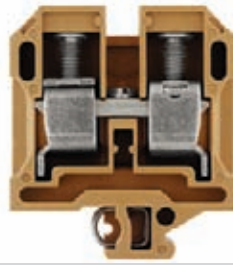
35 mm²

18 x 58 x 67.5	
125 / 50	
6...50	

IEC 60947-7-1	Ex e ll	Ex	ll 2 G D
IEC	UL	CSA	EN 60079-7
1000	600	600	550
125	105	145	109
35	AWG 6...2	AWG 6...2	35
8 / 3			
B9 / 5VA			
KEMA 97ATEX1798 U			
Rated connection			
6...16 / 16...50			
10...35 / 10...35			
5,0 Nm (M 6)			
20 / 6.5 x 1.2 mm			
The tightening torque is 4.5 Nm for 16 - 50 mm ² and AWG 6 - 2/7 stranded conductors. Twin wire end ferrules ZH 2.5 - ZH 16 can be used.			

Type	Qty.	Order No.
SAK 35 KRG	20	0303520000
It is possible to use twin ferrules with identical rated voltages (LAB 13090).		

Type	current	Qty.	Order No.
QL 2 SAK35	99 A	20	0123600000
QL 3 SAK35	99 A	20	0123700000
QL 4 SAK35	99 A	20	0123800000
QL 10 SAK35	99 A	20	0338600000
VH 17/8/5 SAK35		50	0267000000
BFSC M4X30		50	0267100000
SS M4 D 128-A 4		100	0136400000
Width			
VL 2 SAK35	119 A	50	0124000000
VH 24.5/8/5 SAK35		50	0298700000
BFSC M4X35		50	0298900000
Width			
PS 4 F.STB 4	7.6 mm	20	0299600000
STB 16/D7/4/M4 SAK35		50	0140200000
Width			
AP SAK35 KRG	3 mm	10	0303620000
AP SAK35 KRG/BL	3 mm	10	0303670000
TW SAK35 KRG	3 mm	20	0304320000
Width			
AD 4 SAK35		50	0178700000
BFSC M4X32 PA/RT		100	0129100000
Width			
DEK 5/5 / SCHAT 7			
If QIs are aligned side by side, then a TW/AP must be used.			

SAK 35/IK

35 mm²

Hexagon socket head screw

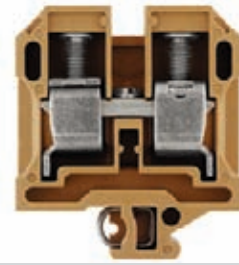

18 x 58 x 67.5	
125 / 50	
6...50	

IEC 60947-7-1	Ex e ll	Ex	ll 2 G D
IEC	UL	CSA	EN 60079-7
1000	600	600	550
125	105	145	109
35	AWG 6...2	AWG 6...2	35
8 / 3			
B9 / 5VA			
KEMA 97ATEX1798 U			
Rated connection			
6...16 / 16...50			
10...35 / 10...35			
5,0 Nm (M 6)			
20 / S4 (DIN 6911)			
The tightening torque is 4.5 Nm for 16 - 50 mm ² and AWG 6 - 2/7 stranded conductors. Twin wire end ferrules ZH 2.5 - ZH 16 can be used.			

Type	Qty.	Order No.
SAK 35/IK KRG	20	0476520000
It is possible to use twin ferrules with identical rated voltages (LAB 13090).		

Type	current	Qty.	Order No.
QL 2 SAK35	99 A	20	0123600000
QL 3 SAK35	99 A	20	0123700000
QL 4 SAK35	99 A	20	0123800000
QL 10 SAK35	99 A	20	0338600000
VH 17/8/5 SAK35		50	0267000000
BFSC M4X30		50	0267100000
SS M4 D 128-A 4		100	0136400000
Width			
VL 2 SAK35	119 A	50	0124000000
VH 24.5/8/5 SAK35		50	0298700000
BFSC M4X35		50	0298900000
Width			
PS 4 F.STB 4	7.6 mm	20	0299600000
STB 16/D7/4/M4 SAK35		50	0140200000
Width			
AP SAK35 KRG	3 mm	10	0303620000
TW SAK35 KRG	3 mm	20	0304320000
Width			
AD 4 SAK35		50	0178700000
BFSC M4X32 PA/RT		100	0129100000
Width			
DEK 5/5			
If QIs are aligned side by side, then a TW/AP must be used.			

SAK 35 N

35 mm²



16 x 58 x 67.5
125 / 50
2.5...50

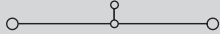

IEC 60947-7-1

IEC	UL	CSA
1000	600	600
125	105	120
35	AWG 12...2	AWG 12...2
8 / 3		
B8 / 5VA		



Rated connection

2.5...16 / 4...50
 2.5...35 / 1.5...35
 4.0...5.0 Nm (M 6)
 18 / 6.5 x 1.2 mm

The tightening torque is 4.5 Nm for 16 - 50 mm² and AWG 6 - 2/7 stranded conductors. Twin wire end ferrules ZH 2.5 - ZH 16 can be used.

Type	Qty.	Order No.
SAK 35N KRG	20	0550620000

It is possible to use twin ferrules with identical rated voltages (LAB 13090).

Type	current	Qty.	Order No.
QL 2 SAK35N	99 A	50	0564900000
QL 3 SAK35N	99 A	50	0565000000
QL 4 SAK35N	99 A	50	0565100000
QL 10 SAK35N	99 A	20	0565200000
VH 17/8/5 SAK35		50	0267000000
BFSC M4X30		50	0267100000
SS M4 D 128-A 4		100	0136400000

Width			
PS 4 F.STB 4	7.6 mm	20	0299600000
STB 16/D7/4/M4 SAK35		50	0140200000

AP SAK35 KRG	3 mm	10	0303620000
AP SAK35 KRG/BL	3 mm	10	0303670000
TW SAK35 KRG	3 mm	20	0304320000

AD 4 SAK35N		50	0576700000
BFSC M4X32 PA/RT		100	0129100000

DEK 5/5

If QIs are aligned side by side, then a TW/AP must be used.

SAK 70

70 mm²



22 x 75 x 79.5
192 / 70
16...70

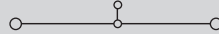

IEC 60947-7-1

IEC	UL	CSA
1000	600	600
192	150	150
70	AWG 4...2/0	AWG 4...2/0
8 / 3		
B11 / 5VA		



Rated connection

16...16 / 16...70
 16...70 / 16...35
 6.0...12 Nm (M 8)
 24 / S6 (DIN 6911)

Connection torque H07V-R70 = 12 Nm

Type	Qty.	Order No.
SAK 70 KRG	10	0340820000
SAK 70 KRG/BL	10	0340870000

Type	current	Qty.	Order No.
QL 2 SAK70	192 A	20	0345300000
QL 3 SAK70	192 A	5	0167000000
VH 30.5/11/5.5 SAK70		20	0345500000
BFSC M5X45		20	0345600000
SS M5 D 128-A 5		50	0346100000

Width			
PS 4 F.STB 4	7.6 mm	20	0299600000
STB 16/D7/4/M5 SAK70		50	0385400000

AP 70 SAK70 KRG	4 mm	10	0340920000
-----------------	------	----	-------------------

AD 3 SAK70		10	0344300000
BFSC M5X45 PA/NA		50	0344400000

DEK 5/5

SAK 95

95 mm²



28 x 87.9 x 100.5
232 / 120
16...120

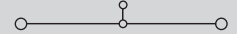

IEC 60947-7-1

IEC	UL	CSA
1000	600	600
232	190	200
95	AWG 6...4/0	AWG 6...4/0
8 / 3		
B13 / 5VA		



Rated connection

16...16 / 16...120
 16...95 / 10...95
 16...20 Nm (M 10)
 30 / S8 (DIN 6911)

Ribbon cable (segmented ribbon) can be connected ranging from 3 to 6 segments of 0.8x9 mm, up to 6 segments of 0.8x16 mm and up to 6 segments of 0.5x13 mm.

Type	Qty.	Order No.
SAK 95 KRG	10	0550520000

Type	current	Qty.	Order No.
QL 2 SAKG28		10	0551200000
QL 3 SAKG28		5	0407600000
QL 4 SAKG28		5	0407700000
VH 35/11/5.5 SAK95		10	0551100000
KISC M5X50/26 SAK95		20	0630200000

Width			
PS 4 F.STB 4	7.6 mm	20	0299600000
STB 16/D7/4/M5 SAK70		50	0385400000

AP SAK95 KRG	3 mm	10	0550920000
--------------	------	----	-------------------

BFSC M5X45 PA/NA		50	0344400000
------------------	--	----	-------------------

DEK 5/5

Two-tier modular terminals

TS 32 / PA

In hazardous area applications, the installation instructions and the rated data specifications for accessories given in the technical appendix must be followed.

Width/Length/height with TS32x7.5	mm
max. current / max. cond. cross-section	A/mm ²
Max. clamping range	mm ²



Technical data

Rated data	
Rated voltage	V
Rated current	A
Rated cross-section	mm ²
Rated impulse voltage / Pollution severity	kV/-
Gauge to IEC 60947-1 / UL94 Flammability class	
Approvals	
Clamped conductors (H05V/H07V)	
solid / stranded	mm ²
flexible / Stranded wire with end ferrules	mm ²
Tightening torque range (clamping screw)	
Stripping length / Blade size	mm/-
2 conductors with same cross-section (H05V/H07V)	
solid / stranded	mm ²
flexible / Stranded wire with end ferrules	mm ²
Note	

Ordering data

Version	
	beige
	Blue
Note	

Accessories

Screwable cross-connection	
	2-pole
	3-pole
	4-pole
	10-pole
Testing / Checking	
	Test plug
	Socket
End plate / Partition plate	
	beige
	Blue
	Dark beige Wemid
Small partition	
	Small partition
Cover / warning label	
	Cover / warning label
	Mounting screw (plastic)

Marking systems (see assortment in catalogue 7)
Marking tags

For detailed information on other accessories and applications, refer to the „Accessories“ section

DK 4

4 mm²

6 x 50 x 59.5	
41 / 6	
0.13...6	

IEC 60947-7-1 Ex e ll  II 2 G D

IEC	UL	CSA	EN 60079-7
500	300	300	275
32	27	10	28
4	AWG 22...12	AWG 26...10	4
6 / 3			
A3 / V2			

 SIRA 02ATEX3316U

Rated connection	
0.5...6 / 0.5...4	
0.5...4 / 0.5...2.5	
0.5...0.8 Nm (M 3)	
9 / 0.6 x 3.5 mm	
0.5...1.5	
0.5...1.5 / 0.5...1.5	
With twin ferrules ZH 0.5 to ZH 2.5, rated voltage is 690 V.	

Type	Qty.	Order No.
DK 4	100	0355460000
DK 4 BL	100	0355480000

Type	current	Qty.	Order No.
Q 2 AKZ4	32 A	50	0336400000
Q 3 AKZ4	32 A	50	0336500000
Q 4 AKZ4	32 A	50	0336600000
Q 10 AKZ4	32 A	20	0368600000
Width			
PS 2.3 RT	5.4 mm	20	0180400000
STB 8.5/D4/2.3/M2.5 AKZ		50	0215700000
AP DK4	1.5 mm	20	0359260000
AP DK4 BL	1.5 mm	20	0359280000
WTW EN	3 mm	20	1058800000
TSCH 6 DK1 S4	5 mm	100	0190260000

DEK 5/6

DK 4 Q

4 mm²

6 x 50 x 59.5	
41 / 6	
0.13...6	

IEC 60947-7-1 Ex e ll  II 2 G D

IEC	UL	CSA	EN 60079-7
500	300	300	275
32	27	10	28
4	AWG 22...12	AWG 26...10	4
6 / 3			
A3 / V2			

 SIRA 02ATEX3316U

Rated connection	
0.5...6 / 0.5...4	
0.5...4 / 0.5...2.5	
0.5...0.8 Nm (M 3)	
9 / 0.6 x 3.5 mm	
0.5...1.5	
0.5...1.5 / 0.5...1.5	
With twin ferrules ZH 0.5 to ZH 2.5, rated voltage is 690 V.	

Type	Qty.	Order No.
DK 4Q/32	100	0590060000
DK 4Q/32 BL	100	0590080000

Type	current	Qty.	Order No.
Q 2 AKZ4	32 A	50	0336400000
Q 3 AKZ4	32 A	50	0336500000
Q 4 AKZ4	32 A	50	0336600000
Q 10 AKZ4	32 A	20	0368600000
Width			
PS 2.3 RT	5.4 mm	20	0180400000
STB 8.5/D4/2.3/M2.5 AKZ		50	0215700000
AP DK4Q	1.5 mm	20	1397160000
AP DK4Q BL	1.5 mm	20	1397180000
WTW EN	3 mm	20	1058800000
TSCH 6 DK1 S4	5 mm	100	0190260000

DEK 5/6

DK 4 QV

4 mm²

6 x 54 x 59.5

41 / 6

0.13...6

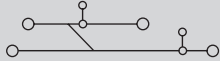

IEC 60947-7-1

Ex e II



II 2 G D

IEC	UL	CSA	EN 60079-7
500	300	300	275
32	27	10	28
4	AWG 22...12	AWG 26...12	4
6 / 3			
A3 / V2			



SIRA 02ATEX3316U

Rated connection

0.5...6 / 0.5...4

0.5...4 / 0.5...2.5

0.5...0.8 Nm (M 3)

8 / 0.6 x 3.5 mm

0.5...1.5

0.5...1.5 / 0.5...1.5

With twin ferrules ZH 0.5 to ZH 2.5, rated voltage is 690 V.

Type	Qty.	Order No.
DK 4QV/32	100	0590260000
DK 4QV/32 BL	100	0590280000

Type	current	Qty.	Order No.
Q 2 AKZ4	32 A	50	0336400000
Q 3 AKZ4	32 A	50	0336500000
Q 4 AKZ4	32 A	50	0336600000
Q 10 AKZ4	32 A	20	0368600000
Width			
PS 2.3 RT	5.4 mm	20	0180400000
STB 8.5/D4/2.3/M2.5 AKZ		50	0215700000
AP DK4Q	1.5 mm	20	1397160000
AP DK4Q BL	1.5 mm	20	1397180000
WTW EN	3 mm	20	1058800000
TSCH 6 DK1 S4	5 mm	100	0190260000
AD 4 AKZ4		50	0303400000
BFSC M2.5X18 PA/RT		100	0303300000

DEK 5/6

Modular PE terminals

TS 32 / PA

In hazardous area applications, the installation instructions and the rated data specifications for accessories given in the technical appendix must be followed.

Width/Length/height with TS32x7.5	mm
max. current / max. cond. cross-section	A/mm ²
Max. clamping range	mm ²

Technical data

Rated data	
Rated cross-section	mm ²
Rated voltage to adjacent terminal	V
Rated impulse withstand voltage to adjacent terminal	kV
Short-time withstand current	
Pollution severity	
Gauge to IEC 60947-1 / UL94 Flammability class	
Approvals	
Clamped conductors (H05V/H07V)	
solid / stranded	mm ²
flexible / Stranded wire with end ferrules	mm ²
Tightening torque range (clamping screw)	
Tightening torque range (fixing screw)	
Stripping length / Blade size	mm/-

Note

Ordering data

Version
green/yellow
Note

Accessories

Rail support

Marking systems (see assortment in catalogue 7)
Marking tags

For detailed information on other accessories and applications, refer to the „Accessories“ section

EK 2.5N

2.5 mm²

6 x 36.5 x 46.5
/ 4
0.33...4

IEC 60947-7-2 Ex e ll II 2 G D

IEC	UL	CSA	EN 60079-7
2.5	AWG 22...12	AWG 26...10	AWG 26...10
800			
8			
300 A (2.5 mm ²)			
	3		
	A3 / V2		

KEMA 97ATEX1798 U

Rated connection
0.5...4 / 0.5...2.5
0.5...4 / 0.5...2.5
0.4...0.8 Nm (M 2.5)
0.5...0.8 Nm
10 / 0.6 x 3.5 mm

Type	Qty.	Order No.
EK 2.5N	100	0474360000

Type	Width	Qty.	Order No.
SH 2	40 mm	10	0494920000

DEK 5/6

EK 4

4 mm²

8 x 40 x 51.5
/ 6
0.33...6

IEC 60947-7-2 Ex e ll II 2 G D

IEC	UL	CSA	EN 60079-7
4	AWG 22...12	AWG 26...10	AWG 26...10
800			
8			
480 A (4 mm ²)			
	3		
	A4 / V2		

KEMA 97ATEX1798 U

Rated connection
0.5...6 / 0.5...4
0.5...4 / 0.5...4
0.5...1.0 Nm (M 3)
0.5...1.0 Nm
12 / 0.6 x 3.5 mm

Type	Qty.	Order No.
EK 4	100	0354560000

Type	Width	Qty.	Order No.
SH 2	40 mm	10	0494920000

DEK 5/6,5

EK 10

10 mm²



10 x 40 x 51.5
/ 10
0.5...10

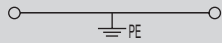

IEC 60947-7-2 Ex e II II 2 G D

IEC	UL	CSA	EN 60079-7
10	AWG 14...6	AWG 14...6	AWG 14...6
800			
8			
720 A (6 mm ²)			
3			
B6 / V2			

KEMA 97ATEX1798 U

Rated connection

0.5...10 / 1.5...6
0.5...10 / 0.5...10
1.2...1.6 Nm (M 4)
0.5...1.0 Nm
12 / 1.0 x 5.5 mm

Type	Qty.	Order No.
EK 10	100	0354660000
UNDEFINED TEXT		

Type	Width	Qty.	Order No.
SH 2	40 mm	10	0494920000

DEK 5/5

EK 16

16 mm²



12 x 50 x 57.5
/ 16
2.5...16

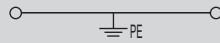

IEC 60947-7-2

IEC	UL	CSA
16	AWG 10...6	AWG 10...4
800		
8		
1920 A (16 mm ²)		
3		
B6 / V2		

KEMA 97ATEX1798 U

Rated connection

2.5...16 / 2.5...16
2.5...16 / 4...16
2.0...4.0 Nm (M 4)
0.8...1.6 Nm
16 / 1.0 x 5.5 mm

Type	Qty.	Order No.
EK 16	50	0374660000

Type	Width	Qty.	Order No.
SH 2	40 mm	10	0494920000

DEK 5/5

EK 35

35 mm²



16 x 58 x 67.5
/ 50
6...50

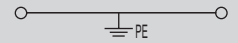

IEC 60947-7-2

IEC	UL	CSA	EN 60079-7
35	AWG 6...2	AWG 10...2	AWG 10...2
800			
8			
4200 A (35 mm ²)			
3			
B9 / V2			

KEMA 97ATEX1798 U

Rated connection

6...16 / 16...50
10...35 / 10...35
4.0...6.0 Nm (M 6)
0.8...1.6 Nm
20 / 6.5 x 1.0 mm

Type	Qty.	Order No.
EK 35	20	0354760000

Type	Width	Qty.	Order No.
SH 2	40 mm	10	0494920000

DEK 5/5

The TS 35/15 Cu must be used when connecting conductors of 50 mm².

Modular PE terminals

TS 32

In hazardous area applications, the installation instructions and the rated data specifications for accessories given in the technical appendix must be followed.

Width/Length/height with TS32x7.5 mm
 max. current / max. cond. cross-section A/mm²
 Max. clamping range mm²

Technical data

Rated data

Rated cross-section mm²
 Rated voltage to adjacent terminal -
 Rated impulse withstand voltage to adjacent terminal -
 Short-time withstand current
 Pollution severity
 Gauge to IEC 60947-1 / UL94 Flammability class
 Approvals

Clamped conductors (H05V/H07V)

solid / stranded mm²
 flexible / Stranded wire with end ferrules mm²
 Tightening torque range (clamping screw)
 Tightening torque range (fixing screw)
 Stripping length / Blade size mm/-

Note

Ordering data

Version

Note

Accessories

Rail support

EK 2

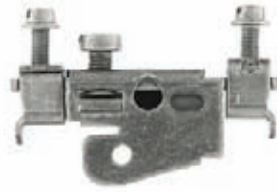
10 mm²

10.2 x 52 x 38
 / 10
 1.5...10

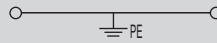

IEC 60947-7-2

IEC	UL	CSA
10	AWG 16...8	AWG 16...8
1200 A (10 mm ²)		
B6 / ---		



Rated connection

1.5...10 / 1.5...10
 1.5...10 / 1.5...10
 1.2...1.6 Nm (M 4)
 2.0...4.0 Nm
 14 / 1.0 x 5.5 mm

SAKE 35

35 mm²

14 x 46 x 39
 / 35
 6...35

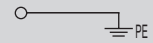

IEC 60947-7-2

IEC	UL	CSA
35	AWG 8...2	AWG 8...2
4200 A (35 mm ²)		
B8 / V-0		



Rated connection

6...35 / 6...35
 6...35 / 10...35
 4.0...5.0 Nm (M 6)
 2.0...4.0 Nm
 16 / 6.5 x 1.2 mm

(see assortment in catalogue 7)

For detailed information on other accessories and applications, refer to the „Accessories“ section

SAKE 70

70 mm²

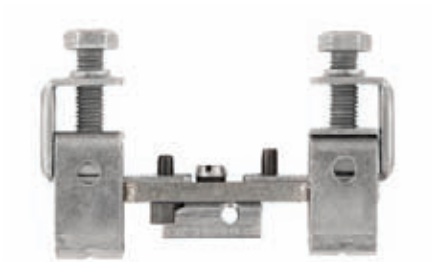

18 x 94 x 59.5

/ 70

10...70

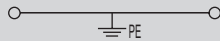

IEC 60947-7-2

IEC	UL	CSA
70		AWG 1...2/0

8400 A (70 mm²)

B10 / V-0



Rated connection

10...16 / 10...70

10...70 / 10...70

6.0...12 Nm (M 8)

2.0...4.0 Nm

25 /

When connecting with stranded conductors $\geq 50 \text{ mm}^2$ and 12 Nm tightening torque. Test current 8,4 kA to IK carried out via copper terminal rail

Type	Qty.	Order No.
SAKE 70/32	10	0213200000

Type	Width	Qty.	Order No.
SH 2	40 mm	10	0494920000

A copper TS 32 rail must be used for connecting conductors $\geq 50 \text{ mm}^2$.

Disconnect terminals

TS 32 / PA

In hazardous area applications, the installation instructions and the rated data specifications for accessories given in the technical appendix must be followed.

Width/Length/height with TS32x7.5	mm
max. current / max. cond. cross-section	A/mm ²
Max. clamping range	mm ²

Technical data

Rated data	
Rated voltage	V
Rated current	A
Rated cross-section	mm ²
Rated impulse voltage / Pollution severity	kV/-
Gauge to IEC 60947-1 / UL94 Flammability class	
Approvals	
Clamped conductors (H05V/H07V)	
solid / stranded	mm ²
flexible / Stranded wire with end ferrules	mm ²
Tightening torque range (clamping screw)	
Stripping length / Blade size	mm/-
2 conductors with same cross-section (H05V/H07V)	
solid / stranded	-
flexible / Stranded wire with end ferrules	-
Note	

Ordering data

Version	
	beige
	Blue
Note	

Accessories

External cross-connection	
	2-pole
	3-pole
	4-pole
Testing / Checking	
	Test plug
	Socket
End plate / Partition plate	
	beige
	Blue
	beige
	Tropical applications

Marking systems (see assortment in catalogue 7)

Marking tags

For detailed information on other accessories and applications, refer to the „Accessories“ section

SAKR

4 mm²

6.5 x 42 x 40.5

10 / 4

0.13...4



IEC 60947-7-1

IEC	UL	CSA
400	300	300
10	10	10
4	AWG 22...12	AWG 22...12
6 / 3		
A3 / V2		



Rated connection

0.5...4 / 1.5...4

0.5...4 / 0.5...2.5

0.5...1.0 Nm (M 3)

8 / 0.6 x 3.5 mm

Torque for SAKR with socket: 0.5 - 0.7 Nm.

Type	Qty.	Order No.
SAKR	100	0412160000
SAKR BL	100	0412180000

Type	current	Qty.	Order No.
QB 2 WI RA6 IS	27 A	50	0482700000
QB 3 WI RA6 IS	27 A	50	0482800000
QB 4 WI RA6 IS	27 A	50	0482900000
Width			
PS 2.3 RT	5.4 mm	20	0180400000
STB 6/D3.7/2.3/M3 SAKR		100	0379400000
Width			
AP SAKR BE	1.5 mm	20	0211360000
AP SAKR BL	1.5 mm	20	0211380000
Width			
TW SAK2.5 HP/TF/GE/1	1 mm	20	0297100000

DEK 5/6,5 / SCHAT 7

QB 25 blank, refer to „Accessories“ section. Note that max. conductor connection with QB = 2.5 mm². Twin wire-end ferrules ZH 0.5 - ZH 1.5 can be used.

SAKR StB

4 mm²

6.5 x 42 x 40.5

10 / 4

0.13...4



IEC 60947-7-1

IEC	UL	CSA
400	300	300
10	10	10
4	AWG 22...12	AWG 22...12
6 / 3		
A3 / V2		



Rated connection

0.5...4 / 1.5...4

0.5...4 / 0.5...2.5

0.5...1.0 Nm (M 3)

8 / 0.6 x 3.5 mm

Tightening torque via the sockets is 0.5 - 0.7 Nm.

Type	Qty.	Order No.
SAKR 2STB	100	0412260000
SAKR 2STB BL	100	0412280000

Type	current	Qty.	Order No.
QB 2 WI RA6 IS	27 A	50	0482700000
QB 3 WI RA6 IS	27 A	50	0482800000
QB 4 WI RA6 IS	27 A	50	0482900000
Width			
PS 2.3 RT	5.4 mm	20	0180400000
STB 6/D3.7/2.3/M3 SAKR		100	0379400000
Width			
AP SAKR BE	1.5 mm	20	0211360000
AP SAKR BL	1.5 mm	20	0211380000
Width			
TW SAK2.5 HP/TF/GE/1	1 mm	20	0297100000

DEK 5/6,5 / SCHAT 7

QB 25 blank, refer to „Accessories“ section. Note that max. conductor connection with QB = 2.5 mm². Twin wire-end ferrules ZH 0.5 - ZH 1.5 can be used.

DKT 4

4 mm²



6 x 65 x 56.5
10 / 4
0.13...4

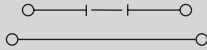

IEC 60947-7-1

IEC	UL	CSA
400	300	300
10	10	10
4	AWG 22...12	AWG 26...12
	6 / 3	
	A3 / V2	



Rated connection

0.5...4 / 1.5...4

0.5...4 / 0.5...2.5

0.5...1.0 Nm (M 3)

9 / 0.6 x 3.5 mm

DKT 4 V

4 mm²



6 x 65 x 56.5
10 / 4
0.13...4



IEC 60947-7-1

IEC	UL	CSA
400		
10		
4		
	6 / 3	
	A3 / V2	



Rated connection

0.5...4 / 1.5...4

0.5...4 / 0.5...2.5

0.5...1.0 Nm (M 3)

9 / 0.6 x 3.5 mm

Type	Qty.	Order No.
DKT 4	100	0687360000

Type	Qty.	Order No.
DKT 4V 2STB	50	1304860000

Type	current	Qty.	Order No.
QB 2 WI RA6 IS	27 A	50	0482700000
QB 3 WI RA6 IS	27 A	50	0482800000
QB 4 WI RA6 IS	27 A	50	0482900000
Width			
PS 2.3 RT	5.4 mm	20	0180400000
AP DKT4 PA	1.5 mm	20	0687560000
TW SAKS2 HP/DBR/2	2 mm	20	0607000000

Type	current	Qty.	Order No.
QB 2 WI RA6 IS	27 A	50	0482700000
QB 3 WI RA6 IS	27 A	50	0482800000
QB 4 WI RA6 IS	27 A	50	0482900000
Width			
PS 2.3 RT	5.4 mm	20	0180400000
AP DKT4 PA	1.5 mm	20	0687560000
TW SAKS2 HP/DBR/2	2 mm	20	0607000000

DEK 5/6

DEK 5/6

Disconnect terminals

TS 32 / KrG

In hazardous area applications, the installation instructions and the rated data specifications for accessories given in the technical appendix must be followed.

Width/Length/height with TS32x7.5	mm
max. current / max. cond. cross-section	A/mm ²
Max. clamping range	mm ²

Technical data

Rated data	
Rated voltage	V
Rated current	A
Rated cross-section	mm ²
Rated impulse voltage / Pollution severity	kV/-
Gauge to IEC 60947-1 / UL94 Flammability class	
Approvals	

Clamped conductors (H05V/H07V)

solid / stranded	mm ²
flexible / Stranded wire with end ferrules	mm ²
Tightening torque range (clamping screw)	
Stripping length / Blade size	mm/-

2 conductors with same cross-section (H05V/H07V)

solid / stranded	-
flexible / Stranded wire with end ferrules	-

Note

Ordering data

Version	Medium yellow
----------------	---------------

Note

Accessories

Screwable cross-connection



2-pole	
3-pole	
4-pole	
10-pole	
Connecting sleeve	
Mounting screw	
Lock washer	

Testing / Checking

Test plug	
Socket	

End plate / Partition plate

Medium yellow	
Blue	
Medium yellow	
Blue	
Tropical applications	

Marking systems (see assortment in catalogue 7)

Marking tags

For detailed information on other accessories and applications, refer to the „Accessories“ section

SAKR

4 mm²

6.5 x 42 x 40.5

10 / 4

0.13...4



IEC 60947-7-1

IEC	UL	CSA
400	300	300
10	10	10
4	AWG 22...12	AWG 22...12
6 / 3		
A3 / 5VA		



Rated connection

0.5...4 / 1.5...4
0.5...4 / 0.5...2.5
0.5...1.0 Nm (M 3)
8 / 0.6 x 3.5 mm

Torque for SAKR with socket: 0.5 - 0.7 Nm.

Type	Qty.	Order No.
SAKR KRG	100	0412120000

Type Qty. Order No.

Width			
PS 2.3 RT	5.4 mm	20	0180400000
STB 6/D3.7/2.3/M3 SAKR		100	0379400000
AP SAKR KRG	1.5 mm	20	0211320000
TW SAK2.5 HP/TF/GE/1	1 mm	20	0297100000

DEK 5/6,5 / SCHT 7

QB 25 blank, refer to „Accessories“ section. Note that max. conductor connection with QB = 2.5 mm². Twin wire-end ferrules ZH 0.5 - ZH 1.5 can be used.

SAKR StB

4 mm²

6.5 x 42 x 40.5

10 / 4

0.13...4



IEC 60947-7-1

IEC	UL	CSA
400	300	300
10	10	10
4	AWG 22...12	AWG 22...12
6 / 3		
A3 / 5VA		



Rated connection

0.5...4 / 1.5...4
0.5...4 / 0.5...2.5
0.5...1.0 Nm (M 3)
8 / 0.6 x 3.5 mm

Tightening torque via the sockets is 0.5 - 0.7 Nm.

Type	Qty.	Order No.
SAKR 2STB KRG	100	0412220000

Type Qty. Order No.

Width			
PS 2.3 RT	5.4 mm	20	0180400000
STB 6/D3.7/2.3/M3 SAKR		100	0379400000
AP SAKR KRG	1.5 mm	20	0211320000
TW SAK2.5 HP/TF/GE/1	1 mm	20	0297100000

DEK 5/6,5 / SCHT 7

QB 25 blank, refer to „Accessories“ section. Note that max. conductor connection with QB = 2.5 mm². Twin wire-end ferrules ZH 0.5 - ZH 1.5 can be used.

SAKC 4

4 mm²

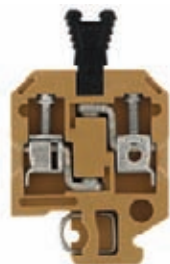

6.5 x 40 x 51.5
25 / 6
0.33...6



IEC 60947-7-1

IEC	UL	CSA
400	300	300
25	25	25
4	AWG 22...12	AWG 22...10
	6 / 3	
	A4 / 5VA	



Rated connection

0.5...6 / 1.5...4
 0.5...4 / 0.5...4
 0.5...1.0 Nm (M 3)
 12 / 0.6 x 3.5 mm

Tightening torque via the sockets is 0.5 - 0.7 Nm.

Type	Qty.	Order No.
SAKC 4 KRG	100	0340720000
SAKC 4 2STB 7 order no. 0340620000		

Type	Qty.	Order No.
Width		
PS 2.3 RT	5.4 mm	20 0180400000
STB 7/D4/2.3/M3 ZB/SAKC		100 0358500000
Width		
AP SAK4-10 KRG	1.5 mm	20 0117920000
AP SAK4-10 KRG/BL	1.5 mm	20 0117970000
TW SAK4-10 KRG	2.5 mm	20 0130120000
TW SAK4-10 KRG/BL	2.5 mm	20 0130170000

DEK 5/6,5

Dummy plug and pull out tool see chapter accessories

SAKC 10

10 mm²



12 x 65 x 52.5
27 / 10
0.33...10

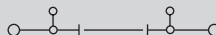

IEC 60947-7-1

IEC	UL	CSA
500	600	600
26	25	25
10	AWG 22...8	AWG 20...10
	6 / 3	
	B6 / 5VA	



Rated connection

0.5...10 / 1.5...10
 0.5...10 / 0.5...10
 1.2...2.4 Nm (M 4)
 12 / 1.0 x 5.5 mm

Tightening torque for socket is 1.2 Nm. Tightening torque is 2 Nm when connecting 10-mm² stranded conductor

Type	Qty.	Order No.
SAKC 10 2STB	50	0324120000
Version with socket (right), Art.no.: 0324020000 SAKC 10 STB/RE		

Type	current	Qty.	Order No.
QL 2 SAKA10	36 A	50	0135500000
QL 3 SAKA10	36 A	50	0135600000
QL 4 SAKA10	36 A	50	0135700000
QL 10 SAKA10	36 A	20	0338500000
VH 13.6/7/4.2 SAKA10		50	0299700000
BFSC M4X20		100	0362800000
SS M4 D 128-A 4		100	0136400000
Width			
PS 4 F.STB 4	7.6 mm	20	0299600000
STB 17/D6/4/M4 SAKC10		50	0147100000
Width			
AP SAKB-C-T I	3 mm	20	0146710000
TW SAKB-C-T	3 mm	20	0242920000

DEK 5/6,5

Pull out force look under Accessories.

Fuse terminals

TS 32 / PA

In hazardous area applications, the installation instructions and the rated data specifications for accessories given in the technical appendix must be followed.

Width/Length/height with TS32x7.5	mm
max. current / max. cond. cross-section	A/mm ²
Max. clamping range	mm ²

Technical data

Rated data	
Rated voltage	V
Rated current	A
Rated cross-section	mm ²
Rated impulse voltage / Pollution severity	kV/-
Gauge to IEC 60947-1 / UL94 Flammability class	
Approvals	

Clamped conductors (H05V/H07V)

solid / stranded	mm ²
flexible / Stranded wire with end ferrules	mm ²
Tightening torque range (clamping screw)	
Stripping length / Blade size	mm/-

2 conductors with same cross-section (H05V/H07V)

solid / stranded	mm ²
flexible / Stranded wire with end ferrules	mm ²

Note

Ordering data

Version

Note

Accessories

Screwable cross-connection

2-pole
3-pole
4-pole

G-fuse cartridge, 5 x 20mm (IEC 60127-2)

0,10 A
0,20 A
0,25 A fast
0,50 A fast
0,63 A
1,00 A fast
1,60 A
2,00 A fast
2,50 A
3,15 A
4,00 A
5,00 A
6,30 A

Contact sleeve

Marking systems (see assortment in catalogue 7)

Marking tags

For detailed information on other accessories and applications, refer to the „Accessories“ section

KSKM 1

10 mm²

5 x 20



13 x 69 x 63

6.3 / 16

0.13...16

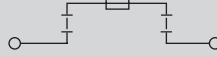

IEC	UL	CSA
250	600	
6.3	10	
10	AWG 26...8	
B6 / V-0		



Rated connection

0.5...16
0.5...10
1.2...2.4 Nm (M 4)
12 / 1.0 x 5.5 mm

KSKM 2

10 mm²

1" x 1/4"

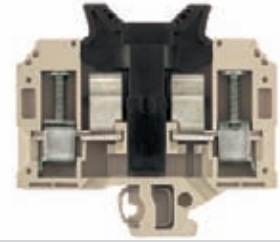

13 x 69 x 63

13 / 16

0.13...16

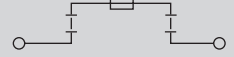

IEC	UL	CSA
250	600	
13	15	
10	AWG 26...8	
B6 / V-0		



Rated connection

0.5...16
0.5...10
1.2...2.4 Nm (M 4)
12 / 1.0 x 5.5 mm

Type	Qty.	Order No.
KSKM 1/32 G20	20	9509570000

Note

Type Qty. Order No.

Type Qty. Order No.

G 20/0.10A/F 10 0430300000

G 20/0.20A/F 10 0430400000

G 20/0.25A/F 10 0430500000

G 20/0.50A/F 10 0430600000

G 20/0.63A/F 10 0439000000

G 20/1.00A/F 10 0430700000

G 20/1.60A/F 10 0430800000

G 20/2.00A/F 10 0430900000

G 20/2.50A/F 10 0431000000

G 20/3.15A/F 10 0431100000

G 20/4.00A/F 10 0431200000

G 20/5.00A/F 10 0431300000

G 20/6.30A/F 10 0431400000

SBL/1912 10 0446100000

SBL/2111 10 0446200000

Marking systems (see assortment in catalogue 7)

DEK 5/5

Fuse 1" x 1/4" aren't available by Weidmüller.

KDKS 1

4 mm²

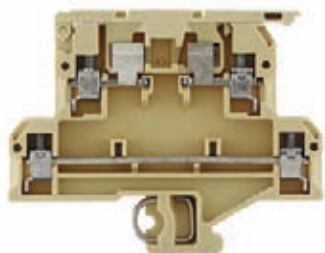

8 x 73.5 x 55.6
6.3 / 4
0.33...4

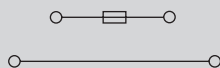

IEC 60947-7-3

IEC	UL	CSA
500	300	
6.3	10	
4	AWG 22...12	
	6 / 3	
	A3 / V2	



Rated connection

0.5...4 / 1.5...4

0.5...4 / 0.5...4

0.5...0.8 Nm (M 3)

8 / 0.6 x 3.5 mm

0.5...1.5

0.5...1.5 / 0.5...1.5

Note: max. conductor size = 2.5 mm² when using the cross-connection.

Type	Qty.	Order No.
KDKS 1/32	50	9503300000

Max. power loss (1.6 W) at the cartridge fuse limits the rated current.

Type	current	Qty.	Order No.
QB 2 WI RA8 IS	27 A	50	0461100000
QB 3 WI RA8 IS	27 A	50	0461200000
QB 4 WI RA8 IS	27 A	50	0461300000
G 20/0.10A/F		10	0430300000
G 20/0.20A/F		10	0430400000
G 20/0.25A/F		10	0430500000
G 20/0.50A/F		10	0430600000
G 20/1.00A/F		10	0430700000
G 20/1.60A/F		10	0430800000
G 20/2.00A/F		10	0430900000
G 20/2.50A/F		10	0431000000
G 20/3.15A/F		10	0431100000
G 20/4.00A/F		10	0431200000
G 20/5.00A/F		10	0431300000
G 20/6.30A/F		10	0431400000

DEK 5/8

Fuse terminals

TS 32 / KrG

In hazardous area applications, the installation instructions and the rated data specifications for accessories given in the technical appendix must be followed.

Width/Length/height with TS32x7.5	mm
max. current / max. cond. cross-section	A/mm ²
Max. clamping range	mm ²

Technical data

Rated data	
Rated voltage	V
Rated current	A
Rated cross-section	mm ²
Rated impulse voltage / Pollution severity	kV/-
Gauge to IEC 60947-1 / UL94 Flammability class	
Approvals	

Clamped conductors (H05V/H07V)

solid / stranded	mm ²
flexible / Stranded wire with end ferrules	mm ²
Tightening torque range (clamping screw)	
Stripping length / Blade size	mm/-

Note

Ordering data

Version	
	500 V AC/DC
	With GL 230 V AC/DC
	With GL 115 V AC/DC
	With LED +- 24 V DC
	500 V AC/DC

Note

Accessories

Screwable cross-connection	
	2-pole
	3-pole
	4-pole
	10-pole

End plate / Partition plate	
	Medium yellow

Marking systems (see assortment in catalogue 7)

Marking tags

For detailed information on other accessories and applications, refer to the „Accessories“ section

SAKS 1 5x20

10 mm²

13 x 54 x 61
10 / 16
0.13...16

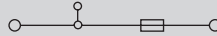

IEC	UL	CSA
500	600	600
10	6.3	10
10	AWG 22...10	AWG 26...10
6 / 3		
B6 / 5VA		



Rated connection

0.5...16 / 1.5...10
0.5...10 / 0.5...10
1.2...2.4 Nm (M 4)
12 / 1.0 x 5.5 mm

Connections for 10-mm² stranded conductors require a tightening torque of 2 Nm.

Type	Qty.	Order No.
SAKS 1/G20	20	0191220000

Type	current	Qty.	Order No.
QL 2 SAKS1	36 A	50	0191400000
QL 3 SAKS1	36 A	50	0191500000
QL 4 SAKS1	36 A	20	0191600000

	Width		
AP SAKS1+3 KRG	3 mm	20	0191320000

DEK 5/5

Refer to „Accessories“ Chapter for cross-connection accessories

SAKS 1 5x20

10 mm²

With LED or glow lamp

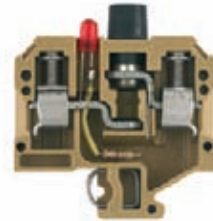

13 x 54 x 61
10 / 16
0.5...16

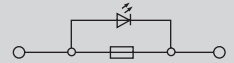

IEC	UL	CSA
500		
6.3		
10	AWG 22...8	AWG 26...10
4 /		
B6 / 5VA		



Rated connection

0.5...16 / 1.5...10
0.5...10 / 0.5...10
1.2...2.4 Nm (M 4)
12 / 1.0 x 5.5 mm

Connections for 10-mm² stranded conductors require a tightening torque of 2 Nm.

Type	Qty.	Order No.
SAKS 1/32 G20 GL 230VAC	10	0306120000
SAKS 1/32 G20 GL 115VAC	10	0385320000
SAKS 1/32 G20 LD 24VDC	10	0371420000

Type	Qty.	Order No.

	Width		
AP SAKS1+3 KRG	3 mm	20	0191320000

DEK 5/5

SAKS 1 5x25

10 mm²



13 x 54 x 61
10 / 16
0.13...16



IEC	UL	CSA
500	300	600
10	6.3	10
10	AWG 22...8	AWG 26...10
6 / 3		
B6 / 5VA		



Rated connection

0.5...16 / 1.5...10
 0.5...10 / 0.5...10
 1.2...2.4 Nm (M 4)
 12 / 1.0 x 5.5 mm

Connections for 10-mm² stranded conductors require a tightening torque of 2 Nm.

Type	Qty.	Order No.
SAKS 1/G25	20	0191120000

Type	current	Qty.	Order No.
QL 2 SAKS1	36 A	50	0191400000
QL 3 SAKS1	36 A	50	0191500000
QL 4 SAKS1	36 A	20	0191600000
QL 10 SAKS1	36 A	20	0338800000
Width			
AP SAKS1+3 KRG	3 mm	20	0191320000

DEK 5/5
 Refer to „Accessories“ Chapter for cross-connection accessories

SAKS 1 5x25

10 mm²

With glow lamp



13 x 54 x 61
6.3 / 16
0.5...16



IEC	UL	CSA
500		
6.3		
10	AWG 22...8	AWG 26...10
4 /		
B6 / 5VA		



Rated connection

0.5...16 / 1.5...10
 0.5...10 / 0.5...10
 1.2...2.4 Nm (M 4)
 12 / 1.0 x 5.5 mm

Connections for 10-mm² stranded conductors require a tightening torque of 2 Nm.

Type	Qty.	Order No.
SAKS 1/32 G25 GL 230VAC	10	0309320000

Type	Qty.	Order No.
Width		
AP SAKS1+3 KRG	3 mm	20 0191320000

DEK 5/5
 Refer to „Accessories“ Chapter for cross-connection accessories

SAKS 3

10 mm²

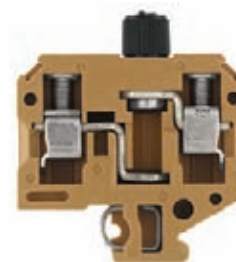

13 x 54 x 61
10 / 16
0.33...16

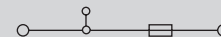

IEC	UL	CSA
500	300	600
10	10	10
10	AWG 22...8	AWG 22...10
6 / 3		
B6 / 5VA		



Rated connection

0.5...16 / 1.5...10
 0.5...10 / 0.5...10
 1.2...2.4 Nm (M 4)
 12 / 1.0 x 5.5 mm

Type	Qty.	Order No.
SAKS 3 G/5X30 500V	20	0297520000
SAKS 3 GZ/6.3X32	20	0248920000
SAKS 3 1"x1/4" with a red cap available under 0211120000.		

Type	current	Qty.	Order No.
QL 2 SAKS1	36 A	50	0191400000
QL 3 SAKS1	36 A	50	0191500000
QL 4 SAKS1	36 A	20	0191600000
QL 10 SAKS1	36 A	20	0338800000
Width			
AP SAKS1+3 KRG	3 mm	20	0191320000

DEK 5/5

Fuse terminals

TS 32 / KrG

In hazardous area applications, the installation instructions and the rated data specifications for accessories given in the technical appendix must be followed.

Width/Length/height with TS32x7.5	mm
max. current / max. cond. cross-section	A/mm ²
Max. clamping range	mm ²

Technical data

Rated data

Rated voltage	V
Rated current	A
Rated cross-section	mm ²
Rated impulse voltage / Pollution severity	kV/-
Gauge to IEC 60947-1 / UL94 Flammability class	
Approvals	

Clamped conductors (H05V/H07V)

solid / stranded	mm ²
flexible / Stranded wire with end ferrules	mm ²
Tightening torque range (clamping screw)	
Stripping length / Blade size	mm/-

Note

Ordering data

Version

Without LED

Note

Accessories

Screwable cross-connection



2-pole	
3-pole	
4-pole	
10-pole	
Mounting screw	
Lock washer	

Screw cover cap

SK

Gauge rings

Fuse cartridges

Marking systems (see assortment in catalogue 7)

Marking tags

For detailed information on other accessories and applications, refer to the „Accessories“ section

SAKS 2

10 mm²

27.6 x 80 x 75

10 / 16

0.33...16

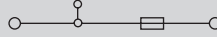

IEC 60947-7-3

IEC	UL	CSA
500		600
10		25
10		AWG 22...8
		6 / 3
		B6 / 5VA

Rated connection

0.5...16 / 0.5...10
0.5...10 / 0.5...10
1.2...2.4 Nm (M 4)
12 / 1.0 x 5.5 mm

Connections for stranded conductors from 10 mm² and 7-wire AWG conductors require a tightening torque of 2 Nm.

Type	Qty.	Order No.
SAKS 2	20	0206820000

Type	current	Qty.	Order No.
QL 2 SAKS2	36 A	20	0207800000
QL 3 SAKS2	36 A	20	0207900000
QL 4 SAKS2	36 A	20	0208000000
QL 10 SAKS2	36 A	20	0338900000
BFSC M4X9T		100	0103300000
SS M4 D 128-A 4		100	0136400000

Width

SK E16/SAKS2	25	0284110000
--------------	----	------------

P 16/10 RT SAKS2	100	0208900000
P 16/16 GR SAKS2	100	0209000000
P 16/20 BL SAKS2	100	0209100000

E 16/10A RT TNDZ	25	0208500000
E 16/16A GR TNDZ	25	0208600000
E 16/20A BL TNDZ	25	0208700000
E 16/25A GE TNDZ	25	0208800000

DEK 5/5 / SCHAT 7

SAKS 4

10 mm²

D 01-fuses

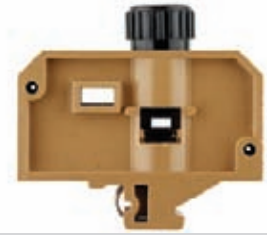

24 x 75 x 66

16 / 16

0.33...16

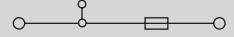

IEC 60947-7-3

IEC	UL	CSA
400		600
16		30
10		AWG 22...8
		6 / 3
		B6 / 5VA

Rated connection

0.5...16 / 1.5...10
0.5...10 / 0.5...10
1.2...2.4 Nm (M 4)
14 / 1.0 x 5.5 mm

Connections for stranded conductors from 10 mm² and 7-wire AWG conductors require a tightening torque of 2 Nm.

Type	Qty.	Order No.
SAKS 4	20	0321320000

Type	current	Qty.	Order No.
QL 2 SAKS4	36 A	20	0328000000
QL 3 SAKS4	36 A	20	0328100000
QL 4 SAKS4	36 A	20	0328200000
QL 10 SAKS4	36 A	20	0339000000
BFSC M4X9T		100	0103300000
SS M4 D 128-A 4		100	0136400000

Width

SK E14 SAKS4	20	0339410000
--------------	----	------------

P 14/2 D01 RS SAKS4	50	0138000000
P 14/4 D01 BR SAKS4	50	0138100000
P 14/10 D01 RT SAKS4	50	0328700000
P 14/6 D01 GN SAKS4	50	0328600000

E 14/2A RS	10	0137400000
E 14/4A BR	10	0137500000
E 14/6A GN	10	0328300000
E 14/10A RT	10	0328400000
E 14/16A GR	10	0328500000

DEK 5/5

SAKS 4 USA

10 mm²

1 1/4" x 1/4"



24 x 75 x 73
30 / 16
0.5...16

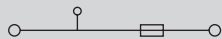

IEC	UL	CSA
400	600	600
16	30	30
10	AWG 20...8	AWG 22...8
6 / 3		
B6 / 5VA		



Rated connection

0.5...16 / 1.5...10
 0.5...10 / 0.5...10
 1.2...2.4 Nm (M 4)
 14 / 1.0 x 5.5 mm

Connections for stranded conductors from 10 mm² and 7-wire AWG conductors require a tightening torque of 2 Nm.

Type	Qty.	Order No.
SAKS 4 USA	20	0162220000

Type	current	Qty.	Order No.
QL 2 SAKS4	36 A	20	0328000000
QL 3 SAKS4	36 A	20	0328100000
QL 4 SAKS4	36 A	20	0328200000
QL 10 SAKS4	36 A	20	0339000000
BFSC M4X9T		100	0103300000
SS M4 D 128-A 4		100	0136400000
Width			
SK E14 SAKS4 USA		1	2012790000

DEK 5/5

SAKS 5

16 mm²

D 02 - fuse



28 x 80 x 66
63 / 16
1.5...16

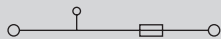

IEC 60947-7-3

IEC	UL	CSA
400	600	600
63	40	63
16	AWG 14...6	AWG 14...6
6 / 3		
B7 / 5VA		



Rated connection

1.5...16 / 1.5...16
 1.5...16 / 1.5...16
 1.2...2.4 Nm (M 4)
 13 / 1.0 x 5.5 mm

Connections for stranded conductors from 10 mm² and 7-wire AWG conductors require a tightening torque of 2 Nm.

Type	Qty.	Order No.
SAKS 5 380AC	20	0359420000

Type	current	Qty.	Order No.
QL 2 SAKS2	36 A	20	0207800000
QL 3 SAKS2	36 A	20	0207900000
QL 4 SAKS2	36 A	20	0208000000
QL 10 SAKS2	36 A	20	0338900000
BFSC M4X9T		100	0103300000
SS M4 D 128-A 4		100	0136400000
Width			
SK E18 SAKS5		20	0359310000
P 18/20 D02 BL SAKS5		50	0361800000
P 18/25 D02 GE SAKS5		50	0361900000
P 18/35 D02 SW SAKS5		50	0362000000
P 18/50 D02 WS SAKS5		50	0362100000
E 18/20A BL		10	0361300000
E 18/25A GE		10	0361400000
E 18/50A WS		10	0361600000
E 18/63A KU		10	0361700000

DEK 5/5

Partition wall TW HP (2.0) order no. 0607000000 only for TS 32

Fuse inserts

Technical data

for terminal type

SAKS 1
SAKS 7
ASK 1
WSI 6



G fuse inserts 5 x 20 without indicator acc. to IEC 60127-2 (VDE 0820 T.2 Bl 1)

Size (mm)	Rated voltage (V)	Rated current (A)	Type
5 x 20 Breaking capacity 1500 A (at 250 V, 50 Hz, cos φ 0.7)	250	0.1	(F) G 20/0.10A/F
		0.2	(F) G 20/0.20A/F
		0.25	(F) G 20/0.25A/F
		0.5	(F) G 20/0.50A/F
		0.63	(F) G 20/0.63A/F
		1.0	(F) G 20/1.00A/F
		1.6	(F) G 20/1.60A/F
		2.0	(F) G 20/2.00A/F
		2.5	(F) G 20/2.50A/F
		3.15	(F) G 20/3.15A/F
		4.0	(F) G 20/4.00A/F
		5.0	(F) G 20/5.00A/F
		6.3	(F) G 20/6.30A/F
		(M) = medium-delayed action (F) = fast	

Order data

Qty.	Order No.
10	0430300000
10	0430400000
10	0430500000
10	0430600000
10	0439000000
10	0430700000
10	0430800000
10	0430900000
10	0431000000
10	0431100000
10	0431200000
10	0431300000
10	0431400000

SAKS 1
SAKS 7
WSI 6



G fuse inserts 5 x 25 with indicator acc. to DIN 41576 1)

5 x 25 m. K.1) Breaking capacity 80 A (at 250 V, 50 Hz, cos φ = 1)	250	0.25	(M) G 25/0.25A/M		
		0.5	(M) G 25/0.50A/M		
		0.8	(M) G 25/0.80A/M		
		1	(M) G 25/1.00A/M		
		10	(M) ²⁾ G 25/10.0A/M		
		2	(F) G 25/2.00A/F		
		4	(F) G 25/4.00A/F		
		6.3	(F) G 25/6.30A/F		
		(M) = medium-delayed action (F) = fast			

10	0546900000
10	0510300000
10	0646400000
10	0265800000
10	0193100000
10	0192700000
10	0192800000
10	0192900000

SAKS 3²⁾
SAKS 6



Fuse inserts 1 1/4" x 1/4" without indicator acc. to BS 88

33 kA Breaking capacity 33 kA fast	440	0.5	GZ 0.5A/F		
		1	GZ 1.0A/F		
		2	GZ 2.0A		
		3	GZ 3.0A		
		5	GZ 5.0A		
		7	GZ 7.0A		
		10	GZ 10.0A		
		12.5	GZ 12.5A/FF		
		(F) = fast (M) = medium-delayed action			

10	0533800000
10	0525500000
10	0294500000
10	0295700000
10	0294600000
10	0295800000
10	0293900000
10	0245400000

SAKS 2



D fuse inserts E 16 with indicator acc. to DIN 49360 (diazed)

E 10 A E 16 A E 20 A E 25 A	500	10	E 16/10A RT
		16	E 16/16A GR
		20	E 16/20A BL
		25	E 16/25A GE
		(F) = fast (M) = medium-delayed action	

25	0208500000
25	0208600000
25	0208700000
25	0208800000

SAKS 4 ³⁾



D fuse inserts E 14 Size D 01 and E 18 size D 02 with indicator acc. to DIN 49522 (neozed)³⁾

E 14/2 E 14/4 E 14/6 E 14/10 E 14/16	400	2	E 14/2A RS
		4	E 14/4A BR
		6	E 14/6A GN
		10	E 14/10A RT
		16	E 14/16A GR
		E 18/20 E 18/25 E 18/35 E 18/50 E 18/63	400
25	E 18/25A GE		
35	E 18/35A SW		
50	E 18/50A WS		
63	E 18/63A KU		
(F) = fast (M) = medium-delayed action			

10	0137400000
10	0137500000
10	0328300000
10	0328400000
10	0328500000
10	0361300000
10	0361400000
10	0361500000
10	0361600000
10	0361700000

Note: 1) The SIBA company also supplies 5 x 25 G fuse inserts with indicators in a shipbuilding model for 450 V AC.
 2) 5 x 30 (500 V AC) fuse inserts for SAKS 3 are available from the WICKMANN company
 3) The LINDNER company also supplies neozed fuse cartridges in an additional shipbuilding mode for 440 V AC.
 4) Fuse cartridges with the dimensions 1"x1/2" ≅ 25.4x6.35 mm and 13/32"x1 1/2" ≅ 10.3x38.1 mm are not included in product line.
 5) Only for SAKS 1 and SAKS 7.

Gauge rings

Technical data

for terminal type

SAKS 4 and 4/35



Gauge ring type	Amp.	Colour	Type
P 14/2	2	pink	P 14/2D01 RS
P 14/4	4	brown	P 14/4D01 BR
P 14/6	6	green	P 14/6D01 GN
P 14/1	10	red	P 14/10D01 RT
P 18/20	20	blue	P 18/20D02 BL
P 18/25	25	yellow	P 18/25D02 GE
P 18/35	35	black	P 18/35D02 SW
P 18/50	50	white	P 18/50D02 WS
P 16/10	10	red	P 16/10 RT
P 16/16	16	grey	P 16/16 GR
P 16/20	20	blue	P 16/20 BL

Order data

Qty.	Order No.
50	0138000000
50	0138100000
50	0328600000
50	0328700000
50	0361800000
50	0361900000
50	0362000000
50	0362100000
100	0208900000
100	0209000000
100	0209100000

SAKS 5 and 5/35



SAKS 2 and 2/35



Terminals with spring-loaded cable clamps

TS 32

In hazardous area applications, the installation instructions and the rated data specifications for accessories given in the technical appendix must be followed.

Width/Length/height with TS32x7.5	mm
max. current / max. cond. cross-section	A/mm ²
Max. clamping range	mm ²

Technical data

Rated data	
Rated voltage	V
Rated current	A
Rated cross-section	mm ²
Rated impulse voltage / Pollution severity	kV/-
Gauge to IEC 60947-1 / UL94 Flammability class	
Approvals	
Clamped conductors (H05V/H07V)	
solid / stranded	mm ²
flexible / Stranded wire with end ferrules	mm ²
Tightening torque range (clamping screw)	
Stripping length / Blade size	mm/-

Note

Ordering data

Version
Note

Accessories

Screwable cross-connection	
	2-pole
	3-pole
	4-pole
	10-pole
	Connecting sleeve
	Mounting screw
	Lock washer
Switchable link	
	Switchable link
	Connecting sleeve
	Mounting screw
Testing / Checking	
	Test plug
	Socket
End plate / Partition plate	
	beige
	beige
Small partition	
	Small partition

Marking systems (see assortment in catalogue 7)
Marking tags

For detailed information on other accessories and applications, refer to the „Accessories“ section

RSF 3

4 mm²

Material PA 6.6

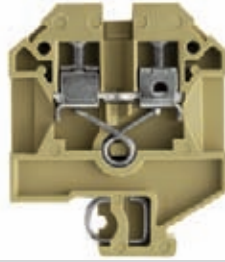

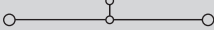
8 x 50 x 60	
32 / 4	
0.33...4	

IEC 60947-7-1

IEC	UL	CSA
630	600	600
32	20	25
4	AWG 22...12	AWG 22...12
	6 / 3	
	/ V2	



Rated connection

0.5...4 / 0.75...4
0.5...4 / 0.5...4
0.5...1.0 Nm (M 3)
12 / 0.6 x 3.5 mm

RSF 1

10 mm²

Material KrG

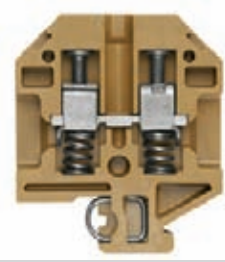

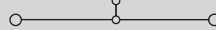
11 x 50 x 60	
57 / 10	
0.5...10	

IEC 60947-7-1

IEC	UL	CSA
500		300
57		50
10		AWG 14...8
	6 / 3	
	A5 / 5VA	



Rated connection

0.5...10 / 0.5...10
1.5...4 / 0.5...6
1.2...1.6 Nm (M 4)
15 / 1.0 x 5.5 mm

When used with an AWG 8/7 conductor, the tightening torque is 1.6 Nm.

Type	Qty.	Order No.
RSF 1 KRKG	50	0270320000

Type	Qty.	Order No.
RSF 3 PA	50	0497560000

Type	current	Qty.	Order No.
QL 2 SAK6N	32 A	50	0194300000
QL 3 SAK6N	57 A	50	0194400000
QL 4 SAK6N	57 A	50	0194500000
QL 10 SAK6N	32 A	20	0338300000
VH 13.5/4.9/3.3 SAK4		100	0248500000
KISC M3X20.5/10 EK4		100	0303000000
SS M3 D 128-A 3		50	0164400000
Width			
VL 2 SAK6N/SAKT	32 A	50	0194700000
VH 21/5/3.5 SAK16-35		50	0309600000
BFSC M3X30		50	0296200000
PS 2.3 RT	5.4 mm	20	0180400000
STB 14/D5/2.3/M3 SAK2.5		50	0168600000
Width			
AP RSF3	3 mm	10	0270460000
TW AST1/PA HP/DBR/0.5	0.5 mm	20	0474700000
TSCH 1	2 mm	100	0319160000

Type	current	Qty.	Order No.
QL 2 RSF1+2	57 A	50	0267400000
QL 3 RSF1+2	57 A	50	0267500000
QL 4 RSF1+2	41 A	50	0267600000
QL 10 RSF1+2	41 A	20	0341700000
Width			
SS M3 D 128-A 3		50	0164400000
Width			
VL 2 RSF 1+2	32 A	50	0528400000
VH 27/5/3.5 SAK10-35		50	0309400000
BFSC M3X35		50	0309800000
Width			
PS 4 F.STB 4	7.6 mm	20	0299600000
STB 14/D6/4/M3 SAK10		50	0169900000
Width			
TW AST1/PA HP/DBR/0.5	0.5 mm	20	0474700000

DEK 5/5

DEK 5/5

RSF 2

6 mm²

Material KrG

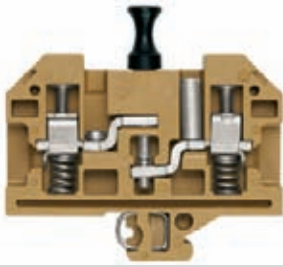

11 x 77 x 73

41 / 16

0.75...16

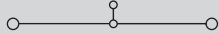

IEC 60947-7-1

IEC	UL	CSA
500		300
41		30
6		AWG 14...8
	6 / 3	
	/ 5VA	



Rated connection

0.75...16 / 0.5...10

1.5...10 / 0.5...4

1.2...2.4 Nm (M 4)

12 / 1.0 x 5.5 mm

Type	Qty.	Order No.
RSF 2	20	0623320000

Type	current	Qty.	Order No.
QL 2 RSF1+2	32 A	50	0267400000
QL 3 RSF1+2	32 A	50	0267500000
QL 4 RSF1+2	32 A	50	0267600000
QL 10 RSF1+2	32 A	20	0341700000
Width			
PS 4 F.STB 4	7.6 mm	20	0299600000
STB 17/D6/4/M4 SAKC10		50	0147100000

DEK 5/5

Test-disconnect terminals

TS 32 / KrG

In hazardous area applications, the installation instructions and the rated data specifications for accessories given in the technical appendix must be followed.

Width/Length/height with TS32x7.5 mm
 max. current / max. cond. cross-section A/mm²
 Max. clamping range mm²

Technical data

Rated data	
Rated voltage	V
Rated current	A
Rated cross-section	mm ²
Rated impulse voltage / Pollution severity	kV/-
Gauge to IEC 60947-1 / UL94 Flammability class	Approvals
Clamped conductors (H05V/H07V)	
solid / stranded	mm ²
flexible / Stranded wire with end ferrules	mm ²
Tightening torque range (clamping screw)	
Stripping length / Blade size	mm/-

Note

Ordering data

Version	
	Without socket
	With open rear wall for cross-connection
	With 2 sockets
	With 4 sockets

Note

Accessories

Screwable cross-connection	
	2-pole
	3-pole
	4-pole
	10-pole
	Connecting sleeve
	Mounting screw

End plate / Partition plate	
	Medium yellow
	beige
	Medium yellow

Small partition	
	Small partition

Cross-connection slider	
	2-pole
	3-pole
	4-pole
	Connecting sleeve for QVS
	Mounting screw for QVS

Testing / Checking	
	Test plug
	Socket

Miscellaneous accessories	
	Lockout device
	Short-circuit plug, 2-pole

Marking systems	
	(see assortment in catalogue 7)
	Marking tags

For detailed information on other accessories and applications, refer to the „Accessories“ section

SAKA 10

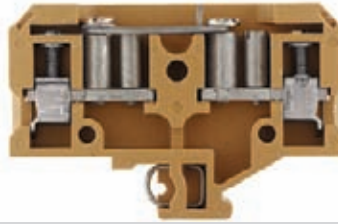
10 mm²

12 x 82 x 55.5

47 / 10

0.5...10

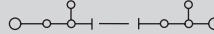

IEC 60947-7-1

IEC	UL	CSA
500		600
47		35
10		AWG 18...8
	6 / 3	
	B6 / 5VA	



Rated connection

0.5...10 / 1.5...10

0.5...10 / 0.5...10

1.2...2.4 Nm (M 4)

12 / 1.0 x 5.5 mm

10 mm² stranded can be connected with 2 Nm tightening torque.

Type	Qty.	Order No.
SAKA 10	25	0134120000

SAKB 10

10 mm²

10 x 65 x 52.5

57 / 10

0.5...10

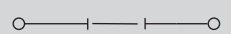

IEC 60947-7-1

IEC	UL	CSA
500		600
57		45
10		AWG 18...8
	6 / 3	
	B6 / 5VA	



Rated connection

0.5...10 / 1.5...10

0.5...10 / 0.5...10

1.2...2.4 Nm (M 4)

12 / 1.0 x 5.5 mm

10 mm² stranded can be connected with 2 Nm tightening torque.

Type	Qty.	Order No.
SAKB 10	50	0134920000

Type	current	Qty.	Order No.
QL 2 SAKB10	47 A	100	0114100000
QL 3 SAKB10	47 A	50	0114300000
QL 4 SAKB10	47 A	50	0114500000
QL 10 SAKB10	47 A	20	0338400000

Type	current	Qty.	Order No.
BFSC M4X30		50	0267100000
BFSC M4X9T		100	0103300000

Type	Width	Qty.	Order No.
AP SAKA KRG	3 mm	20	0134220000
TW SAK2.5-35/32 KRG	3 mm	10	0257120000
AP SAKB/C/T KRG	3 mm	20	0146720000
TW SAKB-C-T	3 mm	20	0242920000

Type	current	Qty.	Order No.
PS 4 F.STB 4	7.6 mm	20	0299600000
STB 13.5/D6/4/M4 SAKA10		50	0135200000
PS 4 F.STB 4	7.6 mm	20	0299600000
STB 16/D7/4/M4 SAK35		50	0140200000

Type	current	Qty.	Order No.
PS 4 F.STB 4	7.6 mm	20	0299600000
STB 13.5/D6/4/M4 SAKA10		50	0135200000
PS 4 F.STB 4	7.6 mm	20	0299600000
STB 16/D7/4/M4 SAK35		50	0140200000

Type	current	Qty.	Order No.
PS 4 F.STB 4	7.6 mm	20	0299600000
STB 13.5/D6/4/M4 SAKA10		50	0135200000
PS 4 F.STB 4	7.6 mm	20	0299600000
STB 16/D7/4/M4 SAK35		50	0140200000

Type	current	Qty.	Order No.
PS 4 F.STB 4	7.6 mm	20	0299600000
STB 13.5/D6/4/M4 SAKA10		50	0135200000
PS 4 F.STB 4	7.6 mm	20	0299600000
STB 16/D7/4/M4 SAK35		50	0140200000

Type	current	Qty.	Order No.
DEK 5/5			
DEK 5/5			

For detailed information on other accessories and applications, refer to the „Accessories“ section

SAKT 1/LT

6 mm²



8 x 65 x 52.5
57 / 10
0.13...10

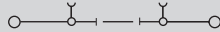

IEC 60947-7-1

IEC	UL	CSA
400	300	300
41	25	25
6	AWG 22...8	AWG 26...8
6 / 3		
A5 / 5VA		



Rated connection

0.5...10 / 1.5...10
 0.5...6 / 0.5...6
 0.8...1.6 Nm (M 3.5)
 12 / 4.0 x 0.8 mm

10 mm² stranded and AWG 8/7 connections are to be fixed with 1.6 Nm tightening torque.

Type	Qty.	Order No.
SAKT 1/LT	50	0269120000
SAKT 1/LT STB14/4	50	0437920000

Type	current	Qty.	Order No.
QL 2 SAK6N	57 A	50	0194300000
QL 3 SAK6N	57 A	50	0194400000
QL 4 SAK6N	57 A	50	0194500000
QL 10 SAK6N	57 A	20	0338300000
VH 12/4.9/3.3 SAK6N		100	0249000000
KISC M3X20 SAK10 CU5		100	0377100000
Width			
AP SAKB/C/T KRG	3 mm	20	0146720000
TW SAKB/C/T1	1.5 mm	20	0242960000
current			
TSCH 2	0.6 mm	100	0353660000
current			
QVS 2 SAKT1+2		20	0307300000
QVS 3 SAKT1+2		20	0329300000
QVS 4 SAKT1+2		20	0307400000
VH 19/6/4.2 SAKT1		50	0318000000
BS 25 O.IH SAKT1		50	0334700000
Width			
PS 4 F.STB 4	7.6 mm	20	0299600000
STB 14/D6/4/M3 SAK10		50	0169900000
SSP 3 SAKT1		100	0531760000
QS 2/8/4		20	0270960000

DEK 5/6,5

To safe the test sockets use the SDIZ-blade (see chapter Tools) or bits with pilots!

SAKT 1/DU1

6 mm²

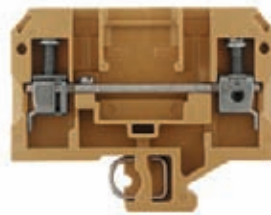

8 x 65 x 52.5
57 / 10
0.13...10

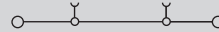

IEC 60947-7-1

IEC	UL	CSA
400	300	300
41	25	25
6	AWG 22...8	AWG 26...8
6 / 3		
A5 / 5VA		



Rated connection

0.5...10 / 1.5...10
 0.5...6 / 0.5...6
 0.8...1.6 Nm (M 3.5)
 12 / 4.0 x 0.8 mm

10 mm² stranded and AWG 8/7 connections are to be fixed with 1.6 Nm tightening torque.

Type	Qty.	Order No.
SAKT 1/DU2	50	0550420000
SAKT 1/DU1	50	0195620000

Type	current	Qty.	Order No.
QL 2 SAK6N	57 A	50	0194300000
QL 3 SAK6N	57 A	50	0194400000
QL 4 SAK6N	57 A	50	0194500000
QL 10 SAK6N	57 A	20	0338300000
VH 12/4.9/3.3 SAK6N		100	0249000000
KISC M3X20 SAK10 CU5		100	0377100000
Width			
AP SAKB/C/T KRG	3 mm	20	0146720000
TW SAKB/C/T1	1.5 mm	20	0242960000
current			
TSCH 2	0.6 mm	100	0353660000
current			
QVS 2 SAKT1+2		20	0307300000
QVS 3 SAKT1+2		20	0329300000
QVS 4 SAKT1+2		20	0307400000
VH 19/6/4.2 SAKT1		50	0318000000
BS 25 O.IH SAKT1		50	0334700000
Width			
PS 4 F.STB 4	7.6 mm	20	0299600000
STB 14/D6/4/M3 SAK10		50	0169900000
SSP 3 SAKT1		100	0531760000
QS 2/8/4		20	0270960000

DEK 5/6,5

To safe the test sockets use the SDIZ-blade (see chapter Tools) or bits with pilots!

SAKT 1/QT

6 mm²



8 x 65 x 52.5
57 / 10
0.13...10

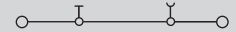

IEC 60947-7-1

IEC	UL	CSA
400	300	300
41	25	25
6	AWG 22...8	AWG 26...8
6 / 3		
A5 / 5VA		



Rated connection

0.5...10 / 1.5...10
 0.5...6 / 0.5...6
 0.8...1.6 Nm (M 3.5)
 12 / 4.0 x 0.8 mm

10 mm² stranded and AWG 8/7 connections are to be fixed with 1.6 Nm tightening torque.

Type	Qty.	Order No.
SAKT 1/QT2	50	0494820000
SAKT 1/QT1	50	0269320000

Type	current	Qty.	Order No.
QL 2 SAK6N	32 A	50	0194300000
QL 3 SAK6N	57 A	50	0194400000
QL 4 SAK6N	57 A	50	0194500000
QL 10 SAK6N	32 A	20	0338300000
VH 12/4.9/3.3 SAK6N		100	0249000000
KISC M3X20 SAK10 CU5		100	0377100000
Width			
AP SAKB/C/T KRG	3 mm	20	0146720000
TW SAKB/C/T1	1.5 mm	20	0242960000
current			
TSCH 2	0.6 mm	100	0353660000
current			
QVS 2 SAKT1+2	41 A	20	0307300000
QVS 3 SAKT1+2	41 A	20	0329300000
QVS 4 SAKT1+2	41 A	20	0307400000
VH 19/6/4.2 SAKT1		50	0318000000
BS 25 O.IH SAKT1		50	0334700000
Width			
PS 4 F.STB 4	7.6 mm	20	0299600000
STB 14/D6/4/M3 SAK10		50	0169900000
SSP 3 SAKT1		100	0531760000
QS 2/8/4		20	0270960000

DEK 5/6,5

To safe the test sockets use the SDIZ-blade (see chapter Tools) or bits with pilots!

Test-disconnect terminals

TS 32 / KrG

In hazardous area applications, the installation instructions and the rated data specifications for accessories given in the technical appendix must be followed.

Width/Length/height with TS32x7.5	mm
max. current / max. cond. cross-section	A/mm ²
Max. clamping range	mm ²

Technical data

Rated data	
Rated voltage	V
Rated current	A
Rated cross-section	mm ²
Rated impulse voltage / Pollution severity	kV/-
Gauge to IEC 60947-1 / UL94 Flammability class	
Approvals	
Clamped conductors (H05V/H07V)	
solid / stranded	mm ²
flexible / Stranded wire with end ferrules	mm ²
Tightening torque (clamping screw)	
Stripping length / Blade size	mm/-
Note	

Ordering data

Version	
	Without socket
	With open rear wall for cross-connection
	With 2 sockets
	With 4 sockets
Note	

Accessories

Screwable cross-connection	
	2-pole
	3-pole
	4-pole
	10-pole
	Connecting sleeve
	Mounting screw
End plate / Partition plate	
	Medium yellow
	beige
	Medium yellow
Small partition	
	Small partition
Cross-connection slider	
	2-pole
	3-pole
	4-pole
	Connecting sleeve for QVS
	Mounting screw for QVS
Testing / Checking	
	Test plug
	Socket
Miscellaneous accessories	
	Lockout device
	Short-circuit plug, 2-pole
Marking systems	
	(see assortment in catalogue 7)
	Marking tags
For detailed information on other accessories and applications, refer to the „Accessories“ section	

SAKT 2/LT

6 mm²

8 x 82 x 52.5	
46 / 10	
0.5...10	

IEC 60947-7-1

IEC	UL	CSA
125	300	
41	25	
6	AWG 22...8	
	6 / 3	
	A5 / 5VA	



Rated connection

0.5...10 / 1.5...10
0.5...6 / 0.5...6
1.2...1.6 Nm (M 3.5)
12 / 4.0 x 0.8 mm

10 mm² stranded and AWG 8/7 connections are to be fixed with 1.6 Nm tightening torque.

Type	Qty.	Order No.
SAKT 2/LT O.STB	50	0445420000
SAKT 2/LT STB	50	0330620000
SAKT 2/LT 4STB	50	0437720000

Type	current	Qty.	Order No.
QL 2 SAK6N	32 A	50	0194300000
QL 3 SAK6N	57 A	50	0194400000
QL 4 SAK6N	57 A	50	0194500000
QL 10 SAK6N	32 A	20	0338300000
VH 12/4.9/3.3 SAK6N		100	0249000000
KISC M3X20 SAK10 CU5		100	0377100000
Width			
AP SAKB/C/T KRG	3 mm	20	0146720000
TW SAKB/C/T1	1.5 mm	20	0242960000
TSCH 2			
	0.6 mm	100	0353660000
current			
QVS 2 SAKT1+2	41 A	20	0307300000
QVS 3 SAKT1+2	41 A	20	0329300000
QVS 4 SAKT1+2	41 A	20	0307400000
VH 19/6/4.2 SAKT1		50	0318000000
BS 25 O.IH SAKT1		50	0334700000
Width			
PS 4 F.STB 4	7.6 mm	20	0299600000
STB 14/D6/4/M3 SAK10		50	0169900000
SSP 3 SAKT1			
		100	0531760000
QS 2/8/4			
		20	0270960000

DEK 5/6,5

To safe the test sockets use the SDIZ-blade (see chapter Tools) or bits with pilots!

SAKT 4/LT

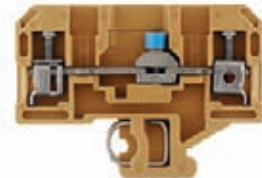
4 mm²

8 x 57.2 x 42.5	
41 / 6	
0.13...6	

IEC 60947-7-1

IEC	UL	CSA
400	300	300
32	20	20
4	AWG 22...12	AWG 26...10
	6 / 3	
	A3 / 5VA	



Rated connection

0.5...6 / 1.5...4
0.5...4 / 0.5...4
0.4...0.7 Nm (M 2.5)
10 / 0.6 x 3.5 mm

Two conductors with the same cross-section can be accommodated. 1.5 mm² solid and 0.5...1.5 mm² flexible

Type	Qty.	Order No.
SAKT 4/LT O.STB	50	0254120000
SAKT 4/LT STB2.0	50	0310320000

Type	current	Qty.	Order No.
QL 2 SAK2.5	41 A	100	0155900000
QL 3 SAK2.5	41 A	100	0156000000
QL 4 SAK2.5	41 A	50	0156100000
QL 10 SAK2.5	41 A	20	0338100000
VH 8/4.9/3.3 SAK2.5		100	0266700000
KISC M3X15/6 SAK2.5 CU5		100	0377200000
Width			
TW AST1/PA HP/DBR/0.5	0.5 mm	20	0474700000
current			
QVS 2/4 SAKT4	32 A	20	1319260000
Width			
VH 16/5/3.5 SAK10-35		50	0309700000
BFSC M3X22 SAKT4		50	1319900000
Width			
PS 2.3 RT	5.4 mm	20	0180400000
STB 8.5/5/2.3/M3 SAK2.5		50	0280600000
SSP 4 SAKT4			
		20	1319360000

DEK 5/6,5

To safe the test sockets use the SDIZ-blade (see chapter Tools) or bits with pilots!

Terminals for temperature measuring circuits

TS 32 / PA

Busbars from thermocouple materials, according to DIN IEC 584.

In hazardous area applications, the installation instructions and the rated data specifications for accessories given in the technical appendix must be followed.

Width/Length/height with TS32x7.5	mm
max. current / max. cond. cross-section	A/mm ²
Max. clamping range	mm ²

Technical data**Rated data**

Rated voltage	V
Rated current	A
Rated cross-section	mm ²
Rated impulse voltage / Pollution severity	kV/-
Gauge to IEC 60947-1 / UL94 Flammability class	
Approvals	

Clamped conductors (H05V/H07V)

solid / stranded	mm ²
flexible / Stranded wire with end ferrules	mm ²
Tightening torque range (clamping screw)	
Stripping length / Blade size	mm/-

Note**Ordering data****Version**

NiCr	
Ni	
CuNi	
Fe	
Cu	
(NiCr - Ni) type K	
(Cu - CuNi) type T	
(Fe-CuNi) type J	

Note**Accessories****End plate / Partition plate**

beige	
beige	
Dark beige Wemid	

Marking systems (see assortment in catalogue 7)

Marking tags

For detailed information on other accessories and applications, refer to the „Accessories“ section

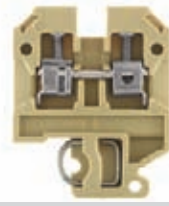
SAK 2.5/TC**2.5 mm²**

6 x 36.5 x 46.5

/ 2.5

...2.5

IEC 60947-7-1 / IEC 60584

IEC	UL	CSA
-----	----	-----

2.5

/ 3

/ V2

**Rated connection**

0.5...2.5

0.4...0.6 Nm (M 2.5)

10 / 0.6 x 3.5 mm

DK 4 TC**4 mm²**

6 x 54 x 59.5

/ 4

...4

IEC 60947-7-1 / IEC 60584

IEC	UL	CSA
-----	----	-----

4

/ 3

/ V2

**Rated connection**

0.5...4 / 1.5...4

0.5...4 / 0.5...2.5

0.5...1.0 Nm (M 3)

9 / 0.6 x 3.5 mm

Ordering data**Type**

Type	Qty.	Order No.
SAK 2.5/TC CH	100	0107260000
SAK 2.5/TC AL	100	0107160000
SAK 2.5/TC CO	100	0189860000
SAK 2.5/TC FE	100	0190060000
SAK 2.5/TC CU	100	0189960000
DK 4Q/TC TYP K	100	1338260000
DK 4Q/TC TYP T	100	1338160000
DK 4Q/TC TYP J	100	1338060000

Note**Type**

Type	Width	Qty.	Order No.
AP SAK2.5	1.5 mm	20	0279560000
TW SAK2.5	2.5 mm	20	0302860000
AP DK4Q	1.5 mm	20	1397160000
TW SAKS2 HP/DBR/2	2 mm	20	0607000000
WTW EN	3 mm	20	1058800000

Marking systems (see assortment in catalogue 7)

DEK 5/6 / SCHT 7

DEK 5/6

SAK 2.5/TC / DK 4 TC

Weidmüller thermocouple terminals are specially designed for the transmission of very small voltages in temperature measuring circuits. Special current bars ensure that no false signals are transmitted within the terminal when temperature differences between the positive and negative paths exist. This high measuring precision is required, for example, in aircraft engine test rigs, complicated chemical processes, controllers, etc.

- Material of current bar corresponds to thermal and compensating conductors
- Clear thermocouple marking
- 2-pole blocks per thermocouple
- Modular width 10 mm

Configuration of a temperature measuring circuit

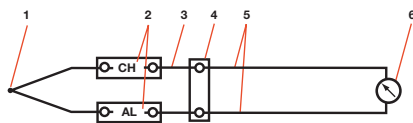

- 1 Thermocouple (sensor)
- 2 Thermocouple terminals
- 3 Compensating conductor
- 4 Reference junction
- 5 Supply and return conductors
- 6 Measuring instrument

The thermocouple terminals shown in this measuring circuit are used for the thermoelectrical transmission of the thermoelectric voltage from the thermocouple to the reference junction and the indicator unit via the compensating conductor. Thermocouple terminals are required for constructing a temperature measuring circuit.

Technical data

Thermocouples to IEC 584 (DIN 43 710)

Terminal	Busbar material trade name
a) Type J	
Fe (positive leg)	Iron
CuNi (negative leg)	Constantan
b) Type T	
Cu (positive leg)	Copper
CuNi (negative leg)	Constantan
c) Type K	
NiCr (positive leg)	Chromel
Ni (negative leg)	Alumel

Terminals with screw-less connections

with push-on connection
TS 32 / PA

In hazardous area applications, the installation instructions and the rated data specifications for accessories given in the technical appendix must be followed.

Width/Length/height with TS32x7.5	mm
max. current / max. cond. cross-section	A/mm ²
Max. clamping range	mm ²

Technical data

Rated data	
Rated voltage	V
Rated current	A
Rated cross-section	mm ²
Rated impulse voltage / Pollution severity	kV/-
Gauge to IEC 60947-1 / UL94 Flammability class	
Approvals	
Clamped conductors (H05V/H07V)	
solid / stranded	mm ²
flexible / Stranded wire with end ferrules	mm ²
Tightening torque range (clamping screw)	
Stripping length / Blade size	mm/-
Note	

Ordering data

Version	
	Slotted
	Not slit
Note	

Accessories

Screwable cross-connection	
	2-pole
	3-pole
	4-pole
	10-pole
Plug-in adapter	
	2-pole
	3-pole
	4-pole
	5-pole
	8-pole
End plate / Partition plate	
	beige
	beige
Small partition	
	Small partition
Testing / Checking	
	Test plug
	Socket
Insulating sleeve	
	2,8
	6,3
Marking systems	
	(see assortment in catalogue 7)
	Marking tags
For detailed information on other accessories and applications, refer to the „Accessories“ section	

AST 1

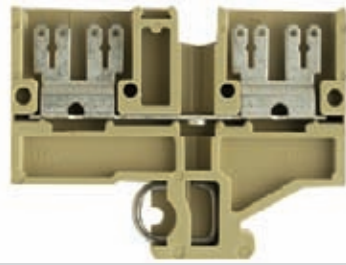
2.5 mm²

6.5 x 58 x 46	F6.3 F6.3	F2.8 F2.8	F6.3 F6.3	F2.8 F2.8
20 / 2.5				
0.5...2.5				

IEC 60947-7-1 / IEC 61210

IEC	UL	CSA
500	600	300
20	13	16
2.5		
	6 / 3	
	/ V2	
Rated connection		
0.5...2.5		
Note		
Cable-lug connections should be fitted with insulating sleeves. 20 A with F 6.3 or 2 x F 2.8		

Type	Qty.	Order No.
AST 1 6.3/2.8	50	0478260000
AST 1 6.3	50	0266360000

Type	current	Qty.	Order No.
Q 2 SAK4	41 A	50	0336700000
Q 3 SAK4	41 A	50	0336800000
Q 4 SAK4	41 A	50	0336900000
Q 10 SAK4	41 A	20	0368800000
Width			
STA 2.5/2		100	0165860000
STA 2.5/3		50	0165960000
STA 2.5/4		50	0190360000
STA 2.5/5		50	0166060000
STA 2.5/8		50	0166160000
AP AST1+5 DB	1.5 mm	20	0266400000
TW AST1/PA HP/DBR/0.5	0.5 mm	20	0474700000
TSCH 1	2 mm	100	0319160000
PS 2.3 RT	5.4 mm	20	0180400000
STB 14/D5/2.3/M3 SAK2.5		50	0168600000
IH 2.8 DB		100	0386060000
IH 6.3 WEM GE		100	0386260000
Marking systems			
DEK 5/6,5			

AST 3

2.5 mm²

6.5 x 40 x 46	6.3 2.8	6.3 2.8
20 / 2.5		
0.5...2.5		

IEC 60947-7-1 / IEC 61210

IEC	UL	CSA
500	300	300
20	13	16
2.5		
	6 / 3	
	/ 5VA	
Rated connection		
0.5...2.5		
Note		
The rated voltage is 800 V when using a cable-lug (flat) connector with IH 6.3 insulating sleeves.		

Type	Qty.	Order No.
AST 3 6.3	100	0236760000

Cable-lug connections should be connected with insulating sleeves. 20 A with F 6.3 or 2 x F 2.8

Type	current	Qty.	Order No.
Q 2 SAK4	41 A	50	0336700000
Q 3 SAK4	41 A	50	0336800000
Q 4 SAK4	41 A	50	0336900000
Q 10 SAK4	41 A	20	0368800000
Width			
STA 2.5/2		100	0165860000
STA 2.5/3		50	0165960000
STA 2.5/4		50	0190360000
STA 2.5/5		50	0166060000
STA 2.5/8		50	0166160000
AP SAK2.5/35 + AST3+4	1.5 mm	20	0460560000
TW SAKS2 HP/DBR/2	2 mm	20	0607000000
TSCH 1	2 mm	100	0319160000
PS 2.3 RT	5.4 mm	20	0180400000
STB 14/D5/2.3/M3 SAK2.5		50	0168600000
IH 2.8 DB		100	0386060000
IH 6.3 WEM GE		100	0386260000
Marking systems			
DEK 5/6			

SAK 4 S

4 mm²



6.5 x 40 x 51.5
20 / 6
0.13...6

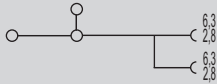

IEC 60947-7-1 / IEC 61210

IEC	UL	CSA
500	300	300
20	13	13
4	AWG 26...12	AWG 26...12
	6 / 3	
	A4 / V2	



Rated connection

0.33...6 / 1.5...4
 0.5...4 / 0.5...4
 0.5...1.0 Nm (M 3)
 12 / 0.6 x 3.5 mm

Cable-lug connections should be fitted with insulating sleeves. 20 A with F 6.3 or 2 x F 2.8

Type	Qty.	Order No.
SAK 4 S 6.3/2.8	100	0401260000

Type	current	Qty.	Order No.
QL 2 SAK4	32 A	100	0130600000
QL 3 SAK4	32 A	100	0130700000
QL 4 SAK4	32 A	50	0130800000
QL 10 SAK4	32 A	20	0338200000

Width			
AP SAK4-10	1.5 mm	20	0117960000
TW 4 SAK4-10	1.5 mm	20	0130160000

IH 2.8 DB	100	0386060000
IH 6.3 WEM GE	100	0386260000

DEK 5/6,5

SAK 4 SS

2.5 mm²



6.5 x 40 x 51.5
20 / 2.5
0.5...2.5

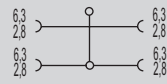

IEC 60947-7-1 / IEC 61210

IEC	UL	CSA
500	600	300
20	13	13
2.5	AWG 18...14	AWG 18...14
	6 / 3	
	/ V2	



Rated connection

0.5...2.5

Cable-lug connections should be fitted with insulating sleeves. 20 A with F 6.3 or 2 x F 2.8

Type	Qty.	Order No.
SAK 4 SS 6.3/2.8	100	0479660000

Type	current	Qty.	Order No.
QL 2 SAK4	32 A	100	0130600000
QL 3 SAK4	32 A	100	0130700000
QL 4 SAK4	32 A	50	0130800000
QL 10 SAK4	32 A	20	0338200000

Width			
AP SAK4-10	1.5 mm	20	0117960000
TW 4 SAK4-10	1.5 mm	20	0130160000

IH 2.8 DB	100	0386060000
IH 6.3 WEM GE	100	0386260000

DEK 5/6,5

DK 4 S

4 mm²



6 x 54 x 59.5
20 / 4
0.33...4



IEC 60947-7-1 / IEC 61210

IEC	UL	CSA
400	300	300
10	10	10
4	AWG 22...12	AWG 22...12
	6 / 3	
	A3 / V2	



Rated connection

0.5...4 / 1.5...4
 0.5...4 / 0.5...2.5
 0.5...0.8 Nm (M 3)
 8 / 0.6 x 3.5 mm

Cable-lug connections should be fitted with insulating sleeves. 20 A supplied via F 6.3 or 2 x F 2.8.

Type	Qty.	Order No.
DK 4S SF 6.3/2.8	100	0631260000

Type	current	Qty.	Order No.
Q 2 AKZ4	32 A	50	0336400000
Q 3 AKZ4	32 A	50	0336500000
Q 4 AKZ4	32 A	50	0336600000
Q 10 AKZ4	32 A	20	0368600000

Width			
AP DK4S		20	0631360000

TSCH 6 DK1 S4	5 mm	100	0190260000
PS 2.3 RT	5.4 mm	20	0180400000
STB 8.5/D4/2.3/M2.5 AKZ		50	0215700000

IH 2.8 DB	100	0386060000
IH 6.3 WEM GE	100	0386260000

DEK 5/6

Terminals with screw-less connections

with Termini-Point / Wire-Wrap connection TS 32 / PA

In hazardous area applications, the installation instructions and the rated data specifications for accessories given in the technical appendix must be followed.

Width/Length/height with TS32x7.5	mm
max. current / max. cond. cross-section	A/mm ²
Max. clamping range	mm ²

Technical data

Rated data

Rated voltage	V
Rated current	A
Rated cross-section	mm ²
Rated impulse voltage / Pollution severity	kV/-
Gauge to IEC 60947-1 / UL94 Flammability class	
Approvals	

Clamped conductors (H05V/H07V)

solid / stranded	mm ²
flexible / Stranded wire with end ferrules	mm ²
Tightening torque range (clamping screw)	
Stripping length / Blade size	mm/-

Note

Ordering data

Version

	right
--	-------

Note

Accessories

Screwable cross-connection



2-pole	
3-pole	
4-pole	
10-pole	

End plate / Partition plate

beige	
Blue	
beige	

Small partition

Small partition	
-----------------	--

External cross-connection

2-pole	
3-pole	
4-pole	

Testing / Checking

Test plug	
Socket	

Marking systems	(see assortment in catalogue 7)
	Marking tags

For detailed information on other accessories and applications, refer to the „Accessories“ section

SAK 2.5 T 1x1

2.5 mm²

6 x 36.5 x 67
8 / 6
0.33...6

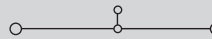

IEC 60947-7-1

IEC	UL	CSA
250		300
8		10
2.5		AWG 22...12
		4 / 3
		A3 / V2



Rated connection

0.5...6 / 0.5...2.5
0.5...4 / 0.5...2.5
0.4...0.7 Nm (M 2.5)
10 / 0.6 x 3.5 mm

DK 4 T

4 mm²

6 x 50 x 77.5
10 / 6
0.5...6



IEC 60947-7-1 / IEC 61210

IEC	UL	CSA
250	300	300
10	10	10
4	AWG 22...12	AWG 22...12
		4 / 3
		A3 / V2



Rated connection

0.5...6 / 1.5...4
0.5...4 / 0.5...2.5
0.5...0.8 Nm (M 3)
8 / 0.6 x 3.5 mm

Type	Qty.	Order No.
SAK 2.5 SW 1X1	100	0108560000

Type	Qty.	Order No.
DK 4 SW 1X1	50	0536560000

Type	current	Qty.	Order No.
Q 2 SAK2.5	41 A	50	0337000000
Q 3 SAK2.5	41 A	50	0337100000
Q 4 SAK2.5	41 A	50	0337200000
Q 10 SAK2.5	41 A	20	0368700000

	Width	Qty.	Order No.
AP SAK2.5	1.5 mm	20	0279560000
TW SAK2.5	2.5 mm	20	0302860000
TSCH 1	2 mm	100	0319160000

	current	Qty.	Order No.
QB 2 WI RA6 IS	27 A	50	0482700000
QB 3 WI RA6 IS	27 A	50	0482800000
QB 4 WI RA6 IS	27 A	50	0482900000

	Width	Qty.	Order No.
PS 2.3 RT	5.4 mm	20	0180400000
STB 8.5/5/2.3/M3 SAK2.5		50	0280600000

Type	current	Qty.	Order No.
Q 2 AKZ4	32 A	50	0336400000
Q 3 AKZ4	32 A	50	0336500000
Q 4 AKZ4	32 A	50	0336600000
Q 10 AKZ4	32 A	20	0368600000

	Width	Qty.	Order No.
AP DK4	1.5 mm	20	0359260000
AP DK4 BL	1.5 mm	20	0359280000
TW SAKS2 HP/DBR/2	2 mm	20	0607000000
TSCH 4 AKZ4	6 mm	100	0363360000

	current	Qty.	Order No.
QB 2 WI RA6 IS	27 A	50	0482700000
QB 3 WI RA6 IS	27 A	50	0482800000
QB 4 WI RA6 IS	27 A	50	0482900000

	Width	Qty.	Order No.
PS 2.3 RT	5.4 mm	20	0180400000
STB 8.5/D4/2.3/M2.5 AKZ		50	0215700000

Marking systems	(see assortment in catalogue 7)
	DEK 5/6

For detailed information on other accessories and applications, refer to the „Accessories“ section

with solder connection
TS 32 / PA

In hazardous area applications, the installation instructions and the rated data specifications for accessories given in the technical appendix must be followed.

Width/Length/height with TS32x7.5	mm
max. current / max. cond. cross-section	A/mm ²
Max. clamping range	mm ²

Technical data

Rated data	
Rated voltage	V
Rated current	A
Rated cross-section	mm ²
Rated impulse voltage / Pollution severity	kV/-
Gauge to IEC 60947-1 / UL94 Flammability class	
Approvals	
Clamped conductors (H05V/H07V)	
solid / stranded	mm ²
flexible / Stranded wire with end ferrules	mm ²
Tightening torque range (clamping screw)	
Stripping length / Blade size	mm/-
Note	

Ordering data

Version	
	beige
	right
	left
Note	

Accessories

Screwable cross-connection	
	2-pole
	3-pole
	4-pole
	10-pole
External cross-connection	
	2-pole
	3-pole
	4-pole
End plate / Partition plate	
	beige
	Blue
	beige
	Blue
Small partition	
	Small partition
Cover / warning label	
	Cover / warning label
	Mounting screw (plastic)
Testing / Checking	
	Test plug
	Socket

Marking systems	
	(see assortment in catalogue 7)
	Marking tags
For detailed information on other accessories and applications, refer to the „Accessories“ section	

SAKRT

4 mm²



6.5 x 42 x 40.5
8 / 4
0.5...4

IEC 60947-7-1		
IEC	UL	CSA
250		300
8		10
4		AWG 22...12
		4 / 3
		A3 / V2
Rated connection		
0.5...4 / 1.5...4		
0.5...4 / 0.5...2.5		
0.5...1.0 Nm (M 3)		
8 / 0.6 x 3.5 mm		
QB 25 blank, refer to „Accessories“ section. Note that max. conductor connection with QB = 2.5 mm ² . Twin wire-end ferrules ZH 0.5 - ZH 1.5 can be used.		

Type	Qty.	Order No.
SAKR TS SE 1.6	100	0469360000

Type	current	Qty.	Order No.
QB 2 WI RA6 IS	27 A	50	0482700000
QB 3 WI RA6 IS	27 A	50	0482800000
QB 4 WI RA6 IS	27 A	50	0482900000
Width			
AP SAKR BE	1.5 mm	20	0211360000
TW SAKS2 HP/DBR/2	2 mm	20	0607000000
PS 2.3 RT	5.4 mm	20	0180400000

Type	Qty.	Order No.
DEK 5/6,5		

SAK 2.5 L

2.5 mm²

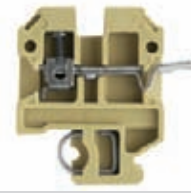

6 x 44.5 x 46.5
17.5 / 6
0.33...6

IEC 60947-7-1 / IEC 60068-2-20		
IEC	UL	CSA
250		300
17.5		10
2.5		AWG 22...12
		4 / 3
		A3 / V2
Rated connection		
0.5...6 / 0.5...2.5		
0.5...4 / 0.5...2.5		
0.4...0.7 Nm (M 2.5)		
10 / 0.6 x 3.5 mm		
max 1.5 mm ² conductor via solder connection		

Type	Qty.	Order No.
SAK 2.5 SL	100	0351460000

Type	current	Qty.	Order No.
Q 2 SAK2.5	41 A	50	0337000000
Q 3 SAK2.5	41 A	50	0337100000
Q 4 SAK2.5	41 A	50	0337200000
Q 10 SAK2.5	41 A	20	0368700000
Width			
AP SAK2.5	1.5 mm	20	0279560000
AP SAK2.5 BL	1.5 mm	20	0279580000
TW SAK2.5	2.5 mm	20	0302860000
TW SAK2.5 BL	1.5 mm	20	0302880000
TSCH 1	2 mm	100	0319160000
AD 4 AKZ4		50	0303400000
BFSC M3X22 PA/RT		100	0128900000
PS 2.3 RT	5.4 mm	20	0180400000
STB 8.5/5/2.3/M3 SAK2.5		50	0280600000

Type	Qty.	Order No.
DEK 5/6		

Terminals with screw-less connections

with solder connection
TS 32 / PA

SAKR L STB 6

4 mm²

SAKR LL

1.5 mm²

In hazardous area applications, the installation instructions and the rated data specifications for accessories given in the technical appendix must be followed.

Width/Length/height with TS32x7.5	mm
max. current / max. cond. cross-section	A/mm ²
Max. clamping range	mm ²

6.5 x 50 x 40.5	
10 / 4	
0.5...4	

6.5 x 58 x 40.5	
10 / 1.5	
0.5...1.5	



Technical data

Rated data	
Rated voltage	V
Rated current	A
Rated cross-section	mm ²
Rated impulse voltage / Pollution severity	kV/-
Gauge to IEC 60947-1 / UL94 Flammability class	
Approvals	
Clamped conductors (H05V/H07V)	
solid / stranded	mm ²
flexible / Stranded wire with end ferrules	mm ²
Tightening torque range (clamping screw)	
Stripping length / Blade size	mm/-
Note	

IEC 60947-7-1 / IEC 60068-2-20

IEC	UL	CSA
250		
10		
4		
	4 / 3	
	A3 / V2	

Rated connection

0.5...4 / 1.5...4
0.5...4 / 0.5...2.5
0.5...1.0 Nm (M 3)
8 / 0.6 x 3.5 mm

Note

When using disconnect terminals with sockets, the tightening torque is 0.5 - 0.7 Nm.

IEC 60947-7-1 / IEC 60068-2-20

IEC	UL	CSA
250		300
10		10
1.5		AWG 22...12
	4 / 3	
	/ V2	

Rated connection

0.5...1.5
0.5...1.5

Ordering data

Version	
	beige
	right
	left
Note	

Type	Qty.	Order No.
SAKR LS 2STB	100	0518160000

Type	Qty.	Order No.
SAKR LL	100	0464460000

Accessories

Screwable cross-connection	
	2-pole
	3-pole
	4-pole
	10-pole
External cross-connection	
	2-pole
	3-pole
	4-pole
End plate / Partition plate	
	beige
	Blue
	beige
	Blue
Small partition	
	Small partition
Cover / warning label	
	Cover / warning label
	Mounting screw (plastic)
Testing / Checking	
	Test plug
	Socket

Type	Qty.	Order No.
current		
QB 2 WI RA6 IS	27 A	50 0482700000
QB 3 WI RA6 IS	27 A	50 0482800000
QB 4 WI RA6 IS	27 A	50 0482900000
Width		
AP SAKR BE	1.5 mm	20 0211360000
AP SAKR BL	1.5 mm	20 0211380000
TW SAKS2 HP/DBR/2	2 mm	20 0607000000
Width		
AP SAKR BE	1.5 mm	20 0211360000
AP SAKR BL	1.5 mm	20 0211380000
TW SAKS2 HP/DBR/2	2 mm	20 0607000000
PS 2.3 RT	5.4 mm	20 0180400000
STB 6/D3.7/2.3/M3 SAKR		100 0379400000

Type	Qty.	Order No.
Width		
AP SAKR BE	1.5 mm	20 0211360000
AP SAKR BL	1.5 mm	20 0211380000
TW SAKS2 HP/DBR/2	2 mm	20 0607000000

Marking systems	(see assortment in catalogue 7)
	Marking tags
For detailed information on other accessories and applications, refer to the „Accessories“ section	

	DEK 5/6,5
	QB 25 blank, refer to „Accessories“ section. Note that max. conductor connection with QB = 2.5 mm ² . Twin wire-end ferrules ZH 0.5 - ZH 1.5 can be used.

	DEK 5/6,5
--	-----------

SAKR LL mit STB 6

1.5 mm²



6.5 x 58 x 40.5

10 / 1.5

0.33...1.5



IEC 60947-7-1 / IEC 60068-2-20

IEC	UL	CSA
250		300
10		10
1.5		AWG 22...12
	4 / 3	
	/ V2	



Rated connection

0.5...1.5

0.5...1.5

/ 0.6 x 3.5 mm

Tightening torque via the socket is 0.5 - 0.7 Nm.

Type	Qty.	Order No.
SAKR LL 2STB	100	0294260000

Type	Qty.	Order No.
Width		
AP SAKR BE	1.5 mm	20 0211360000
AP SAKR BL	1.5 mm	20 0211380000
TW AST1/PA HP/DBR/0.5	0.5 mm	20 0474700000
PS 2.3 RT	5.4 mm	20 0180400000

DEK 5/6,5

Terminals with screw-less connections

with push-on connection
TS 32 / KrG

In hazardous area applications, the installation instructions and the rated data specifications for accessories given in the technical appendix must be followed.

Width/Length/height with TS32x7.5	mm
max. current / max. cond. cross-section	A/mm ²
Max. clamping range	mm ²

Technical data

Rated data	
Rated voltage	V
Rated current	A
Rated cross-section	mm ²
Rated impulse voltage / Pollution severity	kV/-
Gauge to IEC 60947-1 / UL94 Flammability class	
Approvals	
Clamped conductors (H05V/H07V)	
solid / stranded	mm ²
flexible / Stranded wire with end ferrules	mm ²
Tightening torque range (clamping screw)	
Stripping length / Blade size	mm/-
Note	

Ordering data

Version	
	Slotted
	Not slit
Note	

Accessories

Screwable cross-connection	
	2-pole
	3-pole
	4-pole
	10-pole
Plug-in adapter	
	2-pole
	3-pole
	4-pole
	5-pole
	8-pole
End plate / Partition plate	
	beige
	Medium yellow
	Blue
	beige
	Medium yellow
	Blue
Small partition	
	Small partition
Testing / Checking	
	Test plug
	Socket
Insulating sleeve	
	2,8
	6,3
Marking systems	
	(see assortment in catalogue 7)
	Marking tags
For detailed information on other accessories and applications, refer to the „Accessories“ section	

AST 1

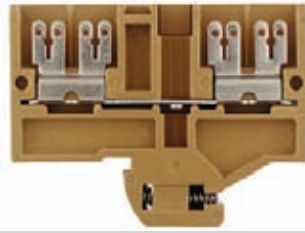
2.5 mm²

6.5 x 58 x 46	6.3	6.3	6.3	6.3
20 / 2.5	2.8	2.8	2.8	2.8
0.5...2.5				

IEC 60947-7-1 / IEC 61210

IEC	UL	CSA
500	600	300
20	13	16
2.5		
6 / 3		
/ 5VA		
		
Rated connection		
0.5...2.5		
Note		
Cable-lug connections should be fitted with insulating sleeves. 20 A with F 6.3 or 2 x F 2.8		

Type	Qty.	Order No.
AST 1 6.3/2.8 KRG	50	0478220000
AST 1 6.3 KRG	50	0266320000

Type	current	Qty.	Order No.
Q 2 SAK4	41 A	50	0336700000
Q 3 SAK4	41 A	50	0336800000
Q 4 SAK4	41 A	50	0336900000
Q 10 SAK4	41 A	20	0368800000
Width			
STA 2.5/2		100	0165860000
STA 2.5/3		50	0165960000
STA 2.5/4		50	0190360000
STA 2.5/5		50	0166060000
STA 2.5/8		50	0166160000
Width			
AP AST1+5 KRG	3 mm	20	0266420000
TW SAKS2 HP/DBR/2	2 mm	20	0607000000
Width			
TSCH 1	2 mm	100	0319160000
PS 2.3 RT	5.4 mm	20	0180400000
STB 14/D5/2.3/M3 SAK2.5	50		0168600000
Width			
IH 2.8 DB		100	0386060000
IH 6.3 WEM GE		100	0386260000
Width			
DEK 5/6,5			

AST 3

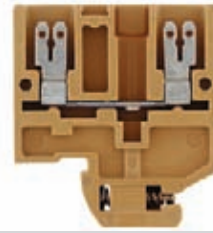
2.5 mm²

6.5 x 40 x 46	6.3	6.3
20 / 2.5	2.8	2.8
0.5...2.5		

IEC 60947-7-1 / IEC 61210

IEC	UL	CSA
500	300	300
20	13	16
2.5		
6 / 3		
/ 5VA		
		
Rated connection		
0.5...2.5		
Note		
The rated voltage is 800 V when using a cable-lug (flat) connector with IH 6.3 insulating sleeves.		

Type	Qty.	Order No.
AST 3 6.3/2.8 KRG	100	0442420000
AST 3 6.3 KRG	100	0298020000

Type	current	Qty.	Order No.
Q 2 SAK4	41 A	50	0336700000
Q 3 SAK4	41 A	50	0336800000
Q 4 SAK4	41 A	50	0336900000
Q 10 SAK4	41 A	20	0368800000
Width			
AP AST3+4 KRG	3 mm	20	0298120000
TW SAKS2 HP/DBR/2	2 mm	20	0607000000
Width			
TSCH 1	2 mm	100	0319160000
PS 2.3 RT	5.4 mm	20	0180400000
STB 14/D5/2.3/M3 SAK2.5	50		0168600000
Width			
IH 2.8 DB		100	0386060000
IH 6.3 WEM GE		100	0386260000
Width			
DEK 5/6			

AST 4

2.5 mm²



6.2 x 40 x 46
20 / 4
0.2...4

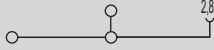

IEC 60947-7-1 / IEC 61210

IEC	UL	CSA
500	300	300
20	13	16
2.5	AWG 22...12	AWG 24...12
6 / 3		
A3 / 5VA		



Rated connection

0.5...4 / 1.5...2.5
0.5...2.5 / 0.5...2.5
0.4...0.7 Nm (M 2.5)
9 / 0.6 x 3.5 mm

Cable-lug connections should be fitted with insulating sleeves. 20 A with F 6.3 or 2 x F 2.8 When used with F 2.8, the rated voltage is 500 V

Type	Qty.	Order No.
AST 4 SF 6.3/2.8 KRG	100	0439120000

Type	current	Qty.	Order No.
Q 2 SAK4	41 A	50	0336700000
Q 3 SAK4	41 A	50	0336800000
Q 4 SAK4	41 A	50	0336900000
Q 10 SAK4	41 A	20	0368800000
Width			
STA 2.5/2		100	0165860000
STA 2.5/3		50	0165960000
STA 2.5/4		50	0190360000
STA 2.5/5		50	0166060000
STA 2.5/8		50	0166160000
Width			
AP AST3+4 KRG	3 mm	20	0298120000
TW SAKS2 HP/DBR/2	2 mm	20	0607000000
Width			
TSCH 1	2 mm	100	0319160000
Width			
PS 2.3 RT	5.4 mm	20	0180400000
STB 14/D5/2.3/M3 SAK2.5		50	0168600000
Width			
IH 2.8 DB		100	0386060000
IH 6.3 WEM GE		100	0386260000

DEK 5/6

AST 5

4 mm²

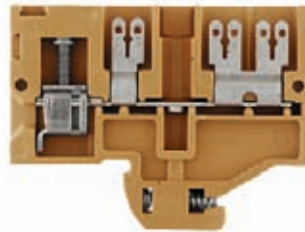

6.5 x 58 x 46
20 / 6
0.2...6

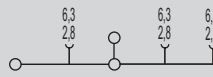

IEC 60947-7-1 / IEC 61210

IEC	UL	CSA
500	300	300
20	13	16
4	AWG 22...12	AWG 24...12
6 / 3		
A4 / 5VA		



Rated connection

0.5...6 / 1.5...2.5
0.5...4 / 0.5...4
0.5...1.0 Nm (M 3)
12 / 0.6 x 3.5 mm

Cable-lug connections should be fitted with insulating sleeves. 20 A with F 6.3 or 2 x F 2.8

Type	Qty.	Order No.
AST 5 SF 6.3/2.8 KRG	50	0479220000
AST 5 SF 6.3 KRG	50	0334520000

Type	current	Qty.	Order No.
Q 2 SAK4	41 A	50	0336700000
Q 3 SAK4	41 A	50	0336800000
Q 4 SAK4	41 A	50	0336900000
Q 10 SAK4	41 A	20	0368800000
Width			
AP AST1+5 KRG	3 mm	20	0266420000
TW SAKS2 HP/DBR/2	2 mm	20	0607000000
Width			
TSCH 1	2 mm	100	0319160000
Width			
PS 2.3 RT	5.4 mm	20	0180400000
STB 14/D5/2.3/M3 SAK2.5		50	0168600000
Width			
IH 2.8 DB		100	0386060000
IH 6.3 WEM GE		100	0386260000

DEK 5/6.5

Terminals with screw-less connections

with push-on connection
TS 32 / KrG

In hazardous area applications, the installation instructions and the rated data specifications for accessories given in the technical appendix must be followed.

Width/Length/height with TS32x7.5	mm
max. current / max. cond. cross-section	A/mm ²
Max. clamping range	mm ²

Technical data

Rated data	
Rated voltage	V
Rated current	A
Rated cross-section	mm ²
Rated impulse voltage / Pollution severity	kV/-
Gauge to IEC 60947-1 / UL94 Flammability class	Approvals
Clamped conductors (H05V/H07V)	
solid / stranded	mm ²
flexible / Stranded wire with end ferrules	mm ²
Tightening torque range (clamping screw)	
Stripping length / Blade size	mm/-
Note	

Ordering data

Version	
	Slotted
	Not slit
Note	

Accessories

Screwable cross-connection	
	2-pole
	3-pole
	4-pole
	10-pole
Plug-in adapter	
	2-pole
	3-pole
	4-pole
	5-pole
	8-pole
End plate / Partition plate	
	beige
	Medium yellow
	Blue
	beige
	Medium yellow
	Blue
Small partition	
	Small partition
Testing / Checking	
	Test plug
	Socket
Insulating sleeve	
	2,8
	6,3
Marking systems	
	(see assortment in catalogue 7)
	Marking tags
For detailed information on other accessories and applications, refer to the „Accessories“ section	

SAK 4 S

4 mm²

6.5 x 40 x 51.5
20 / 6
0.13...6

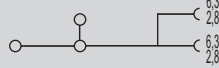

IEC 60947-7-1 / IEC 61210

IEC	UL	CSA
500	300	300
20	13	13
4	AWG 26...12	AWG 26...12
6 / 3		
A4 / 5VA		



Rated connection

0.33...6 / 1.5...4

0.5...4 / 0.5...4

0.5...1.0 Nm (M 3)

12 / 0.6 x 3.5 mm

Cable-lug connections should be fitted with insulating sleeves. 20 A with F 6.3 or 2 x F 2.8

Type	Qty.	Order No.
SAK 4 S 6.3/2.8/KRG	100	0401220000

Type	current	Qty.	Order No.
QL 2 SAK4	32 A	100	0130600000
QL 3 SAK4	32 A	100	0130700000
QL 4 SAK4	32 A	50	0130800000
QL 10 SAK4	32 A	20	0338200000

Width			
AP SAK4-10 KRG	1.5 mm	20	0117920000
AP SAK4-10 KRG/BL	1.5 mm	20	0117970000
TW SAK4-10 KRG	2.5 mm	20	0130120000
TW SAK4-10 KRG/BL	2.5 mm	20	0130170000

IH 2.8 DB	100	0386060000
IH 6.3 WEM GE	100	0386260000

DEK 5/6,5

SAK 4 SS

2.5 mm²

6.5 x 40 x 51.5
20 / 2.5
0.5...2.5

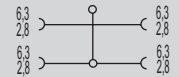

IEC 60947-7-1 / IEC 61210

IEC	UL	CSA
500	600	300
20	13	13
2.5	AWG 18...14	AWG 18...14
6 / 3		
/ 5VA		



Rated connection

0.5...2.5

Cable-lug connections should be fitted with insulating sleeves. 20 A with F 6.3 or 2 x F 2.8

Type	Qty.	Order No.
SAK 4 SS 6.3/2.8 KRG	100	0479620000
SAK 4 SS 6.3/KRG	100	0352920000

Type	current	Qty.	Order No.
QL 2 SAK4	32 A	100	0130600000
QL 3 SAK4	32 A	100	0130700000
QL 4 SAK4	32 A	50	0130800000
QL 10 SAK4	32 A	20	0338200000

Width			
AP SAK4-10	1.5 mm	20	0117960000
TW 4 SAK4-10	1.5 mm	20	0130160000

IH 2.8 DB	100	0386060000
IH 6.3 WEM GE	100	0386260000

DEK 5/6,5

with solder connection
TS 32 / KrG

SAK 2.5 L

2.5 mm²



In hazardous area applications, the installation instructions and the rated data specifications for accessories given in the technical appendix must be followed.

Width/Length/height with TS32x7.5	mm
max. current / max. cond. cross-section	A/mm ²
Max. clamping range	mm ²

6 x 44.5 x 46.5
17.5 / 6
0.33...6

Technical data

Rated data	
Rated voltage	V
Rated current	A
Rated cross-section	mm ²
Rated impulse voltage / Pollution severity	kV/-
Gauge to IEC 60947-1 / UL94 Flammability class	
Approvals	
Clamped conductors (H05V/H07V)	
solid / stranded	mm ²
flexible / Stranded wire with end ferrules	mm ²
Tightening torque range (clamping screw)	
Stripping length / Blade size	mm/-
Note	

IEC 60947-7-1 / IEC 60068-2-20

IEC	UL	CSA
250		300
17.5		10
2.5		AWG 22...12
		4 / 3
		A3 / 5VA

Ⓢ

Rated connection	
0.5...6 / 0.5...2.5	
0.5...4 / 0.5...2.5	
0.4...0.7 Nm (M 2.5)	
10 / 0.6 x 3.5 mm	

max 1.5 mm² conductor via solder connection

Ordering data

Version	
	Medium yellow
Note	

Type	Qty.	Order No.
SAK 2.5 LS KRG	100	0544120000

Accessories

Screwable cross-connection	
	2-pole
	3-pole
	4-pole
	10-pole
Testing / Checking	
	Test plug
	Socket
End plate	
	Medium yellow
	Blue
End plate / Partition plate	
	beige
Small partition	
	Small partition
Cover / warning label	
	Cover / warning label
	Mounting screw (plastic)

Type	current	Qty.	Order No.
Q 2 SAK2.5	41 A	50	0337000000
Q 3 SAK2.5	41 A	50	0337100000
Q 4 SAK2.5	41 A	50	0337200000
Q 10 SAK2.5	41 A	20	0368700000
Width			
PS 2.3 RT	5.4 mm	20	0180400000
STB 8.5/5/2.3/M3 SAK2.5		50	0280600000
AP SAK2.5L KRG	1.5 mm	20	0309220000
AP SAK2.5L KRG BL	1.5 mm	20	0309270000
TW SAKS2 HP/DBR/2	2 mm	20	0607000000
TSCH 1	2 mm	100	0319160000
AD 4 AKZ4		50	0303400000
BFSC M3X22 PA/RT		100	0128900000

Marking systems	
	(see assortment in catalogue 7)
	Marking tags
For detailed information on other accessories and applications, refer to the „Accessories“ section	

DEK 5/6

Special terminals - SAKG

TS 32 / KrG

In hazardous area applications, the installation instructions and the rated data specifications for accessories given in the technical appendix must be followed.

Width/Length/height with TS32x7.5	mm
max. current / max. cond. cross-section	A/mm ²
Max. clamping range	mm ²

Technical data

Rated data	
Rated voltage	V
Rated current	A
Rated cross-section	mm ²
Rated impulse voltage / Pollution severity	kV/-
Gauge to IEC 60947-1 / UL94 Flammability class	
Approvals	
Clamped conductors (H05V/H07V)	
solid / stranded	mm ²
flexible / Stranded wire with end ferrules	mm ²
Tightening torque range (clamping screw)	
Stripping length / Blade size	mm/-
Note	

Ordering data

Version	
	Medium yellow
Note	

Accessories

Screwable cross-connection	
	2-pole
	3-pole
	4-pole
End plate	
	dark brown
	Tropical applications
End plate / Partition plate	
	dark brown
	Tropical applications
Cover / warning label	
	Cover / warning label

Marking systems (see assortment in catalogue 7)
Marking tags

For detailed information on other accessories and applications, refer to the „Accessories“ section

SAKG 28 I

35 mm²

28 x 70 x 63.5

150 / 50

6...50



IEC 60947-7-1

IEC	UL	CSA
1000	600	600
125	95	110
35	AWG 6...2	AWG 6...1
8 / 3		
B9 / 5VA		

Rated connection

6...16 / 6...50
10...35 / 6...35
4.0...6.0 Nm (M 6)
15 /

Conductor connection with cable lugs according to DIN 46234 and DIN 46235, from 6 .. 50 mm²

Type	Qty.	Order No.
SAKG 28 I	10	0170020000

Type	current	Qty.	Order No.
QL 2 SAKG28		10	0551200000
QL 3 SAKG28		5	0407600000
QL 4 SAKG28		5	0407700000
Width			
EP 1 SAKG28/32 HP/DBR	2 mm	10	0205100000
EP 1 SAKG28/32 HP/TF/GE	2 mm	10	0205200000
TW SAKG28 HP/DBR/2	2 mm	10	0151400000
TW SAKG28 HP/TF/GE/2	2 mm	10	0164600000
AH 28 SAKG28	26 mm	5	0326660000

The Weidmüller SAKG range offers the following connection variants:

- Clamping yoke/flat lug as a combination, Version I.
- Flat lug, Version II.
Two types of threading are provided here.
a) screw set with lock nut
b) with thread in busbar
- Clamping yoke connection, Version III.
The stripped conductor can be connected without further preparation.

Versions



Version I

Version II
without threadVersion IIG
with thread

Version III

Cables with cable lugs are connected to SAKG terminals of Version I and to SS stud terminals.

Fitting instructions for SAKG terminals

When tightening the clamping screw, it is recommended that the conductor be held against the direction of tightening to prevent deformation of the mounting rail and so as not to place the terminal foot under undue torsional forces.

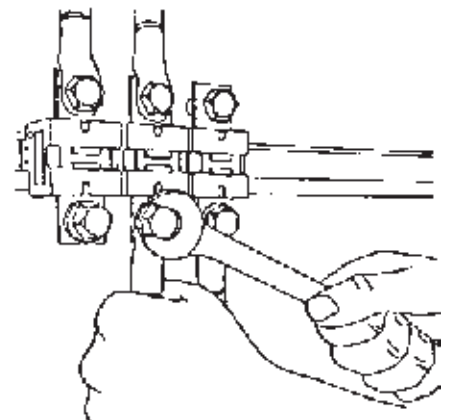

Cover

To ensure shock protection following connections of **conductors, AH** covers can be clipped onto the terminal.

TS 32 / KrG

In hazardous area applications, the installation instructions and the rated data specifications for accessories given in the technical appendix must be followed.

Width/Length/height with TS32x7.5	mm
max. current / max. cond. cross-section	A/mm ²
Max. clamping range	mm ²

Technical data

Rated data	
Rated voltage	V
Rated current	A
Rated cross-section	mm ²
Rated impulse voltage / Pollution severity	kV/-
Gauge to IEC 60947-1 / UL94 Flammability class	Approvals
Clamped conductors (H05V/H07V)	
solid / stranded	mm ²
flexible / Stranded wire with end ferrules	mm ²
Tightening torque range (clamping screw)	
Stripping length / Blade size	mm/-
Note	

Ordering data

Version	
	Medium yellow
Note	

Accessories

Screwable cross-connection	
	2-pole
	3-pole
	4-pole
End plate	
	dark brown
	Tropical applications
End plate / Partition plate	
	dark brown
	Tropical applications
	dark brown
	Tropical applications
Cover / warning label	
	Cover / warning label

Marking systems	(see assortment in catalogue 7)
	Marking tags
For detailed information on other accessories and applications, refer to the „Accessories“ section	

SAKG 28 II

35 mm²

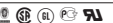

28 x 70 x 53	
150 / 50	
6...50	

IEC 60947-7-1		
IEC	UL	CSA
1000	600	600
125	115	110
35	AWG 8...2	AWG 6...1
8 / 3		
/ 5VA		
		
Rated connection		
3.0...6.0 Nm (M 6)		
Note		
Conductor connection with cable lugs according to DIN 46234 and DIN 46235, from 6 .. 50 mm ²		

Type	Qty.	Order No.
SAKG 28 II	10	0170320000

Type	current	Qty.	Order No.
QL 2 SAKG28	125 A	10	0551200000
QL 3 SAKG28	232 A	5	0407600000
QL 4 SAKG28	125 A	5	0407700000
Width			
EP 1 SAKG28/32 HP/DBR	2 mm	10	0205100000
EP 1 SAKG28/32 HP/TF/GE	2 mm	10	0205200000
TW SAKG28 HP/DBR/2	2 mm	10	0151400000
TW SAKG28 HP/TF/GE/2	2 mm	10	0164600000
AH 28 SAKG28	26 mm	5	0326660000

DEK 5/5

SAKG 28 II G

35 mm²



28 x 70 x 51.4	
150 / 50	
6...50	

IEC 60947-7-1		
IEC	UL	CSA
1000	600	600
125	95	110
35	AWG 8...2	AWG 6...1
8 /		
/ 5VA		
		
Rated connection		
3.0...6.0 Nm (M 6)		
Note		
Conductor connection with cable lugs according to DIN 46234 and DIN 46235, from 6 .. 50 mm ²		

Type	Qty.	Order No.
SAKG 28 II/GW	10	0185020000

Type	current	Qty.	Order No.
QL 2 SAKG28	125 A	10	0551200000
QL 3 SAKG28	232 A	5	0407600000
QL 4 SAKG28	125 A	5	0407700000
Width			
EP 1 SAKG28/32 HP/DBR	2 mm	10	0205100000
EP 1 SAKG28/32 HP/TF/GE	2 mm	10	0205200000
TW SAKG28 HP/DBR/2	2 mm	10	0151400000
TW SAKG28 HP/TF/GE/2	2 mm	10	0164600000
AH 28 SAKG28	26 mm	5	0326660000

DEK 5/5

Special terminals - SAKG

TS 32 / KrG

In hazardous area applications, the installation instructions and the rated data specifications for accessories given in the technical appendix must be followed.

Width/Length/height with TS32x7.5	mm
max. current / max. cond. cross-section	A/mm ²
Max. clamping range	mm ²

Technical data

Rated data

Rated voltage	V
Rated current	A
Rated cross-section	mm ²
Rated impulse voltage / Pollution severity	kV/-
Gauge to IEC 60947-1 / UL94 Flammability class	
Approvals	

Clamped conductors (H05V/H07V)

solid / stranded	mm ²
flexible / Stranded wire with end ferrules	mm ²
Tightening torque range (clamping screw)	
Stripping length / Blade size	mm/-

Note

Ordering data

Version

Medium yellow

Note

Accessories

Screwable cross-connection



2-pole
3-pole
4-pole

End plate

dark brown
Tropical applications

End plate / Partition plate

dark brown
Tropical applications
dark brown
Tropical applications

Cover / warning label

Cover / warning label

Marking systems (see assortment in catalogue 7)

Marking tags

For detailed information on other accessories and applications, refer to the „Accessories“ section

SAKG 28 III

35 mm²

28 x 70 x 63.5

150 / 50

6...50



IEC 60947-7-1

IEC	UL	CSA
1000	600	600
125	95	135
35	AWG 8...2	AWG 8...2
8 / 3		
B9 / 5VA		

Rated connection

6...16 / 6...50
10...35 / 6...35
4.0...6.0 Nm (M 6)
15 /

Type	Qty.	Order No.
SAKG 28 III	10	0170820000

Type	Qty.	Order No.

Width

Type	Width	Qty.	Order No.
EP 1 SAKG28/32 HP/DBR	2 mm	10	0205100000
EP 1 SAKG28/32 HP/TF/GE	2 mm	10	0205200000

TW SAKG28 HP/DBR/2 2 mm 10 0151400000

TW SAKG28 HP/TF/GE/2 2 mm 10 0164600000

AH 28 SAKG28 26 mm 5 0326660000

DEK 5/5

SAKG 32 I

50 mm²

32 x 87.3 x 84

192 / 70

10...70



IEC 60947-7-1

IEC	UL	CSA
1000	600	600
150	165	170
50	AWG 6...3/0	AWG 1...2/0
8 / 3		
B11 / 5VA		

Rated connection

10...16 / 10...70
10...70 / 10...70
6.0...12 Nm (M 8)
26 /

Type	Qty.	Order No.
SAKG 32 I	10	0286620000

Type	current	Qty.	Order No.
QL 2 SAKG32+70	150 A	5	0194000000
QL 3 SAKG32+70	150 A	5	0441500000
QL 4 SAKG32+70	150 A	5	0441600000

Width

Type	Width	Qty.	Order No.
EP 2 SAKG46/32 HP/DBR	2 mm	10	0205300000
EP 2 SAKG46/32 HP/TF/GE	2 mm	10	0205400000

TW SAKG46 HP/DBR/2 2 mm 10 0177100000

TW SAKG46 HP/TF/GE/2 2 mm 10 0179900000

AH 32 SAKG32 30 mm 5 0326760000

DEK 5/5

SAKG 32 II

50 mm²



32 x 80 x 53
192 / 70
10...70

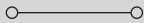

IEC 60947-7-1

IEC	UL	CSA
1000	600	600
150	200	170
50	AWG 6...3/0	AWG 1...2/0
	8 / 3	
	/ 5VA	



Rated connection

6.0...12 Nm (M 8)

Conductor connection with cable lugs according to DIN 46234 and DIN 46235, from 10 .. 70 mm²

Type	Qty.	Order No.
SAKG 32 II	10	0170420000

Type	current	Qty.	Order No.
QL 2 SAKG32+70	150 A	5	0194000000
QL 3 SAKG32+70	150 A	5	0441500000
QL 4 SAKG32+70	150 A	5	0441600000
Width			
EP 1 SAKG28/32 HP/DBR	2 mm	10	0205100000
EP 1 SAKG28/32 HP/TF/GE	2 mm	10	0205200000
Width			
TW SAKG46 HP/DBR/2	2 mm	10	0177100000
TW SAKG46 HP/TF/GE/2	2 mm	10	0179900000
AH 32 SAKG32	30 mm	5	0326760000

DEK 5/5

SAKG 32 II G

50 mm²



32 x 80 x 53
192 / 70
10...70



IEC 60947-7-1

IEC	UL	CSA
1000		600
150		170
50		AWG 1...2/0
		8 / 3
	/ 5VA	



Rated connection

6.0...12 Nm (M 8)

Conductor connection with cable lugs according to DIN 46234 and DIN 46235, from 10 .. 70 mm²

Type	Qty.	Order No.
SAKG 32 II/GW	10	0185120000

Type	current	Qty.	Order No.
QL 2 SAKG32+70	150 A	5	0194000000
QL 3 SAKG32+70	150 A	5	0441500000
QL 4 SAKG32+70	150 A	5	0441600000
Width			
EP 1 SAKG32/35 HP/DBR	2 mm	10	0180500000
EP 1 SAKG32/35 HP/TF/GE	2 mm	10	0180600000
TW SAKG28 HP/DBR/2	2 mm	10	0151400000
TW SAKG28 HP/TF/GE/2	2 mm	10	0164600000
AH 32 SAKG32	30 mm	5	0326760000

DEK 5/5

SAKG 32 III

50 mm²



32 x 94 x 84.5
192 / 70
10...70



IEC 60947-7-1

IEC	UL	CSA
1000	600	600
150	165	185
50	AWG 6...3/0	AWG 1...2/0
	8 / 3	
	B11 / 5VA	



Rated connection

10...16 / 10...70

10...70 / 10...70

6.0...12 Nm (M 8)

26 /

Type	Qty.	Order No.
SAKG 32 III	10	0286720000

Type	Qty.	Order No.
Width		
EP 2 SAKG46/32 HP/DBR	2 mm	10
EP 2 SAKG46/32 HP/TF/GE	2 mm	10
Width		
TW SAKG46 HP/DBR/2	2 mm	10
TW SAKG46 HP/TF/GE/2	2 mm	10
AH 32 SAKG32	30 mm	5

DEK 5/5

Special terminals - SAKG

TS 32 / KrG

In hazardous area applications, the installation instructions and the rated data specifications for accessories given in the technical appendix must be followed.

Width/Length/height with TS32x7.5 mm
 max. current / max. cond. cross-section A/mm²
 Max. clamping range mm²

Technical data

Rated data

Rated voltage	V
Rated current	A
Rated cross-section	mm ²
Rated impulse voltage / Pollution severity	kV/-
Gauge to IEC 60947-1 / UL94 Flammability class	

Approvals

Clamped conductors (H05V/H07V)

solid / stranded	mm ²
flexible / Stranded wire with end ferrules	mm ²
Tightening torque range (clamping screw)	
Stripping length / Blade size	mm/-

Note

Ordering data

Version

Medium yellow

Note

Accessories

Screwable cross-connection



2-pole
 3-pole
 4-pole

End plate

dark brown
 Tropical applications

End plate / Partition plate

dark brown
 Tropical applications
 dark brown
 Tropical applications

Cover / warning label

Cover / warning label

Marking systems (see assortment in catalogue 7)

Marking tags

For detailed information on other accessories and applications, refer to the „Accessories“ section

SAKG 70 II G

70 mm²

32 x 84 x 51.4

192 / 95

10...95



IEC 60947-7-1

IEC	UL	CSA
1000		600
192		200
70	AWG 6...3/0	AWG 2/0...4/0
	8 / 3	
	/ 5VA	



Rated connection

10...16

6.0...12 Nm (M 8)

Conductor connection with cable lugs according to DIN 46234 with 16...95 mm² and DIN 46235 with 10...50 mm²

Type	Qty.	Order No.
SAKG 70 II/GW	10	0150420000

Type	current	Qty.	Order No.
QL 2 SAKG32+70	150 A	5	0194000000
QL 3 SAKG32+70	150 A	5	0441500000
QL 4 SAKG32+70	150 A	5	0441600000

Width

EP 1 SAKG28/32 HP/DBR	2 mm	10	0205100000
EP 1 SAKG28/32 HP/TF/GE	2 mm	10	0205200000

TW SAKG28 HP/DBR/2	2 mm	10	0151400000
TW SAKG28 HP/TF/GE/2	2 mm	10	0164600000

AH 32 SAKG32	30 mm	5	0326760000
--------------	-------	---	------------

DEK 5/5

SAKG 40 I

95 mm²

40 x 94 x 84.5

232 / 95

10...95



IEC 60947-7-1

IEC	UL	CSA
1000	600	600
232	195	250
95	AWG 2/0...4/0	AWG 2/0...4/0
	8 / 3	
	B12 / 5VA	



Rated connection

10...16 / 10...95

10...95 / 10...95

10...20 Nm (M 10)

25 /

Conductor connection with cable lugs acc. to DIN 46234 from 10...95 mm²

Type	Qty.	Order No.
SAKG 40 I	10	0286820000

Type	current	Qty.	Order No.
QL 2 SAKG40	232 A	5	0194100000
QL 3 SAKG40	232 A	5	0263500000
QL 4 SAKG40	232 A	5	0409800000

Width

EP 2 SAKG46/32 HP/DBR	2 mm	10	0205300000
EP 2 SAKG46/32 HP/TF/GE	2 mm	10	0205400000

TW SAKG46 HP/DBR/2	2 mm	10	0177100000
TW SAKG46 HP/TF/GE/2	2 mm	10	0179900000

AH 40 SAKG40	38 mm	5	0326860000
--------------	-------	---	------------

DEK 5/5

SAKG 40 II

95 mm²



40 x 90 x 53
232 / 95
10...95

IEC 60947-7-1

IEC	UL	CSA
1000	600	600
232	230	250
95	AWG 1...4/0	AWG 2/0...4/0
	8 / 3	
	/ 5VA	



Rated connection

...16

10...20 Nm (M 10)

Conductor connection with cable lugs according to DIN 46234, from 10 ... 95 mm²

Type	Qty.	Order No.
SAKG 40 II	10	0170520000

Type	current	Qty.	Order No.
QL 2 SAKG40	232 A	5	0194100000
QL 3 SAKG40	232 A	5	0263500000
QL 4 SAKG40	232 A	5	0409800000
Width			
EP 2 SAKG46/32 HP/DBR	2 mm	10	0205300000
EP 2 SAKG46/32 HP/TF/GE	2 mm	10	0205400000
Width			
TW SAKG46 HP/DBR/2	2 mm	10	0177100000
TW SAKG46 HP/TF/GE/2	2 mm	10	0179900000
AH 40 SAKG40	38 mm	5	0326860000

DEK 5/5

SAKG 40 II GW

95 mm²



40 x 90 x 53
232 / 95
10...95

IEC 60947-7-1

IEC	UL	CSA
1000	600	600
232	230	250
95	AWG 1...4/0	AWG 2/0...4/0
	8 / 3	
	/ 5VA	



Rated connection

...16

10...20 Nm (M 10)

Conductor connection with cable lugs according to DIN 46234, from 10 ... 95 mm²

Type	Qty.	Order No.
SAKG 40 II/GW	10	0185220000

Type	current	Qty.	Order No.
QL 2 SAKG40	232 A	5	0194100000
QL 3 SAKG40	232 A	5	0263500000
QL 4 SAKG40	232 A	5	0409800000
Width			
EP 2 SAKG46/32 HP/DBR	2 mm	10	0205300000
EP 2 SAKG46/32 HP/TF/GE	2 mm	10	0205400000
Width			
TW SAKG46 HP/DBR/2	2 mm	10	0177100000
TW SAKG46 HP/TF/GE/2	2 mm	10	0179900000
AH 40 SAKG40	38 mm	5	0326860000

DEK 5/5

SAKG 40 III

95 mm²



40 x 98 x 84.5
232 / 95
10...95

IEC 60947-7-1

IEC	UL	CSA
1000	600	600
232	195	230
95	AWG 1...4/0	AWG 2/0...4/0
	8 / 3	
	B12 / 5VA	



Rated connection

10...16 / 10...95

10...95 / 10...95

16...20 Nm (M 10)

25 /

Type	Qty.	Order No.
SAKG 40 III	10	0286920000

Type	current	Qty.	Order No.
QL 2 SAKG40	232 A	5	0194100000
QL 3 SAKG40	232 A	5	0263500000
QL 4 SAKG40	232 A	5	0409800000
Width			
EP 2 SAKG46/32 HP/DBR	2 mm	10	0205300000
EP 2 SAKG46/32 HP/TF/GE	2 mm	10	0205400000
Width			
TW SAKG46 HP/DBR/2	2 mm	10	0177100000
TW SAKG46 HP/TF/GE/2	2 mm	10	0179900000
AH 40 SAKG40	38 mm	5	0326860000

DEK 5/5

Special terminals - SAKG

TS 32 / KrG

In hazardous area applications, the installation instructions and the rated data specifications for accessories given in the technical appendix must be followed.

Width/Length/height with TS32x7.5 mm
 max. current / max. cond. cross-section A/mm²
 Max. clamping range mm²

Technical data

Rated data

Rated voltage V
 Rated current A
 Rated cross-section mm²
 Rated impulse voltage / Pollution severity kV/-
 Gauge to IEC 60947-1 / UL94 Flammability class

Clamped conductors (H05V/H07V)

solid / stranded mm²
 flexible / Stranded wire with end ferrules mm²
 Tightening torque range (clamping screw)
 Stripping length / Blade size mm/-

Note

Ordering data

Version

Medium yellow

Note

Accessories

Screwable cross-connection



2-pole
 3-pole
 4-pole

End plate

dark brown
 Tropical applications

End plate / Partition plate

dark brown
 Tropical applications
 dark brown
 Tropical applications

Cover / warning label

Cover / warning label

Marking systems

(see assortment in catalogue 7)

Marking tags

For detailed information on other accessories and applications, refer to the „Accessories“ section

SAKG 46 II

150 mm²

46 x 106 x 57
353 / 185
10...185

IEC 60947-7-1

IEC	UL	CSA
1000	600	600
309	285	365
150	AWG 4/0...300	AWG 4...300
8 / 3		
/ 5VA		

Rated connection

10...16

14...31 Nm M 12

Conductor connection with cable lugs according to DIN 46234, from 10 .. 185 mm² and DIN 46235, from 25 .. 150 mm²

Type	Qty.	Order No.
SAKG 46 II	5	0170620000

Type	current	Qty.	Order No.
QL 2 SAKG46	309 A	5	0247000000
QL 3 SAKG46	309 A	5	0444400000
QL 4 SAKG46	309 A	5	0444500000
Width			
EP 2 SAKG46/32 HP/DBR	2 mm	10	0205300000
EP 2 SAKG46/32 HP/TF/GE	2 mm	10	0205400000
TW SAKG46 HP/DBR/2			
TW SAKG46 HP/DBR/2	2 mm	10	0177100000
TW SAKG46 HP/TF/GE/2	2 mm	10	0179900000
AH 46 SAKG46			
AH 46 SAKG46	46 mm	5	0326960000

DEK 5/5

SAKG 46 II GW

150 mm²

46 x 106 x 57
353 / 185
10...185

IEC 60947-7-1

IEC	UL	CSA
1000	600	600
309	285	365
150	AWG 4/0...kcmil 300	AWG 1...300
8 / 3		
/ 5VA		

Rated connection

10...16

14...31 Nm M 12

Conductor connection with cable lugs according to DIN 46234, from 10 .. 185 mm² and DIN 46235, from 25 .. 150 mm²

Type	Qty.	Order No.
SAKG 46 II/GW	5	0185320000

Type	current	Qty.	Order No.
QL 2 SAKG46	309 A	5	0247000000
QL 3 SAKG46	309 A	5	0444400000
QL 4 SAKG46	309 A	5	0444500000
Width			
EP 2 SAKG46/32 HP/DBR	2 mm	10	0205300000
EP 2 SAKG46/32 HP/TF/GE	2 mm	10	0205400000
TW SAKG46 HP/DBR/2			
TW SAKG46 HP/DBR/2	2 mm	10	0177100000
TW SAKG46 HP/TF/GE/2	2 mm	10	0179900000
AH 46 SAKG46			
AH 46 SAKG46	46 mm	5	0326960000

DEK 5/5

SAKG 54 II

240 mm²



54 x 122 x 60,5
415 / 240
10...240

IEC 60947-7-1

IEC	UL	CSA
1000	600	600
415	380	600
240	kcmil 300...kcmil 500 kcmil 300...kcmil 500	
8 / 3		
/ 5VA		



Rated connection

25...60 Nm M 16

Conductor connection with cable lugs according to DIN 46234 and DIN 46235, from 70 .. 240 mm²

Type	Qty.	Order No.
SAKG 54 II	5	0170720000

Type	current	Qty.	Order No.
QL 2 SAKG54	415 A	5	0264400000
QL 3 SAKG54	415 A	5	0408000000
QL 4 SAKG54	415 A	5	0247400000
Width			
EP 2 SAKG46/32 HP/DBR	2 mm	10	0205300000
EP 2 SAKG46/32 HP/TF/GE	2 mm	10	0205400000
TW SAKG46 HP/DBR/2	2 mm	10	0177100000
TW SAKG46 HP/TF/GE/2	2 mm	10	0179900000

DEK 5/5

SAKG 54 II GW

240 mm²



54 x 122 x 60,5
415 / 240
10...240

IEC 60947-7-1

IEC	UL	CSA
1000	600	600
415	380	600
240	kcmil 300...kcmil 500 kcmil 300...kcmil 500	
8 / 3		
/ 5VA		



Rated connection

25...60 Nm M 16

Conductor connection with cable lugs according to DIN 46234 and DIN 46235, from 70 .. 240 mm²

Type	Qty.	Order No.
SAKG 54 II/GW	5	0185420000

Type	current	Qty.	Order No.
QL 2 SAKG54	415 A	5	0264400000
QL 3 SAKG54	415 A	5	0408000000
QL 4 SAKG54	415 A	5	0247400000
Width			
EP 2 SAKG46/32 HP/DBR	2 mm	10	0205300000
EP 2 SAKG46/32 HP/TF/GE	2 mm	10	0205400000
TW SAKG46 HP/DBR/2	2 mm	10	0177100000
TW SAKG46 HP/TF/GE/2	2 mm	10	0179900000

DEK 5/5

Stud terminal - KST

TS 32 / PA

In hazardous area applications, the installation instructions and the rated data specifications for accessories given in the technical appendix must be followed.

Width/Length/height with TS32x7.5	mm
max. current / max. cond. cross-section	A/mm ²
Max. clamping range	mm ²

Technical data

Rated data

Rated voltage	V
Rated current	A
Rated cross-section	mm ²
Rated impulse voltage / Pollution severity	kV/-
Gauge to IEC 60947-1 / UL94 Flammability class	
Approvals	

Tightening torque range (clamping screw)

Note

Ordering data

Version

TS 35 x 7,5

Note

Accessories

Screwable cross-connection

2-pole

Partition plate

left
right

KST 5

10 mm²



24 x 60 x 55

57 /



IEC	UL	CSA
1000	600	600
57	50	65
10	AWG 12...6	AWG 8...2
	8 / 3	
	/ V2	



Rated connection

2.0...4.0 Nm

KST 6

16 mm²



22 x 60 x 60

76 /

...



IEC	UL	CSA
1000	600	600
76	65	80
16	AWG 12...6	AWG 12...6
	8 / 3	
	/ V2	



Rated connection

3.0...6.0 Nm

Type	Qty.	Order No.
KST 5	25	9503370000

Type	Qty.	Order No.
KST 6	25	9501310000

Type	Qty.	Order No.
Width		
TW KST5-12 LI/NO 160/HM	10	1752800000
TW KST5-12 RE/NO 160/HM	10	1718530000

Type	current	Qty.	Order No.
QL 2 KST6		5	9501350000
Width			
TW KST5-12 LI/NO 160/HM		10	1752800000
TW KST5-12 RE/NO 160/HM		10	1718530000

Marking systems (see assortment in catalogue 7)

Marking tags

For detailed information on other accessories and applications, refer to the „Accessories“ section

DEK 5/5

DEK 5/5

KST 8

35 mm²



24 x 60 x 72

125 /

...



IEC	UL	CSA
1000	600	600
125	115	130
35	AWG 12...2	AWG 12...2
	8 / 3	
	/ V2	



Rated connection

6.0...12 Nm

Type	Qty.	Order No.
KST 8	25	9501320000

Type	current	Qty.	Order No.
QL 2 KST8		5	9501360000
Width			
TW KST5-12 LI/NO 160/HM		10	1752800000
TW KST5-12 RE/NO 160/HM		10	1718530000

DEK 5/5

KST 10

70 mm²



34 x 60 x 82

192 /

...



IEC	UL	CSA
1000	600	600
192	175	200
70	AWG 12...2/0	AWG 12...2/0
	8 / 3	
	/ V2	



Rated connection

10...20 Nm

Type	Qty.	Order No.
KST 10	20	9501330000

Type	current	Qty.	Order No.
QL 2 KST10		5	9501370000
Width			
TW KST5-12 LI/NO 160/HM		10	1752800000
TW KST5-12 RE/NO 160/HM		10	1718530000

DEK 5/5

KST 12

95 mm²



34 x 60 x 82

232 /

...



IEC	UL	CSA
1000	600	600
232	200	250
95	AWG 12...3	AWG 12...3/0
	8 / 3	
	/ V2	



Rated connection

14...31 Nm

Type	Qty.	Order No.
KST 12	20	9501340000

Type	current	Qty.	Order No.
QL 2 KST12	232 A	5	9501380000
Width			
TW KST5-12 LI/NO 160/HM		10	1752800000
TW KST5-12 RE/NO 160/HM		10	1718530000

DEK 5/5

Terminals with electronic components

with indication

In hazardous area applications, the installation instructions and the rated data specifications for accessories given in the technical appendix must be followed.

Width/Length/height with TS32x7.5	mm
max. current / max. cond. cross-section	A/mm ²
Max. clamping range	mm ²

Technical data

Rated data	
Rated voltage	V
Rated current	A
Rated cross-section	mm ²
Rated impulse voltage / Pollution severity	kV/-
Gauge to IEC 60947-1 / UL94 Flammability class	
Approvals	
Electronic fixtures	
Diode reverse voltage / Diode current	-
Operating voltage for display, min. / Current	V/mA
Clamped conductors (H05V/H07V)	
solid / stranded	mm ²
flexible / Stranded wire with end ferrules	mm ²
Tightening torque range (clamping screw)	
Stripping length / Blade size	mm/-
Note	

Ordering data

Version	
	Red LED
	Green LED
	Neon lamp
Note	

Accessories

Screwable cross-connection	
	2-pole
	3-pole
	4-pole
External cross-connection	
	2-pole
	3-pole
	4-pole
Switchable link	
Mounting screw	BFSC M2.5X14 SAKD2.5N
Switchable link	VL 2 AKZ4/DK4
Connecting sleeve	VH 10/4/2.8 AKZ4
Testing / Checking	
Test plug	PS 2.3 RT
Socket	STB 8.5/D4/2.3/M2.5 AKZ
End plate / Partition plate	
beige	AP DK4
Small partition	
Small partition	TSCH 4 AKZ4

Marking systems	
(see assortment in catalogue 7)	
Marking tags	DEK 5/6
For detailed information on other accessories and applications, refer to the „Accessories“ section	

DK 4 LD/1

4 mm²

DC voltage indicator

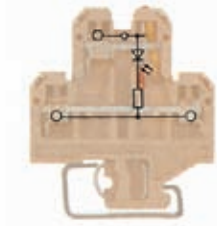

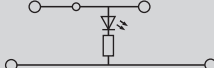
6 x 50 x 56.5	
10 / 4	
0.5...4	

IEC 60947-7-1

IEC	UL	CSA
24		
10		
4		
	1 / 3	
	A3 / V2	
		
24 / 5		
Rated connection		
0.5...4 / 0.5...4		
0.5...4 / 0.5...4		
0.5...1.0 Nm (M 3)		
9 / 0.6 x 3.5 mm		
Note		

Type	Qty.	Order No.
DK 4/32 LD ROT 24VDC A1	25	0495360000
Note		

Type	current	Qty.	Order No.
Q 2 AKZ4	32 A	50	0336400000
Q 3 AKZ4	32 A	50	0336500000
Q 4 AKZ4	32 A	50	0336600000
QB 2 WI RA6 IS	27 A	50	0482700000
QB 3 WI RA6 IS	27 A	50	0482800000
QB 4 WI RA6 IS	27 A	50	0482900000
BFSC M2.5X14 SAKD2.5N		100	0266800000
VL 2 AKZ4/DK4		50	0446700000
VH 10/4/2.8 AKZ4		50	0446600000
	Width		
PS 2.3 RT	5.4 mm	20	0180400000
STB 8.5/D4/2.3/M2.5 AKZ		50	0215700000
AP DK4	1.5 mm	20	0359260000
TSCH 4 AKZ4	6 mm	100	0363360000

Marking systems	
(see assortment in catalogue 7)	
Marking tags	DEK 5/6
For detailed information on other accessories and applications, refer to the „Accessories“ section	

DK 4 LD/2

4 mm²

DC voltage indicator

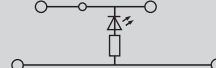

6 x 50 x 56.5	
10 / 4	
0.5...4	

IEC 60947-7-1

IEC	UL	CSA
24		
10		
4		
	1 / 3	
	A3 / V2	
		
24 / 5		
Rated connection		
0.5...4 / 0.5...4		
0.5...4 / 0.5...4		
0.5...1.0 Nm (M 3)		
9 / 0.6 x 3.5 mm		
Note		

Type	Qty.	Order No.
DK 4/32 LD ROT 24VDC A2	25	0474460000
DK 4/32 LD GR 24VDC A2	25	0646560000
Note		

Type	current	Qty.	Order No.
Q 2 AKZ4	32 A	50	0336400000
Q 3 AKZ4	32 A	50	0336500000
Q 4 AKZ4	32 A	50	0336600000
QB 2 WI RA6 IS	27 A	50	0482700000
QB 3 WI RA6 IS	27 A	50	0482800000
QB 4 WI RA6 IS	27 A	50	0482900000
BFSC M2.5X14 SAKD2.5N		100	0266800000
VL 2 AKZ4/DK4		50	0446700000
VH 10/4/2.8 AKZ4		50	0446600000
	Width		
PS 2.3 RT	5.4 mm	20	0180400000
STB 8.5/D4/2.3/M2.5 AKZ		50	0215700000
AP DK4	1.5 mm	20	0359260000
TSCH 4 AKZ4	6 mm	100	0363360000

Marking systems	
(see assortment in catalogue 7)	
Marking tags	DEK 5/6
For detailed information on other accessories and applications, refer to the „Accessories“ section	

DK 4 LD/3

4 mm²

DC voltage indicator



6 x 50 x 56.5
10 / 4
0.5...4

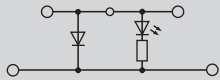

IEC 60947-7-1

IEC	UL	CSA
24		
10		
4		
	1 / 3	
	A3 / V2	



24 / 5

Rated connection

0.5...4 / 0.5...4

0.5...4 / 0.5...4

0.5...1.0 Nm (M 3)

9 / 0.6 x 3.5 mm

DK 4 GL

4 mm²

AC voltage indicator



6 x 50 x 56.5
10 / 4
0.33...4

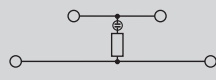

IEC 60947-7-1

IEC	UL	CSA
115		
10		
4		
	1 / 3	
	A3 / V2	



24 / 5

Rated connection

0.5...4 / 0.5...4

0.5...4 / 0.5...4

0.5...1.0 Nm (M 3)

9 / 0.6 x 3.5 mm

Type	Qty.	Order No.
DK 4/32 LD ROT 24VDC	25	0210160000

Type	Qty.	Order No.
DK 4/32 GL 100K 115VAC	25	0569560000

Type	current	Qty.	Order No.
Q 2 AKZ4	32 A	50	0336400000
Q 3 AKZ4	32 A	50	0336500000
Q 4 AKZ4	32 A	50	0336600000
QB 2 WI RA6 IS	27 A	50	0482700000
QB 3 WI RA6 IS	27 A	50	0482800000
QB 4 WI RA6 IS	27 A	50	0482900000
BFSC M2.5X14 SAKD2.5N		100	0266800000
VL 2 AKZ4/DK4		50	0446700000
VH 10/4/2.8 AKZ4		50	0446600000
	Width		
PS 2.3 RT	5.4 mm	20	0180400000
STB 8.5/D4/2.3/M2.5 AKZ		50	0215700000
AP DK4	1.5 mm	20	0359260000
TSCH 4 AKZ4	6 mm	100	0363360000

Type	current	Qty.	Order No.
Q 2 AKZ4	32 A	50	0336400000
Q 3 AKZ4	32 A	50	0336500000
Q 4 AKZ4	32 A	50	0336600000
QB 2 WI RA6 IS	27 A	50	0482700000
QB 3 WI RA6 IS	27 A	50	0482800000
QB 4 WI RA6 IS	27 A	50	0482900000
BFSC M2.5X14 SAKD2.5N		100	0266800000
VL 2 AKZ4/DK4	32 A	50	0446700000
VH 10/4/2.8 AKZ4		50	0446600000
	Width		
PS 2.3 RT	5.4 mm	20	0180400000
STB 8.5/D4/2.3/M2.5 AKZ		50	0215700000
AP DK4	1.5 mm	20	0359260000
TSCH 4 AKZ4	6 mm	100	0363360000

DEK 5/6

DEK 5/6

Terminals with electronic components

with diodes

In hazardous area applications, the installation instructions and the rated data specifications for accessories given in the technical appendix must be followed.

Width/Length/height with TS32x7.5	mm
max. current / max. cond. cross-section	A/mm ²
Max. clamping range	mm ²

Technical data

Rated data	
Rated voltage	V
Rated current	A
Rated cross-section	mm ²
Rated impulse voltage / Pollution severity	kV/-
Gauge to IEC 60947-1 / UL94 Flammability class	
Approvals	
Electronic fixtures	
Diode reverse voltage / Diode current	A
Operating voltage for display, min. / Current	-/A
Clamped conductors (H05V/H07V)	
solid / stranded	mm ²
flexible / Stranded wire with end ferrules	mm ²
Tightening torque range (clamping screw)	
Stripping length / Blade size	mm/-
Note	

Ordering data

Version	
	Red LED
Note	

Accessories

Screwable cross-connection	
	2-pole
	3-pole
	4-pole
External cross-connection	
	2-pole
	3-pole
	4-pole
Switchable link	
Mounting screw	
Switchable link	
Connecting sleeve	
Testing / Checking	
Test plug	
Socket	
End plate / Partition plate	
beige	
Small partition	
Small partition	

Marking systems (see assortment in catalogue 7)
Marking tags



For detailed information on other accessories and applications, refer to the „Accessories“ section

DK 4 D/1

4 mm²

Diode terminal, e.g. as reverse polarity protection

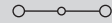

6 x 50 x 56.5	
10 / 4	
0.33...4	

IEC	UL	CSA
380		300
10		10
4		AWG 22...12
		/ 3
		A3 / V2
		
1000 / 1		
Rated connection		
0.5...4 / 0.5...4		
0.5...4 / 0.5...4		
0.5...0.8 Nm (M 3)		
9 / 0.6 x 3.5 mm		
Diode current: max 1A. (1 N 4007)		

Type	Qty.	Order No.
DK 4/32 1D CSA GET.SCH.	25	0544660000

Type	current	Qty.	Order No.
Q 2 AKZ4	32 A	50	0336400000
Q 3 AKZ4	32 A	50	0336500000
Q 4 AKZ4	32 A	50	0336600000
QB			
QB 2 WI RA6 IS	27 A	50	0482700000
QB 3 WI RA6 IS	27 A	50	0482800000
QB 4 WI RA6 IS	27 A	50	0482900000
BFSC			
BFSC M2.5X14 SAKD2.5N		100	0266800000
VL			
VL 2 AKZ4/DK4	32 A	50	0446700000
VH			
VH 10/4/2.8 AKZ4		50	0446600000
Width			
PS 2.3 RT	5.4 mm	20	0180400000
STB 8.5/D4/2.3/M2.5 AKZ		50	0215700000
AP			
AP DK4	1.5 mm	20	0359260000
TSCH			
TSCH 4 AKZ4	6 mm	100	0363360000

DEK 5/6

DK 4 D/2

4 mm²

Suppressor circuit for contactor and solenoid valve (DC voltage)

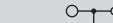
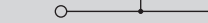

6 x 50 x 56.5	
10 / 4	
0.33...4	

IEC	UL	CSA
380		300
10		10
4		AWG 22...12
		/ 3
		A3 / V2
		
1000 / 1		
Rated connection		
0.5...4 / 0.5...4		
0.5...4 / 0.5...4		
0.5...0.8 Nm (M 3)		
9 / 0.6 x 3.5 mm		
Diode current: max 1A. (1 N 4007)		

Type	Qty.	Order No.
DK 4/32 1D CSA A1	25	0484060000

Type	current	Qty.	Order No.
Q 2 AKZ4	32 A	50	0336400000
Q 3 AKZ4	32 A	50	0336500000
Q 4 AKZ4	32 A	50	0336600000
QB			
QB 2 WI RA6 IS	27 A	50	0482700000
QB 3 WI RA6 IS	27 A	50	0482800000
QB 4 WI RA6 IS	27 A	50	0482900000
BFSC			
BFSC M2.5X14 SAKD2.5N		100	0266800000
VL			
VL 2 AKZ4/DK4	32 A	50	0446700000
VH			
VH 10/4/2.8 AKZ4		50	0446600000
Width			
PS 2.3 RT	5.4 mm	20	0180400000
STB 8.5/D4/2.3/M2.5 AKZ		50	0215700000
AP			
AP DK4	1.5 mm	20	0359260000
TSCH			
TSCH 4 AKZ4	6 mm	100	0363360000

DEK 5/6

DK 4 D/3

4 mm²

Suppressor circuit for contactor and solenoid valve (DC voltage)



6 x 50 x 56.5
10 / 4
0.33...4

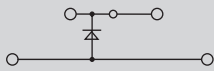

IEC	UL	CSA
380		300
10		10
4		
/ 3		
A3 / V2		
1000 / 1		
Rated connection		
0.5...4 / 0.5...4		
0.5...4 / 0.5...4		
0.5...0.8 Nm (M 3)		
9 / 0.6 x 3.5 mm		
Diode current: max 1A. (1 N 4007)		

Type	Qty.	Order No.
DK 4/32 1D CSA A2	25	0467960000

Type	current	Qty.	Order No.
Q 2 AKZ4	32 A	50	0336400000
Q 3 AKZ4	32 A	50	0336500000
Q 4 AKZ4	32 A	50	0336600000
Width			
QB 2 WI RA6 IS	27 A	50	0482700000
QB 3 WI RA6 IS	27 A	50	0482800000
QB 4 WI RA6 IS	27 A	50	0482900000
BFSC M2.5X14 SAKD2.5N	100	0266800000	
VL 2 AKZ4/DK4	50	0446700000	
VH 10/4/2.8 AKZ4	50	0446600000	
Width			
PS 2.3 RT	5.4 mm	20	0180400000
STB 8.5/D4/2.3/M2.5 AKZ	50	0215700000	
AP DK4	1.5 mm	20	0359260000
TSCH 4 AKZ4	6 mm	100	0363360000

DEK 5/6

DK 4 D/4

4 mm²

Diode terminal for lamp test circuits

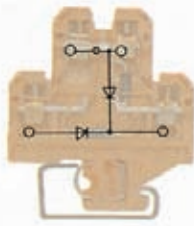

6 x 50 x 56.5
10 / 4
0.33...4

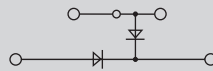

IEC	UL	CSA
380		300
10		10
4		
/ 3		
A3 / V2		
1000 / 1		
Rated connection		
0.5...4 / 0.5...4		
0.5...4 / 0.5...4		
0.5...0.8 Nm (M 3)		
9 / 0.6 x 3.5 mm		
Diode current: max 1A. (1 N 4007)		

Type	Qty.	Order No.
DK 4/32 2D CSA GET.SCH.	25	0642760000

Type	current	Qty.	Order No.
Q 2 AKZ4	32 A	50	0336400000
Q 3 AKZ4	32 A	50	0336500000
Q 4 AKZ4	32 A	50	0336600000
Width			
QB 2 WI RA6 IS	27 A	50	0482700000
QB 3 WI RA6 IS	27 A	50	0482800000
QB 4 WI RA6 IS	27 A	50	0482900000
BFSC M2.5X14 SAKD2.5N	100	0266800000	
VL 2 AKZ4/DK4	50	0446700000	
VH 10/4/2.8 AKZ4	50	0446600000	
Width			
PS 2.3 RT	5.4 mm	20	0180400000
STB 8.5/D4/2.3/M2.5 AKZ	50	0215700000	
AP DK4	1.5 mm	20	0359260000
TSCH 4 AKZ4	6 mm	100	0363360000

DEK 5/6

DK 4 D/5

4 mm²

Diode terminal for lamp test circuits



6 x 50 x 56.5
10 / 4
0.33...4

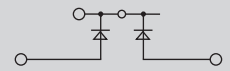

IEC	UL	CSA
380		300
10		10
4		
/ 3		
A3 / V2		
1000 / 1		
Rated connection		
0.5...4 / 0.5...4		
0.5...4 / 0.5...4		
0.5...0.8 Nm (M 3)		
9 / 0.6 x 3.5 mm		
Diode current: max 1A. (1 N 4007)		

Type	Qty.	Order No.
DK 4/32 2D CSA A2	25	0523760000

Type	current	Qty.	Order No.
Q 2 AKZ4	32 A	50	0336400000
Q 3 AKZ4	32 A	50	0336500000
Q 4 AKZ4	32 A	50	0336600000
Width			
QB 2 WI RA6 IS	27 A	50	0482700000
QB 3 WI RA6 IS	27 A	50	0482800000
QB 4 WI RA6 IS	27 A	50	0482900000
BFSC M2.5X14 SAKD2.5N	100	0266800000	
VL 2 AKZ4/DK4	32 A	50	0446700000
VH 10/4/2.8 AKZ4	50	0446600000	
Width			
PS 2.3 RT	5.4 mm	20	0180400000
STB 8.5/D4/2.3/M2.5 AKZ	50	0215700000	
AP DK4	1.5 mm	20	0359260000
TSCH 4 AKZ4	6 mm	100	0363360000

DEK 5/6

Terminals with electronic components

with diodes

In hazardous area applications, the installation instructions and the rated data specifications for accessories given in the technical appendix must be followed.

Width/Length/height with TS32x7.5	mm
max. current / max. cond. cross-section	A/mm ²
Max. clamping range	mm ²

Technical data

Rated data	
Rated voltage	V
Rated current	A
Rated cross-section	mm ²
Rated impulse voltage / Pollution severity	kV/-
Gauge to IEC 60947-1 / UL94 Flammability class	
Approvals	

Electronic fixtures

Diode reverse voltage / Diode current	A
Operating voltage for display, min. / Current	-/A

Clamped conductors (H05V/H07V)

solid / stranded	mm ²
flexible / Stranded wire with end ferrules	mm ²
Tightening torque range (clamping screw)	
Stripping length / Blade size	mm/-

Note

Ordering data

Version	
	Red LED
Note	

Accessories

Screwable cross-connection	
	2-pole
	3-pole
	4-pole
External cross-connection	
	2-pole
	3-pole
	4-pole
Switchable link	
Mounting screw	
Switchable link	
Connecting sleeve	
Testing / Checking	
Test plug	
Socket	
End plate / Partition plate	
	beige
Small partition	
	Small partition

Marking systems	(see assortment in catalogue 7)
	Marking tags

For detailed information on other accessories and applications, refer to the „Accessories“ section

DK 4 D/6

4 mm²

Diode terminal for lamp test circuits

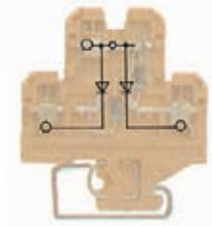

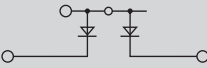
6 x 50 x 56.5	
10 / 4	
0.33...4	

IEC	UL	CSA
380		300
10		10
4		
	/ 3	
	A3 / V2	
		
1000 / 1		
Rated connection		
0.5...4 / 0.5...4		
0.5...4 / 0.5...4		
0.5...0.8 Nm (M 3)		
9 / 0.6 x 3.5 mm		
Diode current: max 1A. (1 N 4007)		

Type	Qty.	Order No.
DK 4/32 2D A1	25	0663960000

Type	current	Qty.	Order No.
Q 2 AKZ4	32 A	50	0336400000
Q 3 AKZ4	32 A	50	0336500000
Q 4 AKZ4	32 A	50	0336600000
<hr/>			
QB 2 WI RA6 IS	27 A	50	0482700000
QB 3 WI RA6 IS	27 A	50	0482800000
QB 4 WI RA6 IS	27 A	50	0482900000
<hr/>			
BFSC M2.5X14 SAKD2.5N		100	0266800000
VL 2 AKZ4/DK4		50	0446700000
VH 10/4/2.8 AKZ4		50	0446600000
<hr/>			
		Width	
PS 2.3 RT	5.4 mm	20	0180400000
STB 8.5/D4/2.3/M2.5 AKZ		50	0215700000
<hr/>			
AP DK4	1.5 mm	20	0359260000
<hr/>			
TSCH 4 AKZ4	6 mm	100	0363360000

DEK 5/6

DK 4 D/7

4 mm²

Diode terminal for lamp test circuits, with protective resistor

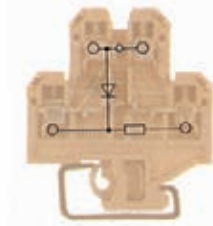

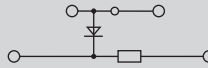
6 x 50 x 56.5	
10 / 4	
0.33...4	

IEC	UL	CSA
24		300
10		10
4		
	/ 3	
	A3 / V2	
		
/ 1		
Rated connection		
0.5...4 / 0.5...4		
0.5...4 / 0.5...4		
0.5...0.8 Nm (M 3)		
9 / 0.6 x 3.5 mm		
Diode current: max 1A. (1 N 4007)		

Type	Qty.	Order No.
DK 4/32 1D 1K5	25	0685260000

Type	current	Qty.	Order No.
Q 2 AKZ4	32 A	50	0336400000
Q 3 AKZ4	32 A	50	0336500000
Q 4 AKZ4	32 A	50	0336600000
<hr/>			
QB 2 WI RA6 IS	27 A	50	0482700000
QB 3 WI RA6 IS	27 A	50	0482800000
QB 4 WI RA6 IS	27 A	50	0482900000
<hr/>			
BFSC M2.5X14 SAKD2.5N		100	0266800000
VL 2 AKZ4/DK4		50	0446700000
VH 10/4/2.8 AKZ4		50	0446600000
<hr/>			
		Width	
PS 2.3 RT	5.4 mm	20	0180400000
STB 8.5/D4/2.3/M2.5 AKZ		50	0215700000
<hr/>			
AP DK4	1.5 mm	20	0359260000
<hr/>			
TSCH 4 AKZ4	6 mm	100	0363360000

DEK 5/6

with electronic components

In hazardous area applications, the installation instructions and the rated data specifications for accessories given in the technical appendix must be followed.

Width/Length/height with TS32x7.5	mm
max. current / max. cond. cross-section	A/mm ²
Max. clamping range	mm ²

Technical data

Rated data	
Rated voltage	V
Rated current	A
Rated cross-section	mm ²
Rated impulse voltage / Pollution severity	kV/-
Gauge to IEC 60947-1 / UL94 Flammability class	
Approvals	
Clamped conductors (H05V/H07V)	
solid / stranded	mm ²
flexible / Stranded wire with end ferrules	mm ²
Tightening torque range (clamping screw)	
Stripping length / Blade size	mm/-
Note	

Ordering data

Version	
	Red LED
Note	

Accessories

Screwable cross-connection	
	2-pole
	3-pole
	4-pole
External cross-connection	
	2-pole
	3-pole
	4-pole
End plate / Partition plate	
	beige
Testing / Checking	
	Test plug
	Socket
Small partition	
	Small partition

Marking systems (see assortment in catalogue 7)
Marking tags

For detailed information on other accessories and applications, refer to the „Accessories“ section

DK 4 RC

4 mm²

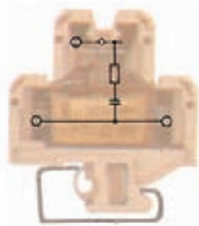

18 x 50 x 56.5
10 / 4
0.33...4

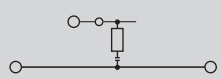

IEC	UL	CSA
230		
10		
4		
	/ 3	
	A3 / V2	
Rated connection		
0.5...4 / 0.5...4		
0.5...4 / 0.5...4		
0.5...0.8 Nm (M 3)		
9 / 0.6 x 3.5 mm		

Type	Qty.	Order No.
DK 4/32 RC 220R/220NF	5	0692160000

Type	current	Qty.	Order No.
Q 2 AKZ4	32 A	50	0336400000
Q 3 AKZ4	32 A	50	0336500000
Q 4 AKZ4	32 A	50	0336600000
QB 2 WI RA6 IS	27 A	50	0482700000
QB 3 WI RA6 IS	27 A	50	0482800000
QB 4 WI RA6 IS	27 A	50	0482900000
Width			
AP DK4	1.5 mm	20	0359260000
PS 2.3 RT	5.4 mm	20	0180400000
STB 8.5/D4/2.3/M2.5 AKZ		50	0215700000
TSCH 4 AKZ4	6 mm	100	0363360000

DEK 5/6

DKT 4 PT 100

4 mm²

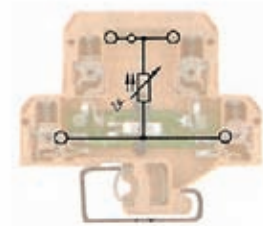

6 x 65 x 56.5
10 / 4
0.33...4

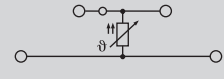

IEC	UL	CSA
250		
10		
4		
	/ 3	
	A3 / V2	
Rated connection		
0.5...4 / 0.5...4		
0.5...4 / 0.5...2.5		
0.4...0.7 Nm (M 2.5)		
6 / 0.6 x 3.5 mm		

Type	Qty.	Order No.
DKT 4/32 PT100	10	8014730000

Type	current	Qty.	Order No.
Q 2 AKZ4	32 A	50	0336400000
Q 3 AKZ4	32 A	50	0336500000
Q 4 AKZ4	32 A	50	0336600000
QB 2 WI RA6 IS	27 A	50	0482700000
QB 3 WI RA6 IS	27 A	50	0482800000
QB 4 WI RA6 IS	27 A	50	0482900000
Width			
AP DKT4 PA	1.5 mm	20	0687560000
PS 2.3 RT	5.4 mm	20	0180400000
STB 8.5/D4/2.3/M2.5 AKZ		50	0215700000
TSCH 4 AKZ4	6 mm	100	0363360000

DEK 5/6

Earth conductor isolating terminals

B

In hazardous area applications, the installation instructions and the rated data specifications for accessories given in the technical appendix must be followed.

Width/Length/height with TS35x7.5	mm
max. current / max. cond. cross-section	A/mm ²
Max. clamping range	mm ²

Technical data

Rated data	
Rated voltage	V
Rated current	A
Rated cross-section	mm ²
Rated impulse voltage / Pollution severity	kV/-
Gauge to IEC 60947-1 / UL94 Flammability class	
Approvals	

Clamped conductors (H05V/H07V)

solid / stranded	mm ²
flexible / Stranded wire with end ferrules	mm ²
Tightening torque range (clamping screw)	
Stripping length / Blade size	mm/-

Note

Ordering data

Version	
	40...60V~
Note	

Accessories

End bracket	
	Dark beige Wemid

SAKT E

6 mm²

green LED



19 x 65 x 53.5

27 / 10

0.5...10

IEC	UL	CSA
60		
27		
6		
	/ 3	
	A5 / 5VA	

Rated connection

0.5...10
0.5...6 / 0.5...6
0.8...1.6 Nm (M 3.5)
/ 4.0 x 0.8 mm

Type	Qty.	Order No.
SAKT E/32 2LD 60VAC	5	0699020000

Type	Width	Qty.	Order No.
EWK 1	9 mm	50	0206160000

Operating mode

SAKT E

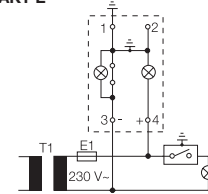

- Slide link is closed
- Auxiliary circuit is **earthed**
- Display is illuminated green

Test position

When measuring insulation resistance with voltages greater than UNom, the earth connection must first be disconnected.

SAKT E

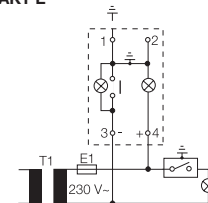

- Slide link is opened
- Auxiliary circuit is **not earthed**
- **No** earth fault
- Display illuminated green and red with reduced intensity
- Disconnected earth connection -> When measuring insulation resistance with voltages greater than UNom, the earth connection must be disconnected.

Operational malfunction

SAKT E

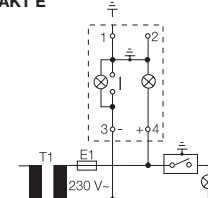

- Slide link is opened
- Auxiliary circuit is **not earthed**
- **Earth fault**
- Display is illuminated red

(see assortment in catalogue 7)

For detailed information on other accessories and applications, refer to the „Accessories“ section

To safe the test sockets use the SD-blade or bits with pilots!

SAK-Series combination foot TS 35 + TS 32

SAK-Series combination foot TS 35 + TS 32	Feed-through modular terminals	
	TS 35 + TS 32 / PA	C.2
	Stud terminals	C.6
	Fuse terminals	
	TS 35 + TS 32 / PA	C.7
	Earth conductor isolating terminals	C.8

Feed-through modular terminals

TS 35 + TS 32 / PA

In hazardous area applications, the installation instructions and the rated data specifications for accessories given in the technical appendix must be followed.

Width/Length/height with TS35x7.5	mm
max. current / max. cond. cross-section	A/mm ²
Max. clamping range	mm ²

Technical data

Rated data	
Rated voltage	V
Rated current	A
Rated cross-section	mm ²
Rated impulse voltage / Pollution severity	kV/-
Gauge to IEC 60947-1 / UL94 Flammability class	
Approvals	
Clamped conductors (H05V/H07V)	
solid / stranded	mm ²
flexible / Stranded wire with end ferrules	mm ²
Tightening torque range (clamping screw)	
Stripping length / Blade size	mm/-
2 conductors with same cross-section (H05V/H07V)	
solid / stranded	mm ²
flexible / Stranded wire with end ferrules	mm ²
Note	

Ordering data

Version	
	beige
	Blue
Note	

Accessories

Screwable cross-connection	
	2-pole
	3-pole
	4-pole
	10-pole
	Connecting sleeve
	Mounting screw
	Lock washer
Switchable link	
	Switchable link
	Connecting sleeve
	Mounting screw
Testing / Checking	
	Test plug
	Socket
End plate / Partition plate	
	beige
	Blue
	beige
	Blue
Small partition	
	Small partition
Cover / warning label	
	Cover / warning label
	Mounting screw (plastic)
Marking systems	
	(see assortment in catalogue 7)
	Marking tags
For detailed information on other accessories and applications, refer to the „Accessories“ section	

SAK 2.5/EN

2.5 mm²

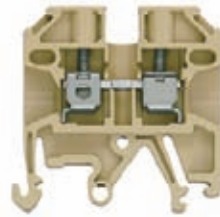

6.1 x 44.5 x 42.5
41 / 6
0.13...6

IEC 60947-7-1				Ex e ll Ex II 2 G D			
IEC	UL	CSA	EN 60079-7	IEC	UL	CSA	EN 60079-7
800	600	600	550	800	600	600	690
24	25	25	21	32	30	36	28
2.5	AWG 22...12	AWG 26...10	2.5	4	AWG 22...12	AWG 26...10	4
				8 / 3			
				A3 / V2			
				KEMA 97ATEX1798 U			
Rated connection							
0.5...6 / 0.5...4							
0.5...4 / 0.5...4							
0.4...0.6 Nm (M 2.5)							
10 / 0.6 x 3.5 mm							
...1.5							
With twin ferrules ZH 0.5 to ZH 1.5, rated voltage is 690 V.							

Type	Qty.	Order No.
SAK 2.5/EN	100	0218660000
SAK 2.5/EN BL	100	0218680000

Type	current	Qty.	Order No.
Q 2 SAK2.5	41 A	50	0337000000
Q 3 SAK2.5	41 A	50	0337100000
Q 4 SAK2.5	41 A	50	0337200000
Q 10 SAK2.5	41 A	20	0368700000
Width			
PS 2.3 RT	5.4 mm	20	0180400000
STB 8.5/5/2.3/M3 SAK2.5		50	0280600000
AP SAK2.5/35 + AST3+4	1.5 mm	20	0460560000
TW SAK2.5	2.5 mm	20	0302860000
TW SAK2.5 BL	1.5 mm	20	0302880000
TSCH 1	2 mm	100	0319160000
AD 3 SAK2.5		50	0297900000
BFSC M3X22 PA/RT		100	0128900000
DEK 5/6			

SAK 4/EN

4 mm²

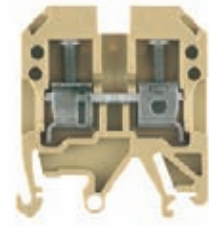

6.5 x 42 x 47.5
41 / 6
0.13...6

IEC 60947-7-1				Ex e ll Ex II 2 G D			
IEC	UL	CSA	EN 60079-7	IEC	UL	CSA	EN 60079-7
800	600	600	690	800	600	600	690
32	30	36	28	32	30	36	28
4	AWG 22...12	AWG 26...10	4	4	AWG 22...12	AWG 26...10	4
				8 / 3			
				A4 / V2			
				KEMA 97ATEX1798 U			
Rated connection							
0.5...6 / 0.5...4							
0.5...4 / 0.5...4							
0.5...1.0 Nm (M 3)							
12 / 0.6 x 3.5 mm							
1.5...1.5							
0.5...1.5							
With twin ferrules ZH 0.5 to ZH 2.5, rated voltage is 690 V.							

Type	Qty.	Order No.
SAK 4/EN	100	0467460000
SAK 4/EN BL	100	0467480000

Type	current	Qty.	Order No.
Q 2 SAK4	41 A	50	0336700000
Q 3 SAK4	41 A	50	0336800000
Q 4 SAK4	41 A	50	0336900000
Q 10 SAK4	41 A	20	0368800000
VL 2 SAK4	32 A	50	0197000000
VH 19/5/3.5 SAK4-16		50	0285100000
BFSC M3X25		100	0292500000
Width			
PS 2.3 RT	5.4 mm	20	0180400000
STB 14/D5/2.3/M3 SAK2.5		50	0168600000
AP SAK4-10	1.5 mm	20	0117960000
AP SAK4-10 BL	1.5 mm	20	0117980000
TW 4 SAK4-10	1.5 mm	20	0130160000
TW 4 SAK4-10 BL	1.5 mm	20	0130180000
TSCH 1	2 mm	100	0319160000
AD 4 SAK4		50	0285300000
BFSC M3X22 PA/RT		100	0128900000
DEK 5/6			

SAK 6/EN

6 mm²

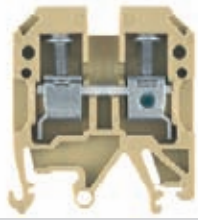

8 x 40 x 47.5
57 / 10
0.33...10

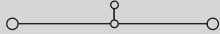

IEC 60947-7-1 Ex e II II 2 G D

IEC	UL	CSA	EN 60079-7
800	600	600	690
41	40	47	36
6	AWG 22...8	AWG 26...6	6
8 / 3			
A5 / V2			

KEMA 97ATEX1798 U

Rated connection

0.5...10 / 0.5...6
0.5...10 / 0.5...6
0.8...1.6 Nm (M 3.5)
12 / 4.0 x 0.8 mm

For AWG 8-7 and AWG 8-19, tightening torque is 1.21.4 Nm

Type	Qty.	Order No.
SAK 6/EN	100	0212860000
SAK 6/EN BL	100	0212880000

With AWG 6 and H07V-R10 conductors, an increased MD torque of 1.4 to 1.6 Nm should be used.

Type	current	Qty.	Order No.
Q 2 SAK6N	32 A	50	0456700000
Q 3 SAK6N	57 A	50	0456800000
Q 4 SAK6N	57 A	50	0456900000
Q 10 SAK6N	32 A	20	0457000000
VL 2 SAK6N/SAKT	32 A	50	0194700000
VH 19/5/3.5 SAK4-16		50	0285100000
BFSC M3X25		100	0292500000
Width			
PS 4 F.STB 4	7.6 mm	20	0299600000
STB 14/D6/4/M3 SAK10		50	0169900000
AP SAK4-10	1.5 mm	20	0117960000
AP SAK4-10 BL	1.5 mm	20	0117980000
TW 4 SAK4-10	1.5 mm	20	0130160000
TW 4 SAK4-10 BL	1.5 mm	20	0130180000
TSCH 1	2 mm	100	0319160000
AD 4 SAK6N		50	0196600000
BFSC M3X22 PA/RT		100	0128900000

DEK 5/8

When used with twin ferrules ZH 0.5 - ZH 4, the rated voltage is 690 V.

SAK 10/EN

10 mm²

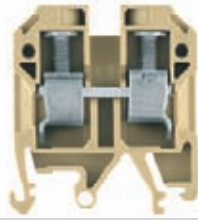

10 x 41.5 x 47.5
76 / 16
1.5...16

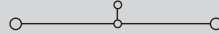

IEC 60947-7-1 Ex e II II 2 G D

IEC	UL	CSA	EN 60079-7
800	600	600	550
57	60	65	50
10	AWG 14...6	AWG 16...6	10
8 / 3			
B6 / V2			

KEMA 97ATEX1798 U

Rated connection

1.5...10 / 1.5...16
1.5...16 / 1.5...10
2.0...4.0 Nm (M 4)
12 / 1.0 x 5.5 mm

When used with twin ferrules ZH 0.5 - ZH 4, the rated voltage is 690 V.

Type	Qty.	Order No.
SAK 10/EN	100	0337660000
SAK 10/EN BL	100	1784410000

A higher torque of 2 to 2.4 Nm is necessary when using H07V-R16 and AWG 6 conductors.

Type	current	Qty.	Order No.
Q 2 SAK10	57 A	50	0457100000
Q 3 SAK10	57 A	50	0457200000
Q 4 SAK10	57 A	50	0457300000
Q 10 SAK10	57 A	20	0457400000
VL 2 SAK6N/SAKT	32 A	50	0194700000
VH 19/5/3.5 SAK4-16		50	0285100000
BFSC M3X25		100	0292500000
Width			
PS 4 F.STB 4	7.6 mm	20	0299600000
STB 14/D6/4/M3 SAK10		50	0169900000
AP SAK4-10	1.5 mm	20	0117960000
AP SAK4-10 BL	1.5 mm	20	0117980000
TW 4 SAK4-10	1.5 mm	20	0130160000
TW 4 SAK4-10 BL	1.5 mm	20	0130180000
TSCH 1	2 mm	100	0319160000
AD 4 SAK10		50	0178600000
BFSC M3X22 PA/RT		100	0128900000

DEK 5/5

SAK 16/EN

16 mm²

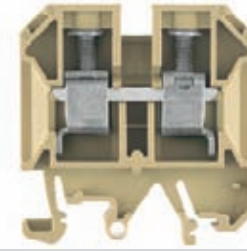

12 x 50 x 53.5
76 / 16
2.5...16

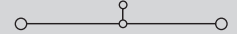

IEC 60947-7-1 Ex e II II 2 G D

IEC	UL	CSA	EN 60079-7
1000	600	600	690
76	80	87	66
16	AWG 12...4	AWG 14...6	16
8 / 3			
B6 / V2			

KEMA 97ATEX1798 U

Rated connection

2.5...16 / 4...16
4...16 / 4...16
2.0...4.0 Nm (M 4)
15 / 1.0 x 5.5 mm

Twin wire end ferrules ZH 2.5 - ZH 16 can be used.

Type	Qty.	Order No.
SAK 16/EN	50	0339760000
SAK 16/EN BL	50	1784390000

If QIs are aligned side by side, then a TW/AP must be used.

Type	current	Qty.	Order No.
Q 2 SAK16	76 A	50	0457500000
Q 3 SAK16	76 A	50	0457600000
Q 4 SAK16	76 A	50	0457700000
Q 10 SAK16	76 A	20	0457800000
VL 2 SAK16/SAKA	57 A	50	0135800000
VH 19/5/3.5 SAK4-16		50	0285100000
BFSC M3X25		100	0292500000
Width			
PS 4 F.STB 4	7.6 mm	20	0299600000
STB 14/D6/4/M3 SAK10		50	0169900000
AP SAK16	1.5 mm	20	0271160000
AP SAK16 BL	1.5 mm	20	0271180000
TSCH 1	2 mm	100	0319160000
AD 4 SAK16		50	0518200000
BFSC M3X22 PA/RT		100	0128900000

DEK 5/5

Feed-through modular terminals

TS 35 + TS 32 / PA

In hazardous area applications, the installation instructions and the rated data specifications for accessories given in the technical appendix must be followed.

Width/Length/height with TS35x7.5	mm
max. current / max. cond. cross-section	A/mm ²
Max. clamping range	mm ²

Technical data

Rated data	
Rated voltage	V
Rated current	A
Rated cross-section	mm ²
Rated impulse voltage / Pollution severity	kV/-
Gauge to IEC 60947-1 / UL94 Flammability class	
Approvals	
Clamped conductors (H05V/H07V)	
solid / stranded	mm ²
flexible / Stranded wire with end ferrules	mm ²
Tightening torque range (clamping screw)	
Stripping length / Blade size	mm/-
2 conductors with same cross-section (H05V/H07V)	
solid / stranded	mm ²
flexible / Stranded wire with end ferrules	mm ²
Note	

Ordering data

Version	
	beige
	Blue
Note	

Accessories

Screwable cross-connection	
	2-pole
	3-pole
	4-pole
	10-pole
	Connecting sleeve
	Mounting screw
	Lock washer
Switchable link	
	Switchable link
	Connecting sleeve
	Mounting screw
Testing / Checking	
	Test plug
	Socket
End plate / Partition plate	
	beige
	Blue
	beige
	Blue
Small partition	
	Small partition
Cover / warning label	
	Cover / warning label
	Mounting screw (plastic)
Marking systems	(see assortment in catalogue 7)
	Marking tags
For detailed information on other accessories and applications, refer to the „Accessories“ section	

SAK 35/EN

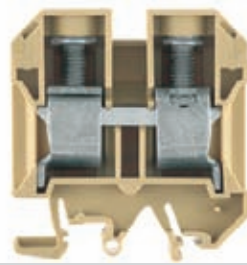
35 mm²

18 x 58 x 63.5

150 / 50

2.5...50

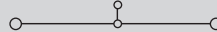

IEC 60947-1	Ex e ll			Ex ll	II 2 G D
IEC	UL	CSA	EN 60079-7		
1000	600	600	690		
125	115	145	109		
35	AWG 12...2	AWG 12...2	35		
			8 / 3		
			B8 / V2		
			KEMA 97ATEX1798 U		
Rated connection					
2.5...16 / 4...50					
2.5...35 / 2.5...35					
4.0...5.0 Nm (M 6)					
18 / 6.5 x 1.2 mm					
2.5...16 16					
2.5...16 / 2.5...16					
The tightening torque is 4.5 Nm for 16 - 50 mm ² and AWG 6 - 2/7 stranded conductors. Twin wire end ferrules ZH 2.5 - ZH 16 can be used.					

Type	Qty.	Order No.
SAK 35/EN	20	0339860000
SAK 35/EN BL	20	1784400000
It is possible to use twin ferrules with identical rated voltages (LAB 13090).		

Type	current	Qty.	Order No.
QL 2 SAK35	99 A	20	0123600000
QL 3 SAK35	99 A	20	0123700000
QL 4 SAK35	99 A	20	0123800000
QL 10 SAK35	99 A	20	0338600000
VH 17/8/5 SAK35		50	0267000000
BFSC M4X30		50	0267100000
SS M4 D 128-A 4		100	0136400000
Width			
PS 4 F.STB 4	7.6 mm	20	0299600000
STB 16/D7/4/M4 SAK35		50	0140200000
Width			
AP SAK35/TW SAK16	1.5 mm	10	0303660000
AP SAK35/TW SAK16 BL	1.5 mm	10	0303680000
TW SAK35	1.5 mm	20	0304360000
Width			
AD 4 SAK35		50	0178700000
BFSC M4X32 PA/RT		100	0129100000
Width			
DEK 5/5 / SCHT 7			
If QIs are aligned side by side, then a TW/AP must be used.			

DK 4 Q/EN

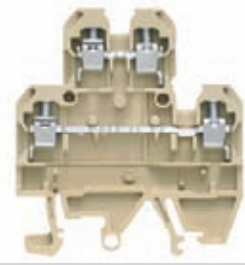
4 mm²

6.5 x 54 x 47.5

41 / 6

0.13...6

IEC 60947-1	Ex e ll			Ex ll	II 2 G D
IEC	UL	CSA	EN 60079-7		
500	600	600	690		
32	30	36	28		
4	AWG 22...12	AWG 26...10	4		
			8 / 3		
			A4 / V2		
			KEMA 97ATEX1798 U		
Rated connection					
0.5...6 / 0.5...4					
0.5...4 / 0.5...2.5					
0.5...1.0 Nm (M 3)					
12 / 0.6 x 3.5 mm					
1.5...1.5					
0.5...1.5					
With twin ferrules ZH 0.5 to ZH 2.5, rated voltage is 690 V.					

Type	Qty.	Order No.
DK 4 Q/EN	100	1907040000
DK 4 Q/EN BL	100	1907030000

Type	current	Qty.	Order No.
Q 2 SAK4	41 A	50	0336700000
Q 3 SAK4	41 A	50	0336800000
Q 4 SAK4	41 A	50	0336900000
Q 10 SAK4	41 A	20	0368800000
Width			
VL 2 SAK4	32 A	50	0197000000
VH 19/5/3.5 SAK4-16		50	0285100000
BFSC M3X25		100	0292500000
Width			
PS 2.3 RT	5.4 mm	20	0180400000
STB 14/D5/2.3/M3 SAK2.5		50	0168600000
Width			
AP SAK4-10	1.5 mm	20	0117960000
AP SAK4-10 BL	1.5 mm	20	0117980000
TW 4 SAK4-10	1.5 mm	20	0130160000
TW 4 SAK4-10 BL	1.5 mm	20	0130180000
Width			
TSCH 1	2 mm	100	0319160000
Width			
AD 4 SAK4		50	0285300000
BFSC M3X22 PA/RT		100	0128900000
Width			
DEK 5/6			

DK 4 QV/EN

4 mm²

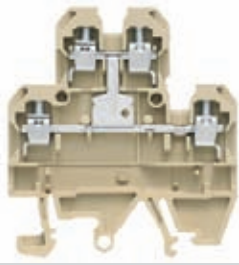

6.5 x 54 x 47.5

41 / 6

0.13...6

IEC 60947-7-1 Ex e II  II 2 G D

IEC	UL	CSA	EN 60079-7
500	600	600	690
32	30	36	28
4	AWG 22...12	AWG 26...10	4
8 / 3			
A4 / V2			
KEMA 97ATEX1798 U			

Rated connection

0.5...6 / 0.5...4

0.5...4 / 0.5...2.5

0.5...1.0 Nm (M 3)

12 / 0.6 x 3.5 mm

1.5...1.5

0.5...1.5

With twin ferrules ZH 0.5 to ZH 2.5, rated voltage is 690 V.

Type	Qty.	Order No.
DK 4 QV/EN	100	1907020000

Type	current	Qty.	Order No.
Q 2 SAK4	41 A	50	0336700000
Q 3 SAK4	41 A	50	0336800000
Q 4 SAK4	41 A	50	0336900000
Q 10 SAK4	41 A	20	0368800000
VL 2 SAK4		50	0197000000
VH 19/5/3.5 SAK4-16		50	0285100000
BFSC M3X25		100	0292500000
Width			
PS 2.3 RT	5.4 mm	20	0180400000
STB 14/D5/2.3/M3 SAK2.5		50	0168600000
AP SAK4-10	1.5 mm	20	0117960000
AP SAK4-10 BL	1.5 mm	20	0117980000
TW 4 SAK4-10	1.5 mm	20	0130160000
TW 4 SAK4-10 BL	1.5 mm	20	0130180000
TSCH 1	2 mm	100	0319160000
AD 4 SAK4		50	0285300000
BFSC M3X22 PA/RT		100	0128900000

DEK 5/6

C

Stud terminals

In hazardous area applications, the installation instructions and the rated data specifications for accessories given in the technical appendix must be followed.

Width/Length/height with TS35x7.5	mm
max. current / max. cond. cross-section	A/mm ²
Max. clamping range	mm ²

Technical data

Rated data	
Rated voltage	V
Rated current	A
Rated cross-section	mm ²
Rated impulse voltage / Pollution severity	kV/-
Gauge to IEC 60947-1 / UL94 Flammability class	
Approvals	
Clamped conductors (H05V/H07V)	
solid / stranded	mm ²
flexible / Stranded wire with end ferrules	mm ²
Tightening torque range (clamping screw)	
Stripping length / Blade size	mm/-
2 conductors with same cross-section (H05V/H07V)	
solid / stranded	-
flexible / Stranded wire with end ferrules	-
Note	

Ordering data

Version
Note

Accessories

End plate / Partition plate
beige
beige

ST 5

16 mm²

Screw thread M5

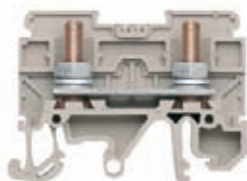

16.4 x 54.22 x 47.1

IEC	UL	CSA
800	600	
76	65	
16	AWG 12...10	
	8 / 3	
	/ V-0	
UL		
Rated connection		
Note		

Type	Qty.	Order No.
ST 5 PA/BE	20	0448360000

Type	Width	Qty.	Order No.
AP ST5 PPO/SW		10	0447240000
TW ST5 PA/BE		10	0477660000

STL 5

16 mm²

Screw thread M5

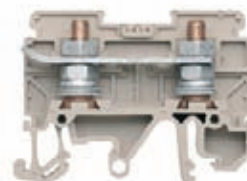

16.4 x 54.22 x 47.1

IEC	UL	CSA
800	600	
76	65	
16	AWG 12...10	
	8 / 3	
	/ V-0	
UL		
Rated connection		
Note		

Type	Qty.	Order No.
STL 5	20	0448460000

Type	Width	Qty.	Order No.
AP ST5 PPO/SW		10	0447240000
TW ST5 PA/BE		10	0477660000

(see assortment in catalogue 7)

For detailed information on other accessories and applications, refer to the „Accessories“ section

TS 35 + TS 32 / PA

ASK 1

4 mm²

KDKS 1 m. LED

4 mm²

With or without LED

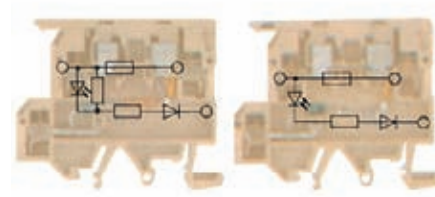
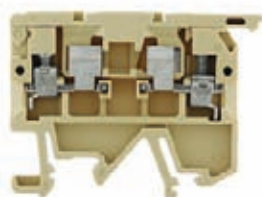

In hazardous area applications, the installation instructions and the rated data specifications for accessories given in the technical appendix must be followed.

Width/Length/height with TS35x7.5	mm
max. current / max. cond. cross-section	A/mm ²
Max. clamping range	mm ²

8.1 x 58 x 43	
6.3 / 4	
0.13...4	

8 x 62.75 x 55.5	
6.3 / 4	
0.5...4	

Technical data

Rated data	
Rated voltage	V
Rated current	A
Rated cross-section	mm ²
Rated impulse voltage / Pollution severity	kV/-
Gauge to IEC 60947-1 / UL94 Flammability class	Approvals
Clamped conductors (H05V/H07V)	
solid / stranded	mm ²
flexible / Stranded wire with end ferrules	mm ²
Tightening torque range (clamping screw)	
Stripping length / Blade size	mm/-
Note	

IEC	UL	CSA
500		
6.3		
4	AWG 22...12	AWG 26...12
	6 / 3	
	A3 / V2	
Rated connection		
0.5...4		
0.5...4 / 0.5...4		
0.6...0.8 Nm (M 3)		
9 / 0.6 x 3.5 mm		
Note: max. conductor size = 2.5 mm ² when using the cross-connection. Twin wire-end ferrules ZH 0.5 - ZH 2.5 can be used.		

IEC	UL	CSA
500		
6.3		
4		
	/ 3	
	A3 / V2	
Rated connection		
0.5...4		
0.5...4 / 0.5...4		
0.5...0.8 Nm (M 3)		
9 / 0.6 x 3.5 mm		
Note: max. conductor size = 2.5 mm ² when using the cross-connection.		

Ordering data

Version	
	500 V AC/DC
	With LED 230 V AC
	With LED 230 V DC
	With LED 115 V AC
	With LED 115 V DC
	With LED 60 V DC
	With LED 48 V AC
	With LED 48 V DC
	With LED 24 V AC
	With LED +- 24 V DC
Note	

Type	Qty.	Order No.
ASK 1/EN	100	0474560000
ASK 1/EN LD 1D 230VAC	25	0225760000
ASK 1/EN LD 120K 230VDC	25	0225660000
ASK 1/EN LD 1D 115VAC	25	0225560000
ASK 1/EN LD 56K 115VDC	25	0225460000
ASK 1/EN LD 33K 60VDC	25	0226460000
ASK 1/EN LD 1D 48VAC	25	0225360000
ASK 1/EN LD 27K 48VDC	25	0225260000
ASK 1/EN LD 1D 24VAC	25	0222860000
ASK 1/EN LD 15K 24VDC	25	0222760000

Type	Qty.	Order No.
KDKS1/EN LD 230VAC	25	8148910000
KDKS1/EN LD 115VAC	25	8142840000
KDKS1/EN LD 48 VAC	25	8148920000
KDKS1/EN LD 24 VAC	25	8148930000
KDKS1/EN LD 24VDC	25	8146450000

Accessories

Screwable cross-connection	
	2-pole
	3-pole
	4-pole
End plate / Partition plate	

Type	current	Qty.	Order No.
QB 2 WI RA8 IS	27 A	50	0461100000
QB 3 WI RA8 IS	27 A	50	0461200000
QB 4 WI RA8 IS	27 A	50	0461300000
Width			
AP ASK1	1.5 mm	20	0380360000

Type	current	Qty.	Order No.
QB 2 WI RA8 IS	27 A	50	0461100000
QB 3 WI RA8 IS	27 A	50	0461200000
QB 4 WI RA8 IS	27 A	50	0461300000
Width			
AP KDKS1 EN		20	9503340000

Marking systems (see assortment in catalogue 7)
Marking tags

DEK 5/8 / SCHT 7

DEK 5/8

For detailed information on other accessories and applications, refer to the „Accessories“ section

Earth conductor isolating terminals

SAKA 10/EN

10 mm²

Neon lamp



In hazardous area applications, the installation instructions and the rated data specifications for accessories given in the technical appendix must be followed.

Width/Length/height with TS35x7.5	mm
max. current / max. cond. cross-section	A/mm ²
Max. clamping range	mm ²

24 x 82 x 61.5

47 / 10

0.5...10

Technical data

Rated data

Rated voltage	V
Rated current	A
Rated cross-section	mm ²
Rated impulse voltage / Pollution severity	kV/-
Gauge to IEC 60947-1 / UL94 Flammability class	/ 5VA
Approvals	

Clamped conductors (H05V/H07V)

solid / stranded	mm ²
flexible / Stranded wire with end ferrules	mm ²
Tightening torque range (clamping screw)	
Stripping length / Blade size	mm/-

Note

IEC	UL	CSA
24		
47		
10		

Rated connection

0.5...10
0.5...10 / 0.5...10
1.2...2.2 Nm
12 /

Tightening torque 1.6 Nm for 10 mm² stranded wire.

Ordering data

Version

24 V~
230 V~

Note

Accessories

End bracket

Dark beige Wemid
Dark beige Wemid

Type	Qty.	Order No.
SAKA 10/EN 2GL 24VUC	5	8150150000
SAKA 10/EN 2GL 230VAC	5	8109130000

Type	Width	Qty.	Order No.
EWK 1	9 mm	50	0206160000
EW 35	8.5 mm	50	0383560000

(see assortment in catalogue 7)

For detailed information on other accessories and applications, refer to the „Accessories“ section

Width with AP = 27 mm

Operating mode

SAKA 10

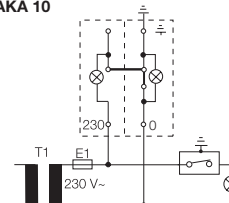

- Slide link is closed
- Auxiliary circuit is **earthed**
- Display is illuminated green

Test position

When measuring insulation resistance with voltages greater than UNom, the earth connection must first be disconnected.

SAKA 10

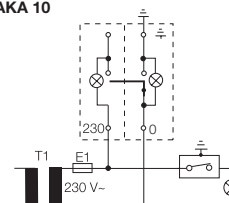

- Slide link is opened
- Auxiliary circuit is **not earthed**
- **No** earth fault
- Display illuminated green and red with reduced intensity
- Disconnected earth connection -> When measuring insulation resistance with voltages greater than UNom, the earth connection must be disconnected.

Operational malfunction

SAKA 10

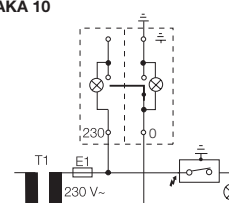

- Slide link is opened
- Auxiliary circuit is **not earthed**
- **Earth fault**
- Display is illuminated red

SAK-Series for special applications

SAK-Series for special applications	Modular terminals for high-temperature applications	
	TS 32 / Ceramic	D.2
	Modular terminals for nuclear power stations	
	Overview	D.4
	TS 32 / EP	D.6

Modular terminals for high-temperature applications

TS 32 / Ceramic

In hazardous area applications, the installation instructions and the rated data specifications for accessories given in the technical appendix must be followed.

Width/Length/height with TS35x7.5	mm
max. current / max. cond. cross-section	A/mm ²
Max. clamping range	mm ²

Technical data

Rated data

Rated voltage	V
Rated current	A
Rated cross-section	mm ²
Rated impulse voltage / Pollution severity	kV/-
Gauge to IEC 60947-1 / UL94 Flammability class	
Approvals	

Clamped conductors (H05V/H07V)

solid / stranded	mm ²
flexible / Stranded wire with end ferrules	mm ²
Tightening torque range (clamping screw)	
Stripping length / Blade size	mm/-

2 conductors with same cross-section (H05V/H07V)

solid / stranded	mm ²
flexible / Stranded wire with end ferrules	mm ²

Note

Ordering data

Version

white

Note

Accessories

Screwable cross-connection

2-pole	
3-pole	
4-pole	
10-pole	
Connecting sleeve	
Mounting screw	

End plate / Partition plate

white

SAKK 4 Sn

4 mm²

Tin Plated for high continuous temperatures
- max. 250 °C

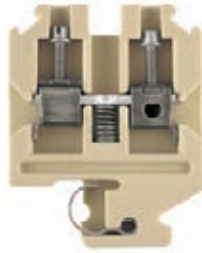

8 x 40 x 53
41 / 6
0.33...6

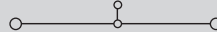
IEC 60947-7-1 Ex e ll  II 2 G D

IEC	UL	CSA	EN 60079-7
800	600		275
32	30		28
4			4
8 / 3			
A4 / 5VB			

 SIRA 03ATEX3425 U

Rated connection

0.5...6
0.5...4 / 0.5...4
0.5...1.0 Nm (M 3)
10 / 0.6 x 3.5 mm

0.5...1.5
0.5...1.5 / 0.5...1.5

Do not use mechanical or electrical torque screwdrivers for fastening the conductor.

Type	Qty.	Order No.
SAKK 4 KER/WS	25	1598080000

Type	current	Qty.	Order No.
QL 2 SAKK 4 TIN	32 A	100	9509420000
QL 3 SAKK 4 TIN	32 A	100	9509430000
QL 4 SAKK 4 TIN	57 A	50	9509440000
QL 10 SAKK 4 TIN	41 A	20	9509450000
VH 13.5 SAKK 4		100	9509460000
KISC M3X20.5/10 EK4		100	0303000000
Width			
AP SAKK4/10 KER/WS	3 mm	10	9502630000

Twin wire-end ferrules ZH 0.5 - ZH 2.5 can be used. End bracket MEW 1/32 order no. 0445600000; locking pin SST3 order no. 0152700000

SAKK 4 Ni

4 mm²

Nickel coating for high-temperature applications
- max. 750°C for 3 hours

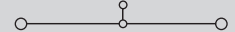

8 x 40 x 53
41 / 6
0.33...6

IEC 60947-7-1 Ex e ll  II 2 G D

IEC	UL	CSA	EN 60079-7
800	600		275
32	30		28
4			4
8 / 3			
A4 / 5VB			

 SIRA 03ATEX3425 U

Rated connection

0.5...6
0.5...4 / 0.5...4
0.5...1.0 Nm (M 3)
10 / 0.6 x 3.5 mm

0.5...1.5
0.5...1.5 / 0.5...1.5

Do not use mechanical or electrical torque screwdrivers for fastening the conductor.

Type	Qty.	Order No.
SAKK 4	25	9502600000

Type	current	Qty.	Order No.
QL 2 SAKK 4	32 A	100	9502540000
QL 3 SAKK 4	32 A	100	9502550000
QL 4 SAKK 4	32 A	50	9502560000
QL 10 SAKK 4	41 A	20	9502570000
VH 13.5 SAKK 4		100	9502580000
KISC M3X20.5/10 EK4		100	0303000000
Width			
AP SAKK4/10 KER/WS	3 mm	10	9502630000

End Barrier MEW 1/32 order no. 0445600000; Locking pin SST3 order no. 0152700000

(see assortment in catalogue 7)

For detailed information on other accessories and applications, refer to the „Accessories“ section

SAKK 10 Sn

10 mm²

Tin Plated for high continuous temperatures
- max. 250 °C



11.5 x 40 x 53
76 / 16
1.5...16

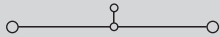

IEC 60947-7-1 Ex e II II 2 G D

IEC	UL	CSA	EN 60079-7
800	600		275
57	55		50
10			10
8 / 3			
B6 / 5VB			

SIRA 03ATEX3425 U

Rated connection

1.5...16 / 1.5...16
1.5...16 / 1.5...10
2.0...4.0 Nm (M 4)
12 / 1.0 x 5.5 mm

Do not use mechanical or electrical torque screwdrivers for fastening the conductor.

Type	Qty.	Order No.
SAKK 10 KER/WS	25	1598090000

Type	current	Qty.	Order No.
QL 2 SAKK 10 TIN		100	9509470000
QL 3 SAKK 10 TIN		50	9509480000
QL 4 SAKK 10 TIN		50	9509490000
QL 10 SAKK 10 TIN		20	9509500000
VH 12.5 SAKK10		50	9509510000
KISC M3X20.5/10 EK4		100	0303000000
Width			
AP SAKK4/10 KER/WS	3 mm	10	9502630000

End barrier MEW 1/32 order no. 0445600000;
Locking pin SST3 order no. 0152700000

SAKK 10 Ni

10 mm²

Nickel coating for high-temperature applications
- max. 750°C for 3 hours



11.5 x 40 x 53
76 / 16
1.5...16

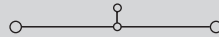

IEC 60947-7-1 Ex e II II 2 G D

IEC	UL	CSA	EN 60079-7
800	600		275
57	55		50
10			10
8 / 3			
B6 / 5VB			

SIRA 03ATEX3425 U

Rated connection

1.5...16 / 1.5...16
1.5...16 / 1.5...10
2.0...4.0 Nm (M 4)
12 / 1.0 x 5.5 mm

Do not use mechanical or electrical torque screwdrivers for fastening the conductor.

Type	Qty.	Order No.
SAKK 10	25	9502610000

Type	current	Qty.	Order No.
QL 2 SAKK 10	57 A	100	9502650000
QL 3 SAKK 10	57 A	50	9502660000
QL 4 SAKK 10	57 A	50	9502670000
QL 10 SAKK 10	57 A	20	9502680000
VH 12.5 SAKK10		50	9502690000
KISC M3X20.5/10 EK4		100	0303000000
Width			
AP SAKK4/10 KER/WS	3 mm	10	9502630000

End barrier MEW 1/32 order no. 0445600000;
Locking pin SST3 order no. 0152700000

D

Terminal Blocks for the Containment Areas of Nuclear Power Generating Stations

NEQ Nuclear Environmental Qualification	
Test Report	
REPORT NO.	42342-1 REV. 15/01/93
WYLE JOB NO.	42342
CUSTOMER	92 3048/999/QW
P. O. NO.	
PAGE 1 OF	1317 PAGE REPORT A
DATE	August 26, 1993
SPECIFICATION (S)	See references in Paragraph 3.8
1.0 CUSTOMER	Weidmüller
ADDRESS	KRassaustrasse 16, Postfach 2040, 5940 Detmold, Germany
2.0 TEST SPECIMEN	Terminal Blocks
3.0 MANUFACTURER	Weidmüller
4.0 SUMMARY	A Nuclear Environmental Qualification Test Program was performed on 67 test groups of various Weidmüller terminal blocks in accordance with Wyle Laboratories Nuclear Environmental Qualification Plan, 42341 00, Revision A. The last program was performed October 2, 1992 through June 25, 1993.
11a2	
STATE OF ALABAMA OFFICE OF THE COMMISSIONER JAMES T. HANLON, III Commissioner	WYLE LABORATORIES SCIENTIFIC SERVICES & SYSTEMS GROUP HUNTSVILLE, ALABAMA

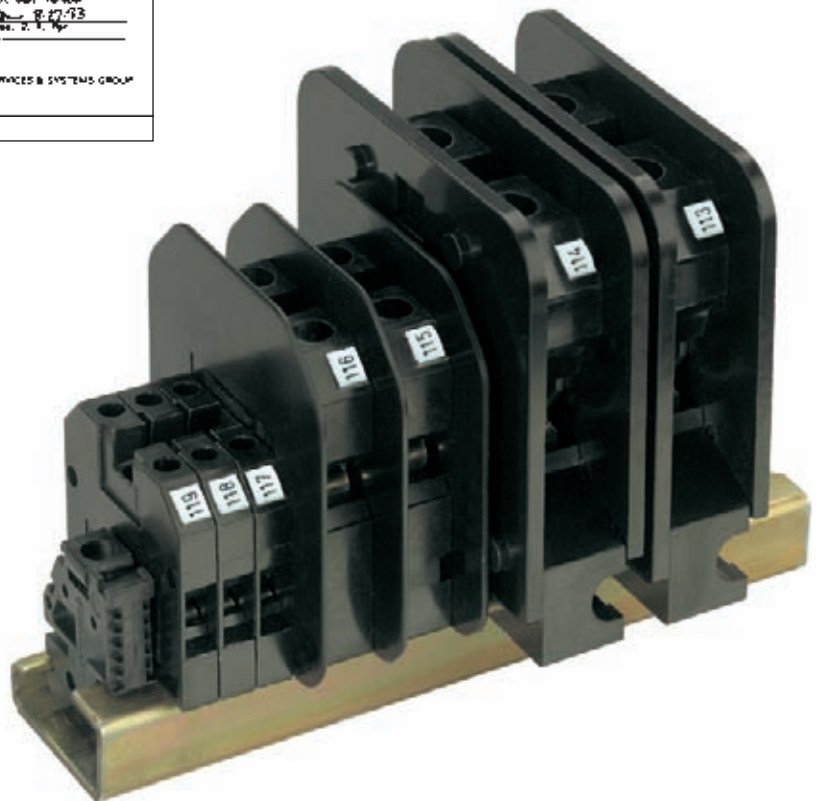
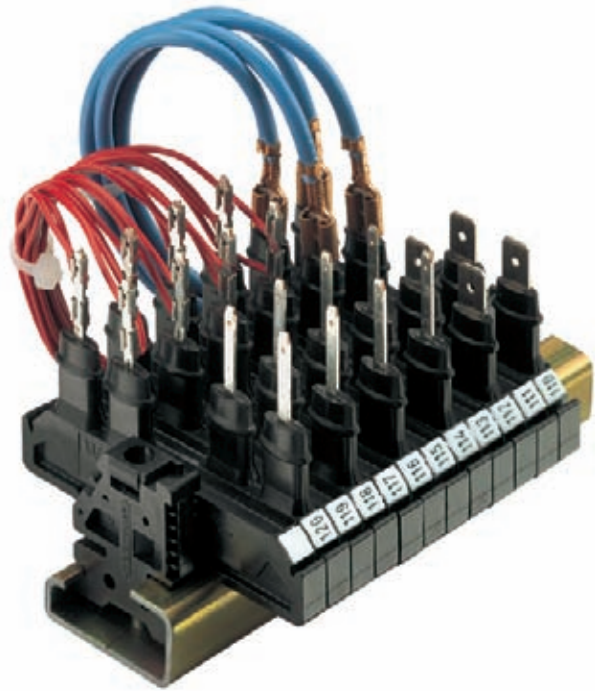

High standards are set for products used in containment areas of nuclear power generating stations. Years of radioactive radiation must not lead to failure. Signals must be transmitted faultlessly in the case of accidents, for example, steam escaping after a coolant pipe burst.

In particular, steam enveloping the terminal blocks could lead to problems. Unsuitable terminal blocks cause leakage currents, which lead to signal distortions. That is why only products which have been approved in accordance with IEEE Class 1 E are allowed to be installed in containment areas.

The special feature of the tests carried out using Weidmüller's terminal blocks is that not only was the insulation resistance measured following an accident simulation, but that the leakage current was recorded during the LOCA test (Loss of Coolant Accident).

Weidmüller also offers for these applications a choice of products made from the special epoxy resin material EP with inorganic filler, which meets the demands for high standards.

The comprehensive test results produced by the Wyle Laboratories enable the regulatory body to judge Weidmüller's products for containment areas Class 1 E (accident simulation test profile 4) and for general use (accident simulation test profile 1) in nuclear generating stations.

- Basis:** **IEEE 323 – 1983**
 "Qualifying class 1 E Equipment for Nuclear Power Generating Stations"
IEE 344 – 1987
 "Recommended Practices for Seismic Qualification of Class 1 E Equipment for Nuclear Power Generating Stations"
Agency: Wyle Laboratories, Huntsville, Alabama, USA
Period: 1992 – 1993

The basis for the qualification statement are the standards laid down in the IEEE that comprise the following product cycles:

1. Functional Test/Initial Values

- Insulation resistance
- Volume resistances

2. Radioactive Aging

- Total dose: 220 Mrad
- Dose rate: 1 Mrad/h
- Volume resistance after contamination

3. Thermal aging equivalent to 40 years of operation at ambient temperature

- 32 °C = 90 °F outside of containment area
- 65 °C = 150 °F within the containment area
- Accelerated aging
- Insulation resistance after contamination

4. Earthquake Simulation

- 5 OBE, 1 SSE test in 3 axes
- Monitoring of the electrical functions

5. Accident Simulation

- Inside and outside of the containment area
- Monitoring of leakage currents for different applications during the accident simulation
- Insulation resistance after contamination

6. Functional Test/Final Values

- Volume resistance
- Optical inspection

As well as the special terminal blocks for the containment areas, which correspond to the standards according to Class 1 E, Weidmüller has subjected a range of standard terminal blocks to intensive tests in accordance with test profile 1. They all fully meet the demands set for terminal blocks for outside of restricted areas.

Accident Simulation Test Profile 1 Typical PWR Outside Containment Simulation

During the 4-hour test, saturated steam is fed to the temperature control. This simulation is carried out at atmospheric pressure.

Accident Simulation Test Profile 4 Typical PWR Inside Containment Simulation

During the 29-hour test, saturated steam is fed to the temperature control. In the period from the 3rd to 24th hour, the test circuit that is coated with a chemical spray is alternatively coated with a demineralizing spray. This simulation is carried out at an increased pressure of a maximum of 4500 hPa (4.5 bar).

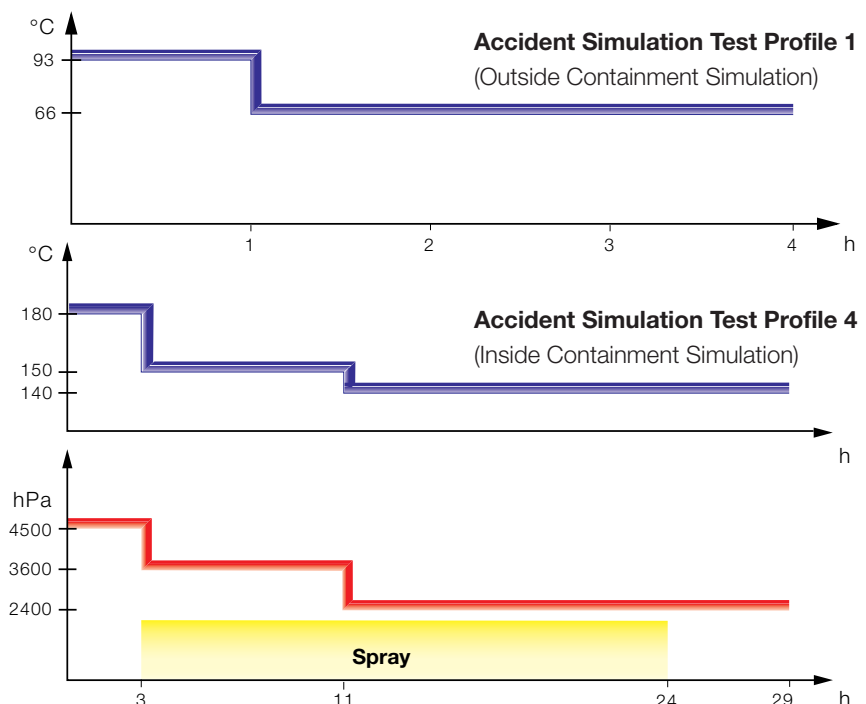

Modular terminals for nuclear power stations

TS 32 / EP

In hazardous area applications, the installation instructions and the rated data specifications for accessories given in the technical appendix must be followed.

Width/Length/height with TS35x7.5	mm
max. current / max. cond. cross-section	A/mm ²
Max. clamping range	mm ²

Technical data

Rated data	
Rated voltage	V
Rated current	A
Rated cross-section	mm ²
Rated impulse voltage / Pollution severity	kV/-
Gauge to IEC 60947-1 / UL94 Flammability class	
Approvals	
Clamped conductors (H05V/H07V)	
solid / stranded	mm ²
flexible / Stranded wire with end ferrules	mm ²
Tightening torque range (clamping screw)	
Stripping length / Blade size	mm/-
Note	

Ordering data

Version	
	black
	Black
Note	

Accessories

Screwable cross-connection	
	2-pole
	3-pole
	4-pole
	10-pole
Testing / Checking	
	Test plug
	Socket
End plate / Partition plate	
	black

Marking systems	(see assortment in catalogue 7)
	Marking tags
For detailed information on other accessories and applications, refer to the „Accessories“ section	

SAKH 4

4 mm²

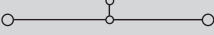
6.5 x 40 x 51.5	
41 / 6	
0.13...6	

IEC 60947-7-1				Ex e ll  II 2 G D	
IEC	UL	CSA	EN 60079-7		
800			550		
32			28		
4			4		
		8 / 3			
		A4 / V-0			
		KEMA 97ATEX1798 U			
Rated connection					
0.5...6 / 0.5...4					
0.5...4 / 0.5...4					
0.5...1.0 Nm (M 3)					
12 / 0.6 x 3.5 mm					
When using the twin wire-end ferrules ZH 0.5 - ZH 2.5 without a partition wall, the rated voltage is 690 V.					

Type	Qty.	Order No.
SAK 4 EP/SW	100	0128300000
SAK 4 CUN/EP/SW	100	0168800000

Type	current	Qty.	Order No.
Q 2 SAK4	41 A	50	0336700000
Q 3 SAK4	41 A	50	0336800000
Q 4 SAK4	41 A	50	0336900000
Q 10 SAK4	41 A	20	0368800000
Width			
PS 4 F.STB 4	7.6 mm	20	0299600000
STB 14/D5/2.3/M3 SAK2.5		50	0168600000
Width			
TW SAK4-10 EP/SW	2.5 mm	20	0130100000

DEK 5/5	
End bracket from EP: 0693060000 EWK 1PPS/SW.	

SAKH 6

10 mm²

14 x 57 x 76.5	
76 / 16	
0.5...16	

IEC 60947-7-1		
IEC	UL	CSA
1000		
57		
10		
		8 / 3
		B6 / V-0
KEMA 97ATEX1798 U		
Rated connection		
0.5...16 / 0.5...16		
0.5...10 / 0.5...10		
1.2...2.4 Nm (M 4)		
12 / 1.0 x 5.5 mm		
Twin wire-end ferrules ZH 75 - ZH 6 can be used.		

Type	Qty.	Order No.
SAKH 6 EP/SW	50	0126600000

Type	Qty.	Order No.
Width		
AP SAKH6/10 EP/SW	4 mm	20 0131700000

DEK 5/5	
End bracket from EP: 0693060000 EWK 1PPS/SW.	

Modular terminals for nuclear power stations

TS 32 / EP

In hazardous area applications, the installation instructions and the rated data specifications for accessories given in the technical appendix must be followed.

Width/Length/height with TS35x7.5	mm
max. current / max. cond. cross-section	A/mm ²
Max. clamping range	mm ²

Technical data

Rated data	
Rated voltage	V
Rated current	A
Rated cross-section	mm ²
Rated impulse voltage / Pollution severity	kV/-
Gauge to IEC 60947-1 / UL94 Flammability class	
Approvals	
Clamped conductors (H05V/H07V)	
solid / stranded	mm ²
flexible / Stranded wire with end ferrules	mm ²
Tightening torque range (clamping screw)	
Stripping length / Blade size	mm/-
Note	

Ordering data

Version
black
Black
Note

Accessories

Screwable cross-connection
2-pole
3-pole
4-pole
10-pole
Testing / Checking
Test plug
Socket
End plate / Partition plate
black

Marking systems	(see assortment in catalogue 7)
	Marking tags
For detailed information on other accessories and applications, refer to the „Accessories“ section	

KMVF LI 6.3 EP/SW

2.5 mm²



IEC	UL	CSA
800		
16		
2.5		
	8 / 3	
	/ V-0	
Rated connection		
0.5...2.5		
0.5...2.5 / 0.5...2.5		
250 V rated voltage for standard straight alignment and 800 V rated voltage for staggered alignment with alternating KMVF LI and KMVF RE.		

Type	Qty.	Order No.
KMVF LI 6.3 EP/SW	50	0249100000

Type	Qty.	Order No.

DEK 5/5

KMVF RE 6.3 EP/SW

2.5 mm²

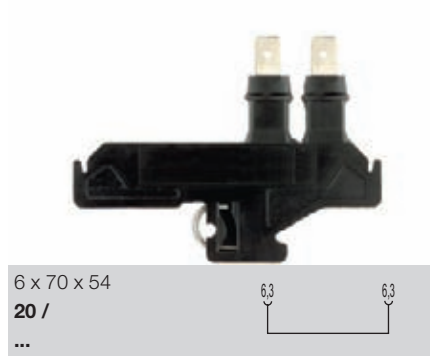

IEC	UL	CSA
800		
16		
2.5		
	8 / 3	
	/ V-0	
Rated connection		
0.5...2.5		
0.5...2.5 / 0.5...2.5		
250 V rated voltage for standard straight alignment and 800 V rated voltage for staggered alignment with alternating KMVF LI and KMVF RE.		

Type	Qty.	Order No.
KMVF RE 6.3 EP/SW	50	0249200000

Type	Qty.	Order No.

DEK 5/5

KMVT LI 2.4 EP/SW

0.5 mm²



6 x 70 x 62
/ ...
24 24

IEC	UL	CSA
800		
12		
0.5		
	8 / 3	
	/ V-0	
Rated connection		
0.5...2.5		
0.5...2.5 / 0.5...2.5		
250 V rated voltage for standard straight alignment and 800 V rated voltage for staggered alignment with alternating KMVT LI and KMVT RE.		

Type	Qty.	Order No.
KMVT LI 2.4 EP/SW	50	0249300000

Type	Qty.	Order No.

DEK 5/5

KMVT RE 2.4 EP/SW

0.5 mm²



6 x 70 x 62
/ ...
24 24

IEC	UL	CSA
800		
12		
0.5		
	8 / 3	
	/ V-0	
Rated connection		
0.5...2.5		
0.5...2.5 / 0.5...2.5		
250 V rated voltage for standard straight alignment and 800 V rated voltage for staggered alignment with alternating KMVT LI and KMVT RE.		

Type	Qty.	Order No.
KMVT RE 2.4 EP/SW	50	0249400000

Type	Qty.	Order No.

DEK 5/5

PPT/35

6 mm²



15 x 138 x 77
30 / 10
0.5...10

IEC 60947-7-1

IEC	UL	CSA
1500		
30		
6		
	15 / 3	
	/ V-0	
Rated connection		
0.5...10 / 0.5...10		
1.5...6 / 1.5...4		
12 /		

Type	Qty.	Order No.
PPT/35	10	3835020000

Type	Qty.	Order No.

Width		
PS 4 F.STB 4	7.6 mm	20 0299600000
STB 17/D6/4/M4 SAKC10		50 0147100000
AP PPT/35	3 mm	10 3835120000

DEK 5/5
The isolating plug (3835360000) may only be pulled out with the removal tool (3835260000). Insulated mounting rail (0514300000).

D

AKZ-Series TS 15

AKZ-Series TS 15

Mini Modular Terminals

Feed-through terminal / Disconnect-test terminal TS 15 / PA	E.2
Modular PE terminals TS 15 / PA	E.4
Fuse terminals TS 15 / PA	E.6
With push-on connection TS 15 / PA	E.8
With solder connection TS 15 / PA	E.10
With solder connection TS 15 / KrG	E.12
With Termi-Point / Wire-Wrap connection TS 15 / PA	E.13

Mini modular terminals

**Feed-through terminal
Disconnect-test terminal
TS 15 / PA**

In hazardous area applications, the installation instructions and the rated data specifications for accessories given in the technical appendix must be followed.

Width/Length/height with TS35x7.5	mm
max. current / max. cond. cross-section	A/mm ²
Max. clamping range	mm ²

Technical data

Rated data	
Rated voltage	V
Rated current	A
Rated cross-section	mm ²
Rated impulse voltage / Pollution severity	kV/-
Gauge to IEC 60947-1 / UL94 Flammability class	
Approvals	
Clamped conductors (H05V/H07V)	
solid / stranded	mm ²
flexible / Stranded wire with end ferrules	mm ²
Tightening torque range (clamping screw)	
Stripping length / Blade size	mm/-
2 conductors with same cross-section (H05V/H07V)	
solid / stranded	mm ²
flexible / Stranded wire with end ferrules	mm ²
Note	

Ordering data

Version	
	Dark beige Wemid (PA)
	Blue Wemid (PA)
	beige (PA)
	Blue (PA)
Note	

Accessories

Screwable cross-connection	
	2-pole
	3-pole
	4-pole
	10-pole
End plate / Partition plate	
	beige
	Dark beige Wemid
	Blue Wemid
	Dark beige Wemid
	Blue Wemid
Small partition	
	Small partition
End bracket	
	Dark beige Wemid
Testing / Checking	
	Test plug
	Socket

Marking systems	
	(see assortment in catalogue 7)
	Marking tags
For detailed information on other accessories and applications, refer to the „Accessories“ section	



AKZ 1.5

1.5 mm²

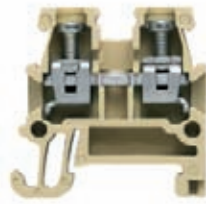
Feed-through terminal

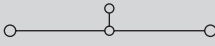

5.1 x 24.8 x 25	
24 / 2.5	
0.21...2.5	

IEC 60947-7-1				Ex e ll  II 2 G D			
IEC	UL	CSA	EN 60079-7	IEC	UL	CSA	EN 60079-7
250	150	300	176	250	300	300	176
17.5	15	10	10	24	10	10	15
1.5	AWG 22...14	AWG 24...16	1.5	2.5	AWG 22...12	AWG 26...10	2.5
				4 / 3			
				A1 / V2			
				SIRA 02ATEX3001 U			
Rated connection							
0.5...2.5 / 1.5...1.5							
0.5...1.5 / 0.5...1.5							
0.4...0.6 Nm (M 2.5)							
7 / 3.0 x 0.5 mm							
0.5...1							
0.5...1 / 0.5...0.75							
Note							

Type	Qty.	Order No.
AKZ 1.5	100	0340460000
AKZ 1.5 BL	100	0340480000
Note		
AKZ 1.5 order Nos 0340460000 and 0340480000 made from PA with V2 flammability rating to UL 94		

Type	current	Qty.	Order No.
Q 2 AKZ1.5	24 A	50	0368200000
Q 3 AKZ1.5	24 A	50	0368300000
Q 4 AKZ1.5	24 A	50	0368400000
Q 10 AKZ1.5	24 A	20	0368500000
Width			
AP AKZ1.5	1.5 mm	50	0340560000
AP AKZ1.5 BL	1.5 mm	50	0340580000
TW AKZ2.5	0.5 mm	20	0318560000
TW AKZ2.5 BL	0.5 mm	20	0318580000
Small partition			
EW 15	10 mm	50	0382860000
Testing / Checking			
PS 2.3 RT	5.4 mm	20	0180400000
STB 8.5/D4/2.3/M2.5 AKZ		50	0215700000

Marking systems	
	DEK 5/5
For detailed information on other accessories and applications, refer to the „Accessories“ section	



AKZ 2.5

2.5 mm²

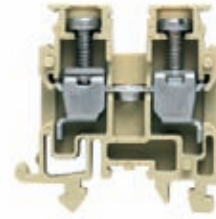
Feed-through terminal

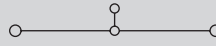

5.1 x 25.5 x 26.5	
32 / 4	
0.13...4	

IEC 60947-7-1				Ex e ll  II 2 G D			
IEC	UL	CSA	EN 60079-7	IEC	UL	CSA	EN 60079-7
250	300	300	176	250	300	300	176
24	10	10	15	24	10	10	15
2.5	AWG 22...12	AWG 26...10	2.5	2.5	AWG 22...12	AWG 26...10	2.5
				4 / 3			
				A3 / V2			
				SIRA 02ATEX3001 U			
Rated connection							
0.5...4 / 1.5...2.5							
0.5...2.5 / 0.5...2.5							
0.4...0.6 Nm (M 2.5)							
7 / 3.0 x 0.5 mm							
0.5...1.5							
0.5...1.5 / 0.5...1.5							
Note							

Type	Qty.	Order No.
AKZ 2.5	100	0697160000
AKZ 2.5 BL	100	0697180000
Note		
AKZ 2.5 order Nos 0697160000 and 0697180000 made from PA with V2 flammability rating to UL 94		

Type	current	Qty.	Order No.
Q 2 AKZ1.5	24 A	50	0368200000
Q 3 AKZ1.5	24 A	50	0368300000
Q 4 AKZ1.5	24 A	50	0368400000
Q 10 AKZ1.5	24 A	20	0368500000
Width			
AP AKZ2.5	2.5 mm	50	0697360000
AP AKZ2.5 BL	2.5 mm	50	0697380000
TW AKZ2.5	0.5 mm	20	0318560000
TW AKZ2.5 BL	0.5 mm	20	0318580000
Small partition			
EW 15	10 mm	50	0382860000
Testing / Checking			
PS 2.3 RT	5.4 mm	20	0180400000
STB 8.5/D4/2.3/M2.5 AKZ		50	0215700000

Marking systems	
	DEK 5/5
For detailed information on other accessories and applications, refer to the „Accessories“ section	

AKZ 4

4 mm²



6.1 x 27 x 30.5
41 / 6
0.13...6

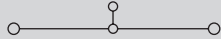

IEC 60947-7-1 Ex e II II 2 G D

IEC	UL	CSA	EN 60079-7
400	300	300	275
32	27	10	21
4	AWG 22...12	AWG 24...12	4
6 / 3			
A3 / V2			

SIRA 02ATEX3001 U

Rated connection
0.5...6 / 1.5...4
0.5...4 / 0.5...2.5
0.6...0.8 Nm (M 3)
8 / 0.6 x 3.5 mm
0.5...1.5
0.5...1.5 / 0.5...1.5

Type	Qty.	Order No.
AKZ 4	100	0294360000
AKZ 4 BL	100	0294380000

AKZ 4 order no. 0294360000 and 0294380000 made of PA with flammability class acc. to UL 94/V-2

Type	current	Qty.	Order No.
Q 2 AKZ4	32 A	50	0336400000
Q 3 AKZ4	32 A	50	0336500000
Q 4 AKZ4	32 A	50	0336600000
Q 10 AKZ4	32 A	20	0368600000
Width			
AP AKZ4	1.5 mm	20	0294460000
AP AKZ4 BL	1.5 mm	20	0294480000
TW AKZ4	0.5 mm	50	0348260000
TW AKZ4 BL	0.5 mm	50	0348280000
TSCH 4 AKZ4	6 mm	100	0363360000
EW 15	10 mm	50	0382860000
PS 2.3 RT	5.4 mm	20	0180400000
STB 8.5/D4/2.3/M2.5 AKZ		50	0215700000

DEK 5/6

SAKR 15

4 mm²



6.5 x 42 x 31
/ 4
0.13...4

IEC 60947-7-1

IEC	UL	CSA
400	300	300
10	10	10
4	AWG 22...12	AWG 26...12
6 / 3		
A3 / V2		

Rated connection
0.5...4 / 1.5...4
0.5...4 / 0.5...2.5
0.5...1.0 Nm (M 3)
8 / 0.6 x 3.5 mm

Tightening torque via the sockets is 0.5 - 0.7 Nm.

Type	Qty.	Order No.
SAKR 15	100	0412760000
SAKR 15 2STB	100	0412860000

The ZH 0.5 - ZH 1.5 twin ferrules can be used.

Type	Qty.	Order No.
Width		
AP SAKR BE	1.5 mm	20 0211360000
EW 15	10 mm	50 0382860000
PS 2.3 RT	5.4 mm	20 0180400000

DEK 5/6.5

QB 25 blank, refer to „Accessories“ section. Note that max. conductor connection with QB = 2.5 mm².

Mini modular terminals

**Modular PE terminals
TS 15 / PA**

In hazardous area applications, the installation instructions and the rated data specifications for accessories given in the technical appendix must be followed.

Width/Length/height with TS35x7.5	mm
max. current / max. cond. cross-section	A/mm ²
Max. clamping range	mm ²

Technical data

Rated data	
Rated cross-section	mm ²
Rated voltage to adjacent terminal	V
Rated impulse withstand voltage to adjacent terminal	kV
Short-time withstand current	
Pollution severity	
Gauge to IEC 60947-1 / UL94 Flammability class	
Approvals	
Clamped conductors (H05V/H07V)	
solid / stranded	mm ²
flexible / Stranded wire with end ferrules	mm ²
Tightening torque range (clamping screw)	
Tightening torque range (fixing screw)	
Stripping length / Blade size	mm/-

Note

Ordering data

Version	Note
green/yellow (PA)	

Marking systems (see assortment in catalogue 7)
Marking tags
For detailed information on other accessories and applications, refer to the „Accessories“ section

AKE 2.5

2.5 mm²

PE terminal



5.1 x 28 x 28	
/ 4	
0.13...4	

IEC 60947-7-2 Ex e II II 2 G D

IEC	UL	CSA	EN 60079-7
2.5	AWG 22...12	AWG 26...12	AWG 26...12
250			
4			
300 A (2.5 mm ²)			
	3		
	A3 / V2		

Rated connection	
0.5...4 / 1.5...2.5	
0.5...2.5 / 0.5...2.5	
0.4...0.6 Nm (M 2.5)	
0.4...0.6 Nm	
7 / 3.0 x 0.5 mm	

Type	Qty.	Order No.
AKE 2.5	100	1303360000

DEK 5/5

AKE 4 MS

4 mm²

PE terminal



7 x 32 x 30	
/ 4	
0.5...4	

IEC 60947-7-2

IEC	UL	CSA
4		
480 A (4 mm ²)		
	3	
	A3 / V2	

Rated connection	
0.5...4 / 1.5...4	
0.5...4 / 0.5...4	
0.8...1.6 Nm (M 3.5)	
0.8...1.6 Nm	
9 / 0.6 x 3.5 mm	

Type	Qty.	Order No.
AKE 4 MS	50	0211200000

AKE 4

4 mm²

PE terminal



7 x 32 x 34.5

/ 4

0.13...4

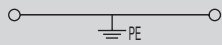

IEC 60947-7-2

Ex e II



II 2 G D

IEC	UL	CSA	EN 60079-7
4	AWG 22...12	AWG 26...12	AWG 26...12
500			
6			
480 A (4 mm ²)			
	3		
	A3 / V2		

4

AWG 22...12

AWG 26...12

AWG 26...12

500

6

480 A (4 mm²)

3

A3 / V2



SIRA 02ATEX3001 U

Rated connection

0.5...4 / 1.5...4

0.5...4 / 0.5...2.5

0.5...1.0 Nm (M3)

0.5...1.0 Nm

9 / 0.6 x 3.5 mm

Type	Qty.	Order No.
AKE 4	100	0380260000

DEK 5/6,5

Mini modular terminals

Fuse terminals
TS 15 / PA

ASK 1/15

4 mm²

In hazardous area applications, the installation instructions and the rated data specifications for accessories given in the technical appendix must be followed.

Width/Length/height with TS35x7.5	mm
max. current / max. cond. cross-section	A/mm ²
Max. clamping range	mm ²

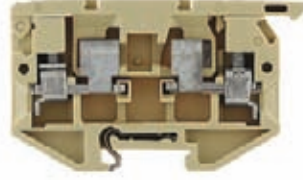

8 x 58 x 34

6.3 / 4

0.13...4



Technical data

Rated data	
Rated voltage	V
Rated current	A
Rated cross-section	mm ²
Rated impulse voltage / Pollution severity	kV/-
Gauge to IEC 60947-1 / UL94 Flammability class	
Approvals	

Clamped conductors (H05V/H07V)

solid / stranded	mm ²
flexible / Stranded wire with end ferrules	mm ²
Tightening torque range (clamping screw)	
Stripping length / Blade size	mm/-

2 conductors with same cross-section (H05V/H07V)

solid / stranded	-
flexible / Stranded wire with end ferrules	-

Note

IEC	UL	CSA
500	300	300
6.3	10	6.3
4	AWG 22...12	AWG 26...12
	6 / 3	
	A3 / V2	



Rated connection

0.5...4 / 1.5...4
0.5...4 / 0.5...4
0.5...1.0 Nm (M 3)
9 / 0.6 x 3.5 mm

Note: max. conductor size = 2.5 mm² when using the cross-connection. Twin wire-end ferrules ZH 0.5 - ZH 1.5 can be used.

Ordering data

Version	Without LED
---------	-------------

Note

Type	Qty.	Order No.
ASK 1/15	100	0376860000

Accessories

Screwable cross-connection	
2-pole	
3-pole	
4-pole	

Type	current	Qty.	Order No.
QB 2 WI RA8 IS	27 A	50	0461100000
QB 3 WI RA8 IS	27 A	50	0461200000
QB 4 WI RA8 IS	27 A	50	0461300000

Marking systems (see assortment in catalogue 7)

Marking tags

For detailed information on other accessories and applications, refer to the „Accessories“ section

DEK 5/6,5

Contact Sleeve order no. 0553300000;
AP ASK 1 order no. 0380360000.

Mini modular terminals

**with push-on connection
TS 15 / PA**

In hazardous area applications, the installation instructions and the rated data specifications for accessories given in the technical appendix must be followed.

Width/Length/height with TS35x7.5	mm
max. current / max. cond. cross-section	A/mm ²
Max. clamping range	mm ²

Technical data

Rated data	
Rated voltage	V
Rated current	A
Rated cross-section	mm ²
Rated impulse voltage / Pollution severity	kV/-
Gauge to IEC 60947-1 / UL94 Flammability class	
Approvals	

Clamped conductors (H05V/H07V)	
solid / stranded	mm ²
flexible / Stranded wire with end ferrules	mm ²
Tightening torque range (clamping screw)	
Stripping length / Blade size	mm/-
2 conductors with same cross-section (H05V/H07V)	
solid / stranded	-
flexible / Stranded wire with end ferrules	-

Note

Ordering data

Version	
	Slotted
	Not slit

Note

Accessories

Screwable cross-connection	
	2-pole
	3-pole
	4-pole
	10-pole

End plate / Partition plate	
	Dark beige Wemid
	Dark beige Wemid

Testing / Checking	
	Test plug
	Socket

Insulating sleeve	
	2,8
	6,3

Marking systems	(see assortment in catalogue 7)
	Marking tags

For detailed information on other accessories and applications, refer to the „Accessories“ section

AKZ 4 SS SE 6.3/2.8

2.5 mm²



6 x 28.45 x 30.5	
16 /	

IEC 60947-7-1 / IEC 61210

IEC	UL	CSA
400	150	300
8	10	10
2.5	AWG 22...12	AWG 24...12
6 / 3		
/ V2		

Rated connection

...4

Rated voltage is 400 V when insulation sleeves are used I max 20 A valid when used with 2 x F 6.3 or 4 x F 2.8.

Type	Qty.	Order No.
AKZ 4 SS SE 6.3/2.8	100	0324560000

Type	current	Qty.	Order No.
Q 2 AKZ4SS	20 A	50	0369000000
Q 3 AKZ4SS	20 A	50	0369100000
Q 4 AKZ4SS	20 A	50	0369200000
Q 10 AKZ4SS	20 A	20	0369300000

Width	
AP AKZ4	1.5 mm 20 0294460000
TW AKZ4	0.5 mm 50 0348260000

PS 2.3 RT	5.4 mm 20 0180400000
STB 8.5/D4/2.3/M2.5 AKZ	50 0215700000

IH 2.8 DB	100 0386060000
IH 6.3 WEM GE	100 0386260000

DEK 5/6

AKZ 4 SS WA 2*2.8

1 mm²

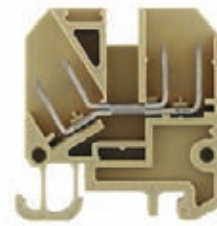

6 x 28.45 x 30.5	
8 / 1	
0.2...1	

IEC 60947-7-1 / IEC 61210

IEC	UL	CSA
400	150	300
8	10	10
1	AWG 22...12	AWG 24...12
6 / 3		
/ V2		

Rated connection

Type	Qty.	Order No.
AKZ 4 SS WA 2X2.8	100	0362460000

Type	current	Qty.	Order No.
Q 2 AKZ4SS	20 A	50	0369000000
Q 3 AKZ4SS	20 A	50	0369100000
Q 4 AKZ4SS	20 A	50	0369200000
Q 10 AKZ4SS	20 A	20	0369300000

Width	
AP AKZ4	1.5 mm 20 0294460000
TW AKZ4	0.5 mm 50 0348260000

PS 2.3 RT	5.4 mm 20 0180400000
STB 8.5/D4/2.3/M2.5 AKZ	50 0215700000

IH 2.8 DB	100 0386060000
-----------	-----------------------

DEK 5/6

AKZ 4 S WA 2*2.8

4 mm²



6 x 27 x 30

8 /

...

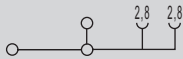

IEC 60947-7-1 / IEC 61210

IEC	UL	CSA
400	150	300
8	20	10
4	AWG 22...12	AWG 24...12
	6 / 3	
	A3 / V2	



Rated connection

0.5...4 / 1.5...4

0.5...4 / 0.5...1

0.6...0.8 Nm (M 3)

8 / 0.6 x 3.5 mm

AKZ 4 SF SE 6.3/2.8

4 mm²



6 x 27 x 30

8 / 4

0.2...4

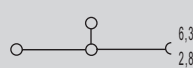

IEC 60947-7-1 / IEC 61210

IEC	UL	CSA
400		300
8		10
4		AWG 24...12
		6 / 3
	A3 / V2	



Rated connection

0.5...4 / 1.5...4

0.5...4 / 0.5...2.5

0.6...0.8 Nm (M 3)

8 / 0.6 x 3.5 mm

Type	Qty.	Order No.
AKZ 4 S WA 2X2.8	100	0324460000

Type	Qty.	Order No.
AKZ 4 SF SE 6.3/2.8	100	0158760000

Type	current	Qty.	Order No.
Q 2 AKZ4	32 A	50	0336400000
Q 3 AKZ4	32 A	50	0336500000
Q 4 AKZ4	32 A	50	0336600000
Q 10 AKZ4	32 A	20	0368600000
Width			
AP AKZ4	1.5 mm	20	0294460000
TW AKZ4	0.5 mm	50	0348260000
Width			
PS 2.3 RT	5.4 mm	20	0180400000
STB 8.5/D4/2.3/M2.5 AKZ		50	0215700000
Width			
IH 2.8 DB		100	0386060000

Type	current	Qty.	Order No.
Q 2 AKZ4	32 A	50	0336400000
Q 3 AKZ4	32 A	50	0336500000
Q 4 AKZ4	32 A	50	0336600000
Q 10 AKZ4	32 A	20	0368600000
Width			
AP AKZ4	1.5 mm	20	0294460000
TW AKZ4	0.5 mm	50	0348260000
Width			
PS 2.3 RT	5.4 mm	20	0180400000
STB 8.5/D4/2.3/M2.5 AKZ		50	0215700000
Width			
IH 2.8 DB		100	0386060000
IH 6.3 WEM GE		100	0386260000

DEK 5/6

DEK 5/6

Mini modular terminals

**with solder connection
TS 15 / PA**

In hazardous area applications, the installation instructions and the rated data specifications for accessories given in the technical appendix must be followed.

Width/Length/height with TS35x7.5	mm
max. current / max. cond. cross-section	A/mm ²
Max. clamping range	mm ²

Technical data

Rated data	
Rated voltage	V
Rated current	A
Rated cross-section	mm ²
Rated impulse voltage / Pollution severity	kV/-
Gauge to IEC 60947-1 / UL94 Flammability class	
Approvals	
Clamped conductors (H05V/H07V)	
solid / stranded	mm ²
flexible / Stranded wire with end ferrules	mm ²
Tightening torque range (clamping screw)	
Stripping length / Blade size	mm/-

Note

Ordering data

Version	
	beige
Note	

Accessories

Screwable cross-connection	
	2-pole
	3-pole
	4-pole
	10-pole
Switchable link	
	Switchable link
	Connecting sleeve
	Mounting screw
Testing / Checking	
	Test plug
	Socket
End plate / Partition plate	
	Dark beige Wemid
	Dark beige Wemid
Small partition	
	Small partition
Cover / warning label	
	Cover / warning label
	Mounting screw (plastic)

Marking systems (see assortment in catalogue 7)
Marking tags

For detailed information on other accessories and applications, refer to the „Accessories“ section

AKZ 1.5L VS

1.5 mm²



5 x 34.4 x 25.5	
16 / 2.5	
0.2...2.5	

IEC 60947-7-1 / IEC 60068-2-20

IEC	UL	CSA
250		150
16		10
1.5		AWG 24...16
		4 / 3
		A1 / V2

Rated connection			
0.5...2.5 / 0.5...1.5			
0.5...1.5 / 0.5...1.5			
0.4...0.6 Nm (M 2.5)			
7 / 3.0 x 0.5 mm			

Type	Qty.	Order No.
AKZ 1.5L VS	100	0340160000

Type	current	Qty.	Order No.
Q 2 AKZ1.5	24 A	50	0368200000
Q 3 AKZ1.5	24 A	50	0368300000
Q 4 AKZ1.5	24 A	50	0368400000
Q 10 AKZ1.5	24 A	20	0368500000
Width			
PS 2.3 RT	5.4 mm	20	0180400000
STB 8.5/D4/2.3/M2.5 AKZ		50	0215700000
Width			
AP AKZ1.5W	1.5 mm	20	0329660000
TW AKZ4 HP/DBR/0.5	0.5 mm	50	0166800000

DEK 5/5

AKZ 4 L

4 mm²

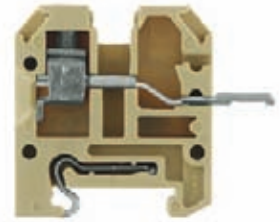

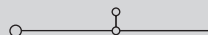
6 x 35.6 x 30	
17.5 / 4	
0.2...4	

IEC 60947-7-1 / IEC 60068-2-20

IEC	UL	CSA
250	300	300
17.5	20	10
4	AWG 22...12	AWG 24...12
		4 / 3
		A3 / V2

Rated connection			
0.5...4 / 1.5...4			
0.5...4 / 0.5...2.5			
0.6...0.8 Nm (M 3)			
8 / 0.6 x 3.5 mm			

Type	Qty.	Order No.
AKZ 4L SL VS	100	0334860000

Type	current	Qty.	Order No.
Q 2 AKZ4	32 A	50	0336400000
Q 3 AKZ4	32 A	50	0336500000
Q 4 AKZ4	32 A	50	0336600000
Q 10 AKZ4	32 A	20	0368600000
VL 2 AKZ4/DK4		50	0446700000
VH 10/4/2.8 AKZ4		50	0446600000
BFSC M2.5X14 SAKD2.5N		100	0266800000
Width			
PS 2.3 RT	5.4 mm	20	0180400000
STB 8.5/D4/2.3/M2.5 AKZ		50	0215700000
Width			
AP AKZ4	1.5 mm	20	0294460000
TW AKZ4	0.5 mm	50	0348260000
TSCH 4 AKZ4	6 mm	100	0363360000
AD 4 AKZ4		50	0303400000
BFSC M2.5X18 PA/RT		100	0303300000

DEK 5/6

AKZ 4 LL VS

1.5 mm²



6 x 45.5 x 30
17.5 / 1.5
0.2...1.5

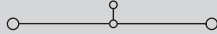

IEC 60947-7-1 / IEC 60068-2-20

IEC	UL	CSA
250	300	300
17.5	20	10
1.5	AWG 22...12	AWG 24...12
	4 / 3	
	/ V2	



Rated connection

0.5...1.5 / 0.5...1.5
 0.5...1.5 / 0.5...1.5

ADK 1

4 mm²



6 x 22 x 36.5
16 / 4
0.13...4

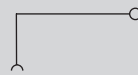

IEC	UL	CSA
400	300	300
16	10	15
4	AWG 26...12	AWG 26...12
	6 / 3	
	A3 / V2	



Rated connection

0.5...4 / 1.5...2.5
 0.5...4 / 0.5...2.5
 0.5...0.8 Nm (M 3)
 9 / 0.6 x 3.5 mm

Type	Qty.	Order No.
AKZ 4 LL VS	100	0346460000

Type	Qty.	Order No.
ADK 1/1.5	100	0303860000

Type	current	Qty.	Order No.
Q 2 AKZ4	32 A	50	0336400000
Q 3 AKZ4	32 A	50	0336500000
Q 4 AKZ4	32 A	50	0336600000
Q 10 AKZ4	32 A	20	0368600000
VL 2 AKZ4/DK4	32 A	50	0446700000
VH 10/4/2.8 AKZ4		50	0446600000
BFSC M2.5X14 SAKD2.5N		100	0266800000
Width			
PS 2.3 RT	5.4 mm	20	0180400000
STB 8.5/D4/2.3/M2.5 AKZ		50	0215700000
AP AKZ4	1.5 mm	20	0294460000
TW AKZ4	0.5 mm	50	0348260000
TSCH 4 AKZ4	6 mm	100	0363360000
AD 4 AKZ4		50	0303400000
BFSC M2.5X18 PA/RT		100	0303300000

Type	Qty.	Order No.	
PS 2.3 RT	5.4 mm	20	0180400000
Width			
AP ADK1	50	0476260000	
TW ADK1 HP/DBR/0.5	0.5 mm	50	0442300000

DEK 5/6

DEK 5/6

Mini modular terminals

**with solder connection
TS 15 / KrG**

In hazardous area applications, the installation instructions and the rated data specifications for accessories given in the technical appendix must be followed.

Width/Length/height with TS35x7.5	mm
max. current / max. cond. cross-section	A/mm ²
Max. clamping range	mm ²

Technical data

Rated data	
Rated voltage	V
Rated current	A
Rated cross-section	mm ²
Rated impulse voltage / Pollution severity	kV/-
Gauge to IEC 60947-1 / UL94 Flammability class	Approvals
Clamped conductors (H05V/H07V)	
solid / stranded	mm ²
flexible / Stranded wire with end ferrules	mm ²
Tightening torque range (clamping screw)	
Stripping length / Blade size	mm/-
Note	

Ordering data

Version	
	Medium yellow
	Blue
Note	

Accessories

Screwable cross-connection	
	2-pole
	3-pole
	4-pole
	10-pole
Switchable link	
	Switchable link
	Connecting sleeve
	Mounting screw
Testing / Checking	
	Test plug
	Socket
End plate / Partition plate	
	Medium yellow
	Blue
	Dark beige Wemid
	Dark beige Wemid
Small partition	
	Small partition
Cover / warning label	
	Cover / warning label
	Mounting screw (plastic)
Marking systems	
	(see assortment in catalogue 7)
	Marking tags
For detailed information on other accessories and applications, refer to the „Accessories“ section	

AKZ 4 L KRG

4 mm²

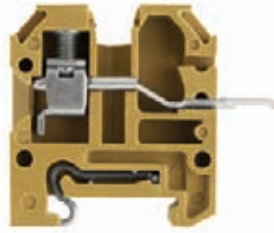

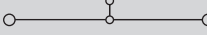
6 x 35.5 x 30	
16 / 4	
0.2...4	

IEC 60947-7-1 / IEC 60068-2-20		
IEC	UL	CSA
250	300	300
16	20	10
4	AWG 22...12	AWG 24...12
4 / 3		
A3 / 5VA		
Rated connection		
0.5...4 / 1.5...4		
0.5...4 / 0.5...2.5		
0.6...0.8 Nm (M 3)		
8 / 0.6 x 3.5 mm		

Type	Qty.	Order No.
AKZ 4L SL VS KRG	100	0334820000

Type	current	Qty.	Order No.
Q 2 AKZ4	32 A	50	0336400000
Q 3 AKZ4	32 A	50	0336500000
Q 4 AKZ4	32 A	50	0336600000
Q 10 AKZ4	32 A	20	0368600000
Width			
VL 2 AKZ4/DK4		50	0446700000
VH 10/4/2.8 AKZ4		50	0446600000
BFSC M2.5X14 SAKD2.5N		100	0266800000
Width			
PS 2.3 RT	5.4 mm	20	0180400000
STB 8.5/D4/2.3/M2.5 AKZ		50	0215700000
AP AKZ4	1.5 mm	20	0294460000
TW AKZ4	0.5 mm	50	0348260000
Width			
TSCH 4 AKZ4	6 mm	100	0363360000
AD 4 AKZ4		50	0303400000
BFSC M2.5X18 PA/RT		100	0303300000
Width			
DEK 5/6			

AKA 2.5

2.5 mm²

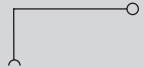

6 x 20 x 31	
20 / 2.5	
0.13...2.5	

IEC 60947-7-1 / IEC 60068-2-20		
IEC	UL	CSA
400	300	300
20	20	10
2.5	AWG 20...12	AWG 24...12
6 / 3		
A3 / V-0		
Rated connection		
0.5...2.5 / 1.5...2.5		
0.5...2.5 / 0.5...1.5		
0.4...0.45 Nm (M 2.5)		
9 / 0.6 x 3.5 mm		

Type	Qty.	Order No.
AKA 2.5	100	0300720000
AKA 2.5 BL	100	0300770000

Type	Qty.	Order No.
AP AKA2.5	100	0162520000
AP AKA2.5 KRG/BL	50	0162570000
Width		
DEK 5/6		

with Termi-Point / Wire-Wrap connection
TS 15 / PA

AKZ 4 T

4 mm²

AKZ 2.5K

2.5 mm²

In hazardous area applications, the installation instructions and the rated data specifications for accessories given in the technical appendix must be followed.

Width/Length/height with TS35x7.5	mm
max. current / max. cond. cross-section	A/mm ²
Max. clamping range	mm ²



6 x 27 x	
10 / 4	
0.2...4	



5 x 29 x 46	
8 / 5.26	
0.13...5.26	

Technical data

Rated data	
Rated voltage	V
Rated current	A
Rated cross-section	mm ²
Rated impulse voltage / Pollution severity	kV/-
Gauge to IEC 60947-1 / UL94 Flammability class	
Approvals	
Clamped conductors (H05V/H07V)	
solid / stranded	mm ²
flexible / Stranded wire with end ferrules	mm ²
Tightening torque range (clamping screw)	
Stripping length / Blade size	mm/-
Note	

IEC 60947-7-1

IEC	UL	CSA
250	300	300
10	10	10
4	AWG 26...14	AWG 24...12
4 / 3		
A3 / V2		

Rated connection	
0.5...4 / 1.5...4	
0.5...4 / 0.5...2.5	
0.6...0.8 Nm (M 3)	
8 / 0.6 x 3.5 mm	

IEC	UL	CSA
250	300	300
8	10	10
2.5	AWG 22...12	AWG 26...10
4 / 3		
A2 / V2		

Rated connection	
0.5...2.5 / 1.5...2.5	
0.5...2.5 / 0.5...2.5	
0.4...0.6 Nm (M 2.5)	
7 / 3.0 x 0.5 mm	

Ordering data

Version
right
Vertical right
Note

Type	Qty.	Order No.
AKZ 4 SW 1X1	100	0445860000
Note		

Type	Qty.	Order No.
AKZ 2.5 K SW U/V 1X1	100	0108960000
Note		

Accessories

Screwable cross-connection	
	2-pole
	3-pole
	4-pole
	10-pole
End plate / Partition plate	
	Dark beige Wemid
	Dark beige Wemid
Small partition	
	Small partition
Testing / Checking	
	Test plug
	Socket

Type	current	Qty.	Order No.
Q 2 AKZ4	32 A	50	0336400000
Q 3 AKZ4	32 A	50	0336500000
Q 4 AKZ4	32 A	50	0336600000
Q 10 AKZ4	32 A	20	0368600000
Width			
AP AKZ4	1.5 mm	20	0294460000
TW AKZ4	0.5 mm	50	0348260000
TSCH 4 AKZ4	6 mm	100	0363360000
PS 2.3 RT	5.4 mm	20	0180400000
STB 8.5/D4/2.3/M2.5 AKZ		50	0215700000

Type	Qty.	Order No.
Width		
AP AKZ2.5K	3 mm	50
TW AKZ2.5	0.5 mm	20
PS 2.3 RT	5.4 mm	20
STB 8.5/D4/2.3/M2.5 AKZ		50

Marking systems	(see assortment in catalogue 7)
	Marking tags
For detailed information on other accessories and applications, refer to the „Accessories“ section	

DEK 5/6

DEK 5/5

Multi-pole terminal strips

Multi-pole terminal strips for direct mounting	Screw connection	F.2
	Screw connection ATEX approval	F.6

Multi-pole terminal strips for direct mounting

Screw connection

MK 2/12

2.5 mm²

MK 3/2...12

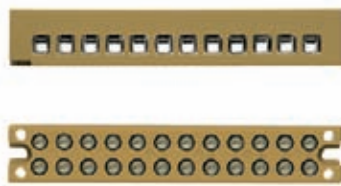
2.5 mm²

Width/Height/ø mounting hole	mm
Length / mounting dimensions	
Max. clamping range	mm ²

15 x 15 / 3.2
Refer to order data
0.2...4

15 x 16.1 / 3.45
Refer to order data
0.33...4

Technical data

Rated data	
Rated voltage	V
Rated current	A
Rated cross-section	mm ²
Rated impulse voltage / Pollution severity	kV/-
Gauge to IEC 60947-1 / UL94 Flammability class	
Approvals	
Clamped conductors (H05V/H07V)	
Solid / Stranded	mm ²
Flexible / Stranded wire with end ferrules	mm ²
Tightening torque range (clamping screw)	
Stripping length / Blade size	mm/-

IEC 60947-7-1

IEC	UL	CSA
125	300	300
24	10	10
2.5	AWG 24...12	AWG 24...12
3 / 3		
A2 / 5VA		



Rated connection

0.5...4 / 1.5...2.5
0.5...2.5 / 0.5...1.5
0.4 Nm (M 2.5)
5 / 0.6 x 3.5 mm

IEC 60947-7-1

IEC	UL	CSA
400	300	300
24	25	25
2.5	AWG 22...12	AWG 22...12
6 / 3		
A2 / 5VA		



Rated connection

0.5...4 / 1.5...2.5
0.5...2.5 / 0.5...1.5
0.4...0.45 Nm (M 2.5)
5 / 0.6 x 3.5 mm

Note

Ordering data

Version	
2-pole	
3-pole	
4-pole	
5-pole	
6-pole	
7-pole	
8-pole	
9-pole	
10-pole	
12-pole	MK 2/12
14-pole	
16-pole	

Note

Type	Length	Mounting dimensions	Qty.	Order No.
MK 2/12	86 mm	80.0 mm	50	0241260000

Type	Length	Mounting dimensions	Qty.	Order No.
MK 3/2	17.4 mm	18.5 mm	100	0273820000
MK 3/3	26.5 mm	18.5 mm	50	0273920000
MK 3/4	35.75 mm	18.5 mm	50	0274020000
MK 3/5	45 mm	18.5 mm	50	0274120000
MK 3/6	54.25 mm	37.0 mm	50	0274220000
MK 3/7	63.5 mm	37.0 mm	50	0274320000
MK 3/8	72.75 mm	55.5 mm	25	0274420000
MK 3/9	82 mm	55.5 mm	25	0274520000
MK 3/10	91.25 mm	74.0 mm	20	0274620000
MK 3/12	110 mm	92.5 mm	20	0243520000

Accessories

Solder strip	
Marking strips, printed	
Printed	
Marking strips, unprinted	
Unprinted	

Type	Width	Qty.	Order No.
MF 2/12 1X2.8/1.6	75 mm	100	0241760000
BSTB 28/12/6.35 U 1-12		50	0245700000
BSTB 28/12/6.35 O 1-12		50	0278500000
BSTO 28/12/6.35		50	0245600000

Type	Qty.	Order No.
BSTB 28/12 MK U 1-12	50	0245900000
BSTB 28/8 MK U 1-8	50	0290200000
BSTB 28/6 MK U 1-6	50	0290000000
BSTO 28/12 MK	50	0245800000
BSTO 28/8 MK3/8	50	0284700000
BSTO 28/6 MK	50	0289500000
BSTO 28/4 MK3/4	50	0289300000

(see assortment in catalogue 7)

For detailed information on other accessories and applications, refer to the „Accessories“ section.

MK 4/16

2.5 mm²

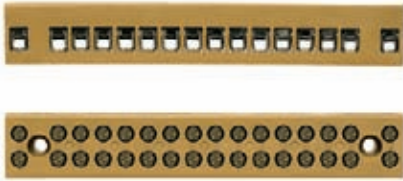

17 x 16 / 3.4

Refer to order data

0.2...4

IEC 60947-7-1

IEC	UL	CSA
400	150	150
24	20	15
2.5	AWG 22...12	AWG 22...12
6 / 3		
A2 / 5VA		



Rated connection

0.5...4 / 1.5...2.5
 0.5...2.5 / 0.5...1.5
 0.4...0.45 Nm (M 2.5)
 5 / 0.6 x 3.5 mm

MK 6/2...6/6

6 mm²

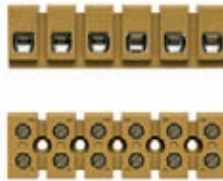

23 x 22 / 3.4

Refer to order data

0.33...6

IEC 60947-7-1

IEC	UL	CSA
690	300	300
41	30	40
6	AWG 22...10	AWG 22...10
8 / 3		
A3 / 5VA		



Rated connection

0.5...6 / 1.5...6
 0.5...6 / 0.5...4
 1.2...2.0 Nm (M 4)
 9 / 4.0 x 0.8 mm

MK 10/14

2.5 mm²



13.5 x 12 / 3.1

Refer to order data

0.21...4

IEC 60947-7-1

IEC	UL	CSA
125	150	300
24	25	10
2.5	AWG 22...12	AWG 24...12
3 / 3		
A2 / V2		



Rated connection

0.5...4 / 1.5...2.5
 0.5...2.5 / 0.5...1.5
 0.4...0.45 Nm (M 2.5)
 6 / 0.6 x 3.5 mm

Type	Length	Mounting dimensions	Qty.	Order No.
MK 4/16	103 mm	85.5 mm	20	0244220000

Type	Length	Mounting dimensions	Qty.	Order No.
MK 6/2	23.5 mm		50	0620420000
MK 6/3	36.5 mm	13.0 mm	50	0620320000
MK 6/4	49.5 mm	26.0 mm	20	0620220000
MK 6/6	75.5 mm	52.0 mm	20	0620120000

Type	Length	Mounting dimensions	Qty.	Order No.
MK 10/14	88.5 mm		20	0370160000

Type	Breite	Qty.	Order No.
BSTB 28/16 MK U 1-16		50	0262200000
BSTB 28/16 MK O 1-16		50	0278700000
BSTO 28/16 MK 4/16		50	0262100000

Type	Breite	Qty.	Order No.
------	--------	------	-----------

Type	Breite	Qty.	Order No.
------	--------	------	-----------

Multi-pole terminal strips for direct mounting

Screw connection

MK 5/2 0.DE

2.5 mm²

KS 2...10

2.5 mm²



Width/Height/ø mounting hole	mm
Length / mounting dimensions	
Max. clamping range	mm ²

18 x 14 / 4.2
Refer to order data
0.2...4

25 x 17.5 / 4.2
Refer to order data
0.2...4

Technical data

Rated data	
Rated voltage	V
Rated current	A
Rated cross-section	mm ²
Rated impulse voltage / Pollution severity	kV/-
Gauge to IEC 60947-1 / UL94 Flammability class	
Approvals	
Clamped conductors (H05V/H07V)	
Solid / Stranded	mm ²
Flexible / Stranded wire with end ferrules	mm ²
Tightening torque range (clamping screw)	
Stripping length / Blade size	mm/-

IEC	UL	CSA
500		
24		
2.5		
	6 / 3	
	A2 / 5VA	
Rated connection		
0.5...4 / 1.5...2.5		
0.5...2.5 / 0.5...1.5		
0.4 Nm (M 2.5)		
5 / 0.6 x 3.5 mm		

IEC 60947-7-1

IEC	UL	CSA
500	300	300
24	20	25
2.5	AWG 22...12	AWG 24...12
	6 / 3	
	A2 / 5VA	
Rated connection		
0.5...4 / 1.5...2.5		
0.5...2.5 / 0.5...1.5		
0.5...0.7 Nm (M 3)		
8 / 4.0 x 0.8 mm		

Note

Ordering data

Version
2-pole
3-pole
4-pole
6-pole
10-pole
12-pole

Type	Length	Mounting dimensions	Qty.	Order No.
MK 5/2 0.DE	40 mm	32.0 mm	100	0243820000

Type	Length	Mounting dimensions	Qty.	Order No.
KS 2 0.D2	42 mm	32.0 mm	100	0134420000
KS 4 0.D4	66 mm	56.0 mm	50	0140320000
KS 6 0.D6	90 mm	80.0 mm	50	0140620000
KS 10 0.D10	138 mm	128.0 mm	20	0141620000

Note

Accessories

Lid / cover

Marking strips, printed
Printed

Marking strips, unprinted
Unprinted

Type	Width	Qty.	Order No.
D 2 MK5/2 PA/NA	18 mm	50	0244060000

Type	Width	Qty.	Order No.
D2 KS2 TP	25 mm	100	0134500000
D4 KS4 TP	48 mm	50	0140500000
D6 KS6 TP	72 mm	50	0140800000
D10 KS10 TP	120 mm	20	0141800000
ELSB 2 BEZ. 1-2		50	0143200000
ELSB 4 BEZ. 1-4		50	0143300000
ELSB 6 BEZ. 1-6		50	0143400000
ELSB 10 BEZ. 1-10		50	0143500000
ELSO 2 F.KS 2		50	0142800000
ELSO 4 F.KS 4		50	0142900000
ELSO 6 F.KS 6		50	0143000000
ELSO 10 F.KS 10		50	0143100000

(see assortment in catalogue 7)

For detailed information on other accessories and applications, refer to the „Accessories“ section.

BK 2...12

4 mm²



22 x 20 / 3.4

Refer to order data

0.33...4

IEC 60947-7-1

IEC	UL	CSA
400	300	300
32	10	10
4	AWG 22...12	AWG 22...12
	6 / 3	
	A3 / 5VA	

UL

Rated connection

0.5...4 / 1.5...4

0.5...4 / 0.5...4

0.5...0.6 Nm (M 3)

8 / 4.0 x 0.8 mm

2 single-wire conductors with same cross-section (0.5...1.5 mm²) can be connected.

Type	Length	Mounting dimensions	Qty.	Order No.
BK 2 CRN	20 mm		100	0624720000
BK 3 CRN	31 mm	11.0 mm	100	0624920000
BK 4 CRN	38 mm	18.0 mm	100	0625120000
BK 6 CRN	52 mm	32.0 mm	50	0625220000
BK 12 CRN	92 mm	72.5 mm	25	0625320000

Type	Width	Qty.	Order No.
BSTB 28/2 BK U 1-2		50	0203600000
HASUE SAKR15LS		n.a.	2038000000
BSTB 28/4 BK U 1-4		50	0197300000
BSTB 28/6 BK U 1-6		50	0197500000
BSTB 28/12 BK U 1-12		50	0198800000
BSTO 28/2 BK		50	0203500000
BSTO 28/3 BK		50	0203700000
BSTO 28/4 BK		50	0197200000
BSTO 28/6 BK		50	0197400000
BSTO 28/12 BK		50	0198700000

Multi-pole terminal strips for direct mounting

Screw connection
ATEX approval

BK 2...12/E

4 mm²

MK 3/2...12/E

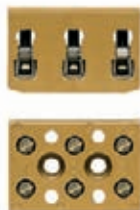
2.5 mm²

Width/Height/ø mounting hole	mm
Length / mounting dimensions	
Max. clamping range	mm ²

22 x 20 / 3.4
Refer to order data
0.33...4

15 x 16.1 / 3.45
Refer to order data
0.33...4

Technical data

Rated data	
Rated voltage	V
Rated current	A
Rated cross-section	mm ²
Rated impulse voltage / Pollution severity	kV/-
Gauge to IEC 60947-1 / UL94 Flammability class	
Approvals	
Clamped conductors (H05V/H07V)	
Solid / Stranded	mm ²
Flexible / Stranded wire with end ferrules	mm ²
Tightening torque range (clamping screw)	
Stripping length / Blade size	mm/-

IEC 60947-7-1

IEC	UL	CSA
400		
32		
4	AWG 22...12	AWG 22...12
	6 / 3	
	A3 / 5VA	

IEC 60947-7-1

IEC	UL	CSA
400		
24		
2.5	AWG 22...12	AWG 22...12
	6 / 3	
	A2 / 5VA	



Rated connection

0.5...4 / 1.5...4
0.5...4 / 0.5...4
0.5...0.6 Nm (M 3)
8 / 4.0 x 0.8 mm



Rated connection

0.5...4 / 1.5...2.5
0.5...2.5 / 0.5...1.5
0.4...0.45 Nm (M 2.5)
5 / 0.6 x 3.5 mm

Note

2 single-wire conductors with same cross-section (0.5...1.5 mm²) can be connected.

Ordering data

Version	
2-pole	
3-pole	
4-pole	
5-pole	
6-pole	
7-pole	
8-pole	
9-pole	
10-pole	
11-pole	
12-pole	

Type	Length	Mounting dimensions	Qty.	Order No.
BK 2/E	20 mm		100	7906040000
BK 3/E	31 mm	11.0 mm	100	7906060000
BK 4/E	38 mm	18.0 mm	100	7906080000
BK 6/E	52 mm	32.0 mm	50	7906090000
BK 12/E	92 mm	72.5 mm	25	7906100000

Type	Length	Mounting dimensions	Qty.	Order No.
MK 3/2/E	17.4 mm	18.5 mm	100	7906110000
MK 3/3/E	26.5 mm	18.5 mm	100	7906120000
MK 3/4/E	35.75 mm	18.5 mm	50	7906130000
MK 3/5/E	45 mm	18.5 mm	50	7906140000
MK 3/6/E	54.25 mm	37.0 mm	50	7906150000
MK 3/7/E	63.5 mm	37.0 mm	25	7906160000
MK 3/8/E	72.75 mm	55.5 mm	25	7906170000
MK 3/9/E	82 mm	55.5 mm	25	7906180000
MK 3/10/E	91.25 mm	74.0 mm	25	7906190000
MK 3/11/E	100.5 mm	74.0 mm	20	7906200000
MK 3/12/E	110 mm	92.5 mm	25	7906210000

Note

Accessories

Marking strips, printed	
Printed	

Type	Qty.	Order No.
BSTB 28/2 BK U 1-2	50	0203600000
HASUE SAKR15LS	n.a.	2038000000
BSTB 28/4 BK U 1-4	50	0197300000
BSTB 28/6 BK U 1-6	50	0197500000
BSTB 28/12 BK U 1-12	50	0198800000

Type	Qty.	Order No.
BSTB 28/12 MK U 1-12	50	0245900000
BSTB 28/8 MK U 1-8	50	0290200000
BSTB 28/6 MK U 1-6	50	0290000000

Marking strips, unprinted	
Unprinted	

BSTO 28/2 BK	50	0203500000
BSTO 28/3 BK	50	0203700000
BSTO 28/4 BK	50	0197200000
BSTO 28/6 BK	50	0197400000
BSTO 28/12 BK	50	0198700000

BSTO 28/12 MK	50	0245800000
BSTO 28/8 MK3/8	50	0284700000
BSTO 28/6 MK	50	0289500000
BSTO 28/4 MK3/4	50	0289300000

(see assortment in catalogue 7)

For detailed information on other accessories and applications, refer to the „Accessories“ section

MK 6/2...6/E

6 mm²



23 x 22 / 3.4

Refer to order data

0.33...6

IEC 60947-7-1

IEC	UL	CSA
690		
41		
6	AWG 22...10	AWG 22...10
	8 / 3	
	A3 / 5VA	



Rated connection

0.5...6 / 1.5...6

0.5...6 / 0.5...4

1.2...2.0 Nm (M 4)

9 / 4.0 x 0.8 mm

Type	Length	Mounting dimensions	Qty.	Order No.
MK 6/2/E	23.5 mm		50	7906220000
MK 6/3/E	36.5 mm	13.0 mm	50	7906230000
MK 6/4/E	49.5 mm	26.0 mm	20	7906240000
MK 6/5/E	62.5 mm	26.0 mm	20	7906250000
MK 6/6/E	75.5 mm	52.0 mm	20	7906260000

Type	Width	Qty.	Order No.

KLBÜ shielded connection

KLBÜ shielded connection	Overview shield connection terminals KLBÜ	G.2
	Shield connection terminals KLBÜ for 10 x 3 mm busbars	
	Clamping yoke	G.4
	Busbar holders	G.6
	Shield connection terminals KLBÜ – Mounting directly on metal plate	
	Clamping yoke	G.8
	Busbar holder / Spacer	G.9
	Shield connection terminals KLBÜ – Mounting on TS 35	
	FM 4-foot / Clamping yoke holder	G.10
	Shield connection terminals KLBÜ for the C profile	
	Clamping yoke	G.11

The theoretical concept

Part 1 of the VDE 0133 standard specifies the required equipotential bonding for the electrical components of a machine. The aim is to prevent any undesirable consequences occurring as a result of electrostatic, electromagnetic and net-work bound interference.

The following measures serve this purpose:

- Using filters and time delay devices.
- Dividing earth (PE) into “dirty” and “clean”.
- Neutral grounding using large earth cables for bonding.
- Keeping all bonding leads as short as possible.
- Routing all connections parallel to the bonding surface.
- Separation and shielding of switching devices and interference sensitive equipment, shielded at one end only.
- Shielded lines are used for all motor and all signal connection. These shielded cables for signals are grounded at one end. Drives to Motors should be grounded at both ends.
- The mass current is neutral grounded

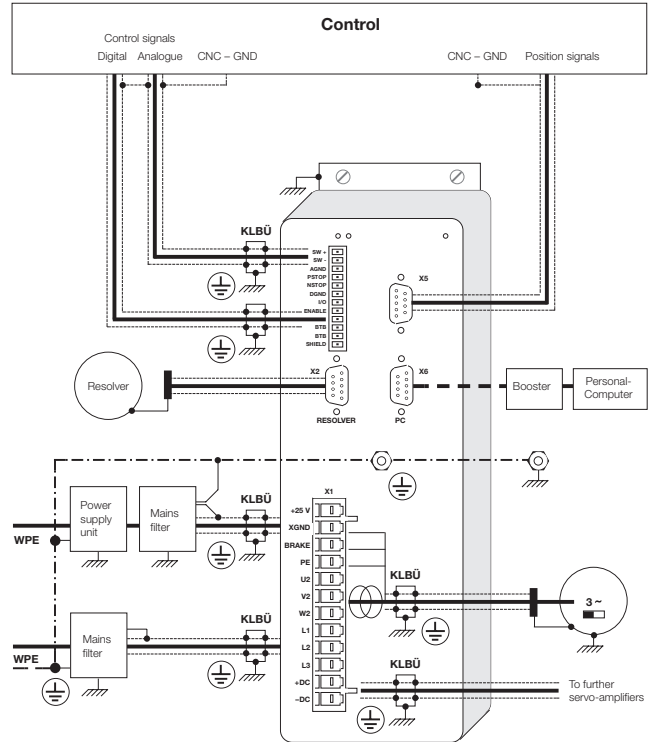

Overview of KLBÜ fittings available

For busbars
10 x 3

For direct mounting

For C-profiles

For TS 35
insulating/conducting

Clip-on for
10 x 3 busbar



In detail

Compression spring

- To ensure both simple handling and proper connection with permanent contact pressure as a result of the spring effect



No extra tools necessary

- Simply **swivel onto the busbar by hand** – retrospectively if necessary

Full range

- For conductors from 2 to 37 mm diameter

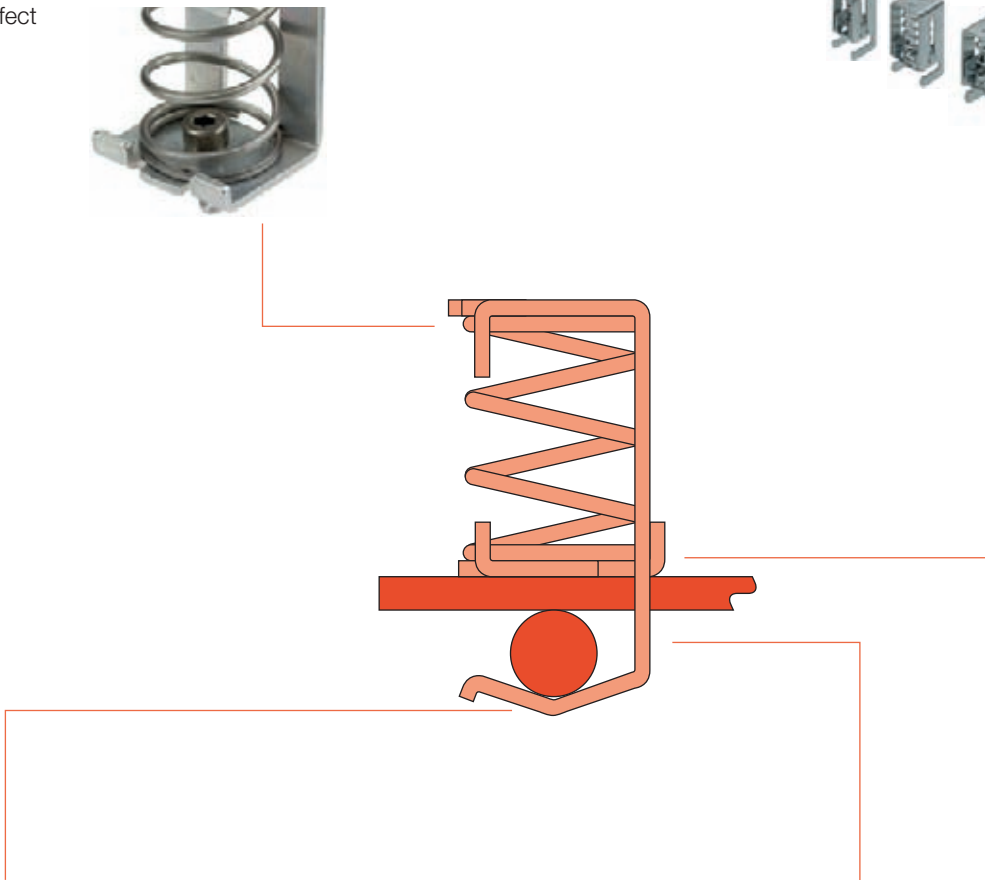

Reliable contact

- Changes in diameter (flow) of the conductor compensated for by the elastic behaviour of the clamping yoke for flexible adjustment to the cable diameter

Many options available

- Weidmüller offers a wide range of different fastenings for mounting shield connection terminals

Shield connection terminals KLBÜ for 10 x 3 mm busbars

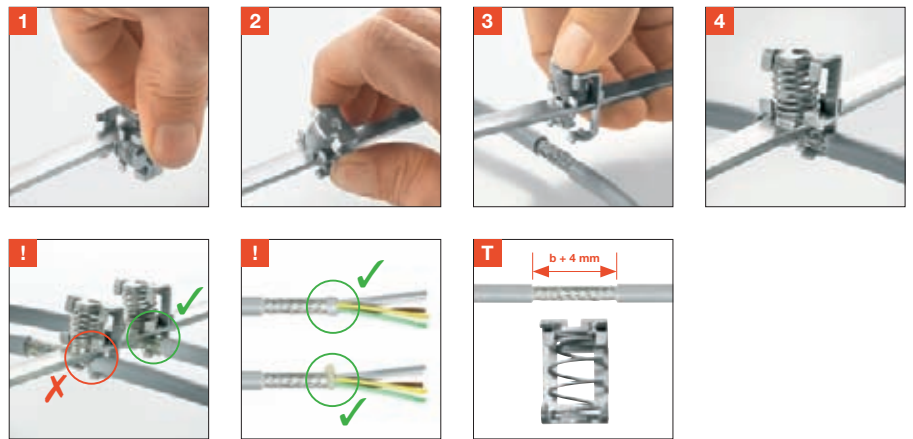
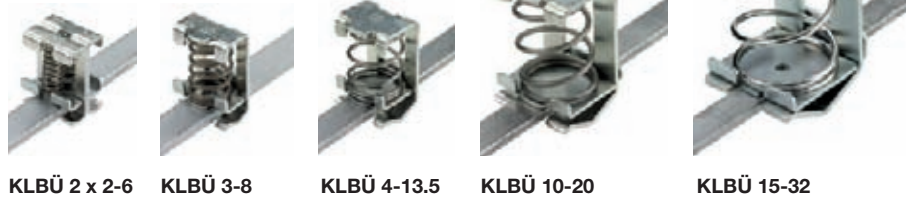
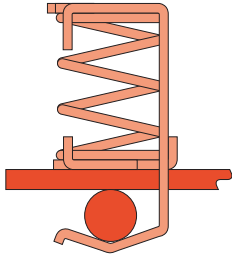

Clamping yoke

Cable fastened against the busbar from below

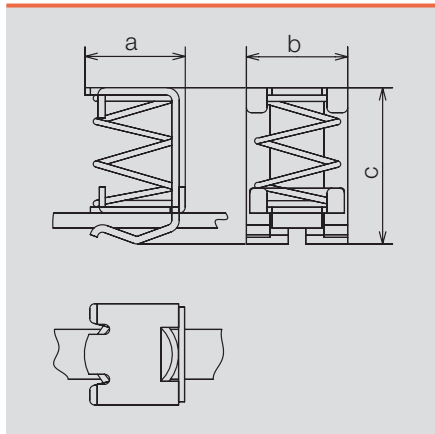

KLBÜ



Marking on the product: 
 Marking EN 50019:  Ex e II
 Marking EX-RL 94/9/EC: II 2 G D
 EC type testing certificate: DMT 02 ATEX E 024 U

Ordering data

Type	For cable diameter	Dimensions (a x b x c) mm	Qty.	Order No.
KLBÜ 2 x 2-6	2.0 ... 6.0 mm	15.0 x 18.0 x 24.0	10	1675350000
KLBÜ 3-8	3.0 ... 8.0 mm	13.0 x 18.0 x 26.0	10	1600480000
KLBÜ 4 x 13.5	4.0 ... 13.5 mm	20.0 x 20.5 x 31.5	10	1592810000
KLBÜ 10-20	10.0 ... 20.0 mm	25.0 x 26.0 x 40.0	10	1600490000
KLBÜ 15-32	15.0 ... 32.0 mm	36.0 x 32.0 x 63.9	10	1716300000

10 x 3 mm busbars	Length	Material	Qty.	Order No.
SSch 10 x 3 x 1000 Cu, Sn, Pb	1000.0 mm	Cu, Sn, Pb	1	0348900000
SSch 10 x 3 x 1000 Fe, Zn, 8B	1000.0 mm	Fe, Zn, 8B	1	1746130000

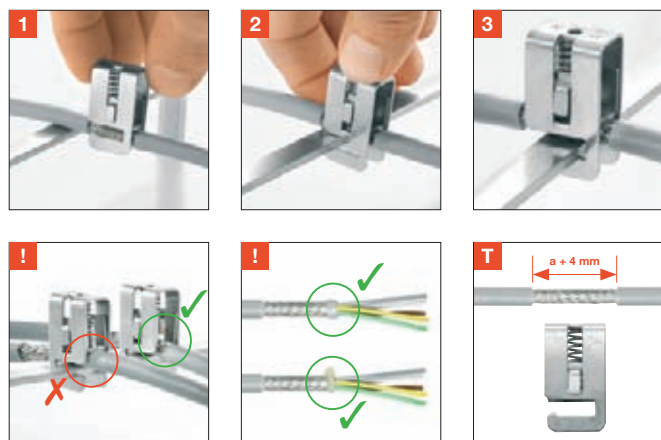
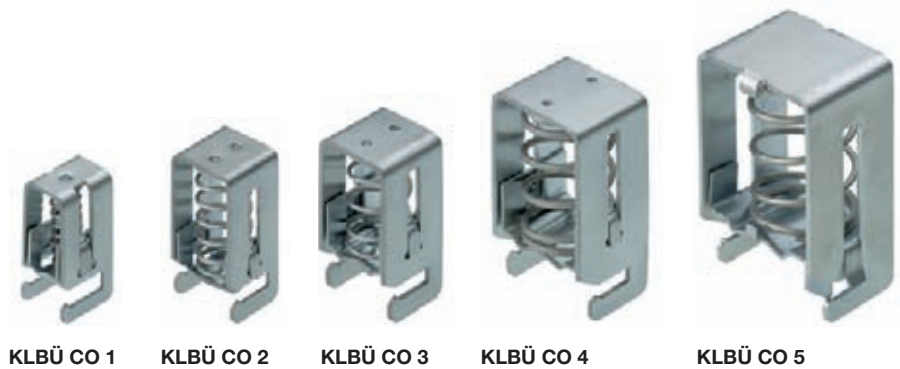
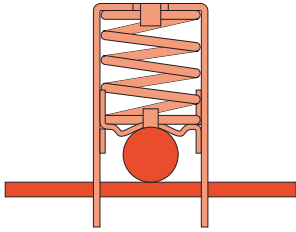

Clamping yoke

Cable fastened onto the busbar from above

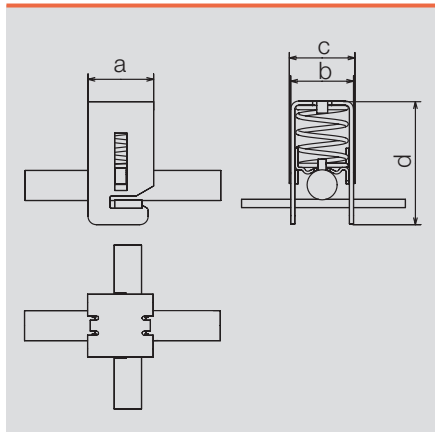

KLBÜ CO



Marking on the product: 
 Marking EN 50019:  Ex e II
 Marking EX-RL 94/9/EC: II 2 G D
 EC type testing certificate: DMT 02 ATEX E 024 U

Ordering data

Type	For cable diameter	Dimensions (a x b x c x d) mm	Qty.	Order No.
KLBÜ CO 1	3.0 ... 10.0 mm	18.0 x 12.0 x 13.2 x 32.0	10	1753311001
KLBÜ CO 2	4.0 ... 15.0 mm	18.0 x 20.0 x 21.1 x 41.6	10	1752131001
KLBÜ CO 3	10.0 ... 20.0 mm	25.0 x 23.0 x 24.0 x 45.0	10	1749151001
KLBÜ CO 4	15.0 ... 28.0 mm	25.0 x 31.0 x 32.0 x 56.0	10	1749161001
KLBÜ CO 5	20.0 ... 37.0 mm	32.0 x 40.0 x 42.7 x 64.5	10	1755081001

10 x 3 mm busbars	Length	Material	Qty.	Order No.
SSch 10 x 3 x 1000 Cu, Sn, Pb	1000.0 mm	Cu, Sn, Pb	1	0348900000
SSch 10 x 3 x 1000 Fe, Zn, 8B	1000.0 mm	Fe, Zn, 8B	1	1746130000

Shield connection terminals KLBÜ for 10 x 3 mm busbars

Busbar holders

Insulated mounting on TS 35

Type WSH 1

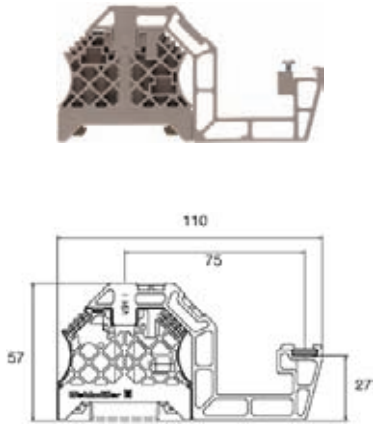

Horizontal mounting only

Type WSH 3/H/N

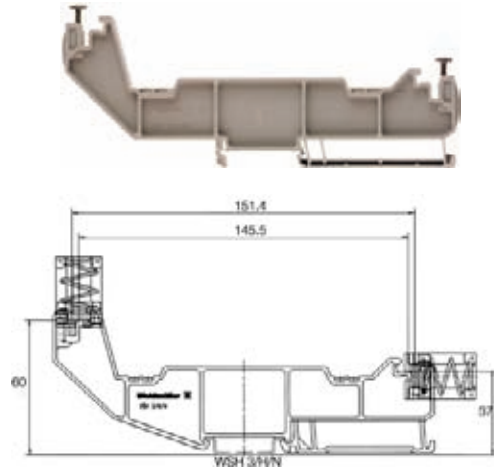

G

Type WSH 5

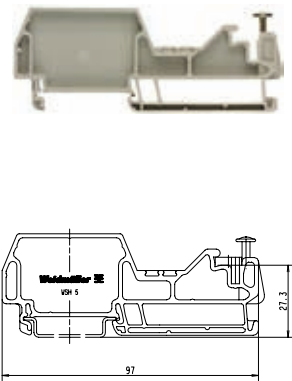

Type WSH 6

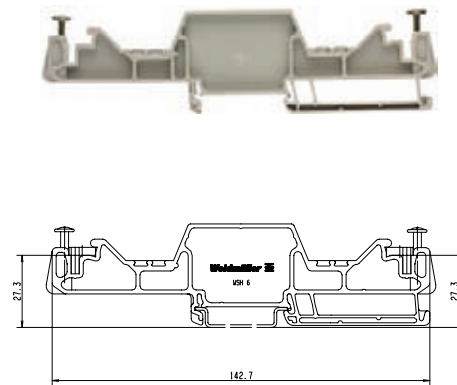

WSH

EC type testing certificate: DMT 02 ATEX E 024 U

Ordering data

Type	Width	Qty.	Order No.
WSH 1	8.0 mm	10	1068700000
WSH 3/H/N	8.0 mm	10	1715970000
WSH 5	8.0 mm	10	1080100000
WSH 6	8.0 mm	10	1080200000

10 x 3 mm busbars	Length	Material	Qty.	Order No.
SSch 10 x 3 x 1000 Cu, Sn, Pb	1000.0 mm	Cu, Sn, Pb	1	0348900000

Busbar holders

Conductive mounting on TS 35

TS 35-Clip

BS 35/WSH 2



Busbar connector

BFEH 1/WSH



Angled rail

SMSE WSH U1MT



Installation example 1

- One busbar
- 2 x WSH 19 MT busbar holder set

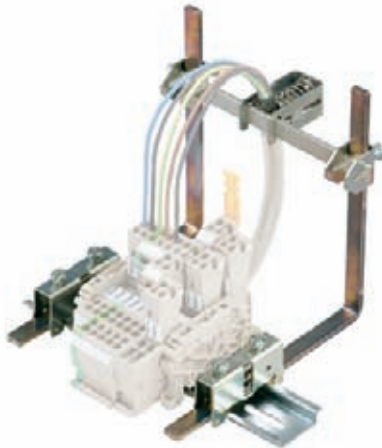

Installation example 2

- Two busbars
- 2 x WSH 18 MT busbar holder set

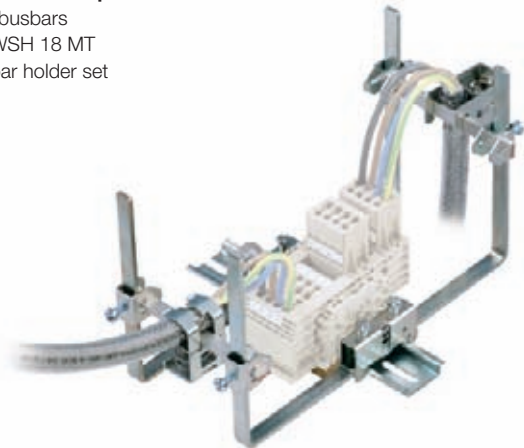

WSH

EC type testing certificate: DMT 02 ATEX E 024 U

Ordering data

TS 35-Clip	Dimensions (L x B x H) mm			Qty.	Order No.	
BS 35/WSH 2	52.0 x 37.0 x 13.0			10	1760720000	
Busbar connector	Dimensions (L x B x H) mm			Qty.	Order No.	
BFEH 1/WSH	20.0 x 31.0 x 13.5			10	1082400000	
Angled rail	Dimensions (L x B x H) mm			Qty.	Order No.	
SMSE WSH U1MT	134.0 x 13.0 x 134.0			10	1083900000	
Busbar holder sets	Contents (parts loose in plastic bag)				Qty.	Order No.
	BS 35/WSH 2	BFEH 1/WSH	SMSE WSH U1MT			
WSH 18 MT	1 ea.	2 ea.	2 ea.	10	1083100000	
WSH 19 MT	1 ea.	1 ea.	1 ea.	10	1083200000	
WSH 20 MT	1 ea.	1 ea.	1 ea. (straight)	10	1752950000	
10 x 3 mm busbars	Length	Material	Qty.	Order No.		
SSch 10 x 3 x 1000 Cu, Sn, Pb	1000.0 mm	Cu, Sn, Pb	1	0348900000		
SSch 10 x 3 x 1000 Fe, Zn, 8B	1000.0 mm	Fe, Zn, 8B	1	1746130000		

Shield connection terminals KLBÜ – Mounting directly on metal plate

Clamping yoke

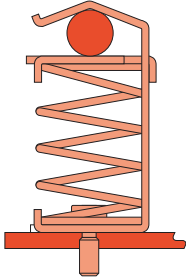

KLBÜ 3-8 SC

KLBÜ 4-13.5 SC

KLBÜ 10-20 SC

KLBÜ 15-32 SC

Drilling template KLBÜ 15-32 SC

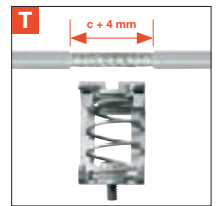
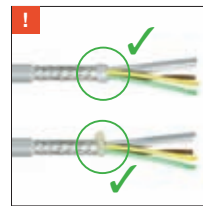
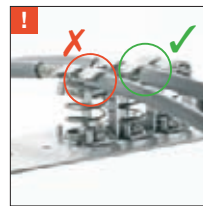
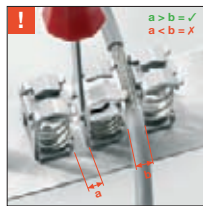
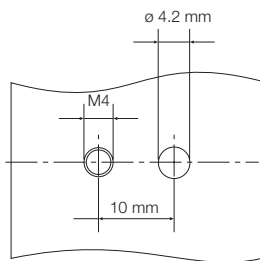

KLBÜ SC

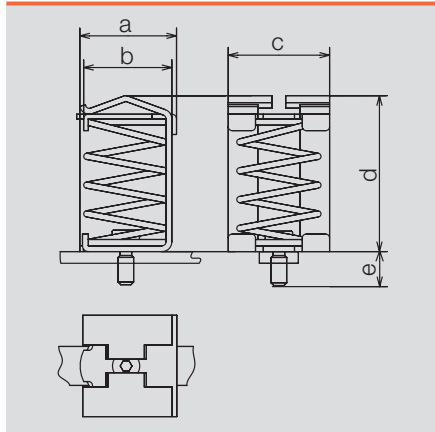

Marking on the product:
 Marking EN 50019: Ex e II
 Marking EX-RL 94/9/EC: II 2 G D
 EC type testing certificate: DMT 02 ATEX E 024 U

Ordering data

Type	For cable diameter	Thread length	Dimensions (a x b x c) mm	Qty.	Order No.
KLBÜ 3-8 SC	3.0 ... 8.0 mm	5.65 mm	13.5 x 11.5 x 18.0 x 26.0	10	1692261001
KLBÜ 4-13.5 SC	4.0 ... 13.5 mm	5.30 mm	20.0 x 17.8 x 20.3 x 31.4	10	1712311001
KLBÜ 10-20 SC	10.0 ... 20.0 mm	5.30 mm	24.8 x 23.0 x 26.0 x 40.0	10	1712321001
KLBÜ 15-32 SC	15.0 ... 32.0 mm	4.80 mm	36.0 x 33.3 x 32.0 x 64.0	10	1718341001

Operating tool	Qty.	Order No.
BTWZ KLBÜ	1	1742630000



Busbar holder / Spacer

Busbar holder



Set (WSH 4 MT) consisting of:
 - 1 busbar holder
 - 1 busbar connector (BFEH 1/WSH)

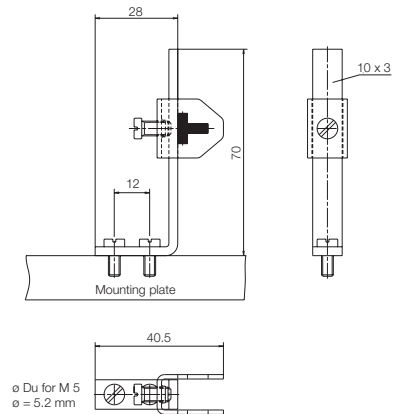

Spacer



M6 outer and inner thread
 (15 mm, 20 mm and 30 mm long)



WSH 4 MT / SP

EC type testing certificate: DMT 02 ATEX E 024 U

Ordering data

Busbar holder	Qty.	Order No.
WSH 4 MT	10	1079900000

Type	Length	Qty.	Order No.
SP 15, set of 2	15 mm	1	3896100000
SP 20, set of 2	20 mm	1	3896200000
SP 30, set of 2	30 mm	1	3896300000

Shield connection terminals KLBÜ – Mounting on TS 35

FM 4 foot / Clamping yoke holder

FM 4 foot



The KLBÜ SC clamping yokes (see page G.8) are screwed onto the **FM 4 foot**.



Clamping yoke holder



BS 35 II
(without KLBÜ)



BS 35 II / KLBÜ 3-8



BS 35 II / KLBÜ 3-8 / 2 x 2-6



FM 4 / BS 35 II

Ordering data

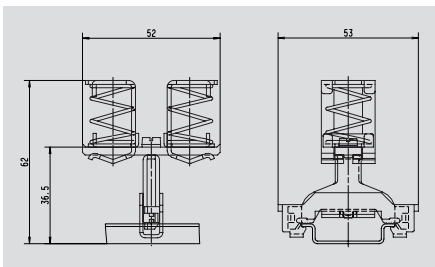
	Qty.	Order No.
FM 4 foot	40	0687900000



Clamping yoke holder	For cable diameter	Qty.	Order No.
BS 35 II	without KLBÜ	10	1723800000
BS 35 II / KLBÜ 3-8	3.0 ... 8.0 mm	10	1723810000
BS 35 II / KLBÜ 4-13.5	4.0 ... 13.5 mm	10	1723820000
BS 35 II / KLBÜ 3-8/2 x 2-6	3.0 ... 8.0 mm / 2.0 ... 6.0 mm	10	1749430000
BS 35 II / KLBÜ 2 x 3-8/2 x 2-6	3.0 ... 8.0 mm / 2.0 ... 6.0 mm	10	1768020000

Marking on the product: 
 Marking EN 50019:  Ex e II
 Marking EX-RL 94/9/EC: II 2 G D
 EC type testing certificate: DMT 02 ATEX E 024 U

Clamping yoke

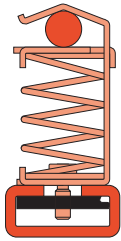

KLBÜ 3-8 CPF



KLBÜ 4-13.5 CPF



KLBÜ 10-20 CPF



KLBÜ 15-32 CPF

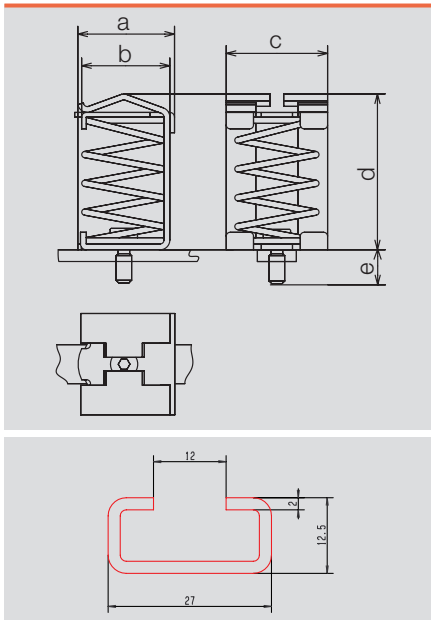

KLBÜ CPF



Ordering data

Type	For cable diameter	Dimensions (a x b x c x d) mm	Qty.	Order No.
KLBÜ 3-8 CPF	3.0 ... 8.0 mm	13.5 x 11.5 x 18.0 x 26.0	10	1752681001
KLBÜ 4-13.5 CPF	4.0 ... 13.5 mm	20.0 x 17.8 x 20.3 x 31.4	10	1752691001
KLBÜ 10-20 CPF	10.0 ... 20.0 mm	24.8 x 23.0 x 26.0 x 40.0	10	1752701001
KLBÜ 15-32 CPF	15.0 ... 32.0 mm	36.0 x 33.3 x 32.0 x 64.0	10	1752711001

C-rail	Qty.	Order No.
TS 27 x 12.5M / ST / F.ZN	10 m	1802690000

Marking on the product: 
 Marking EN 50019:  Ex e II
 Marking EX-RL 94/9/EC: II 2 G D
 EC type testing certificate: DMT 02 ATEX E 024 U

Busbars / Terminal rails

Busbars / Terminal rails

Busbar systems

Busbar overview	H.2
Busbars	H.3
Cable clamp, uninsulated	H.6
Cable clamp, insulated	H.7

Terminal rail systems

Overview Terminal rails	H.8
Terminal rails TS 15, TS 32, TS 35	H.10
End brackets	H.13
Terminal rail supports / Mounting feet	H.14

Busbars

In switchgears and controls, it may be necessary to bring the neutral conductor and the protective conductor together at a central point. Busbars are available for this purpose and can be used for connecting a large number of conductors in a confined space (up to 70 conductors on a 1 m busbar). The conductors are connected by means of a screw clamp or tension clamp. Busbars are held in position by pressure clamps or screw clamps onto the busbar holders. The cable clamps can be pushed on the busbar and adjusted to the entire wiring in the system. The busbars can be used unperforated in any lengths. They are fixed using the SH busbar holder which can, for longer busbars, also be positioned between the clamps.

In order to bring together neutral conductors and protective conductors at a central point, it is advantageous to use ZB cable clamps together with 10 x 3 or 6 x 6 busbars. The cable clamps can be pushed onto the busbar and adjusted to the entire wiring

in the system. The cable clamp serves as the protective conductor connection and can be supplied with green/yellow insulating caps. These caps indicate the protective function and marking tags allow clear identification of each conductor. If the cable clamps are used to connect neutral conductors, they can be marked with a blue insulating cap.

ZBE 6 can also be swivelled onto the busbar retrospectively

Cable clamps

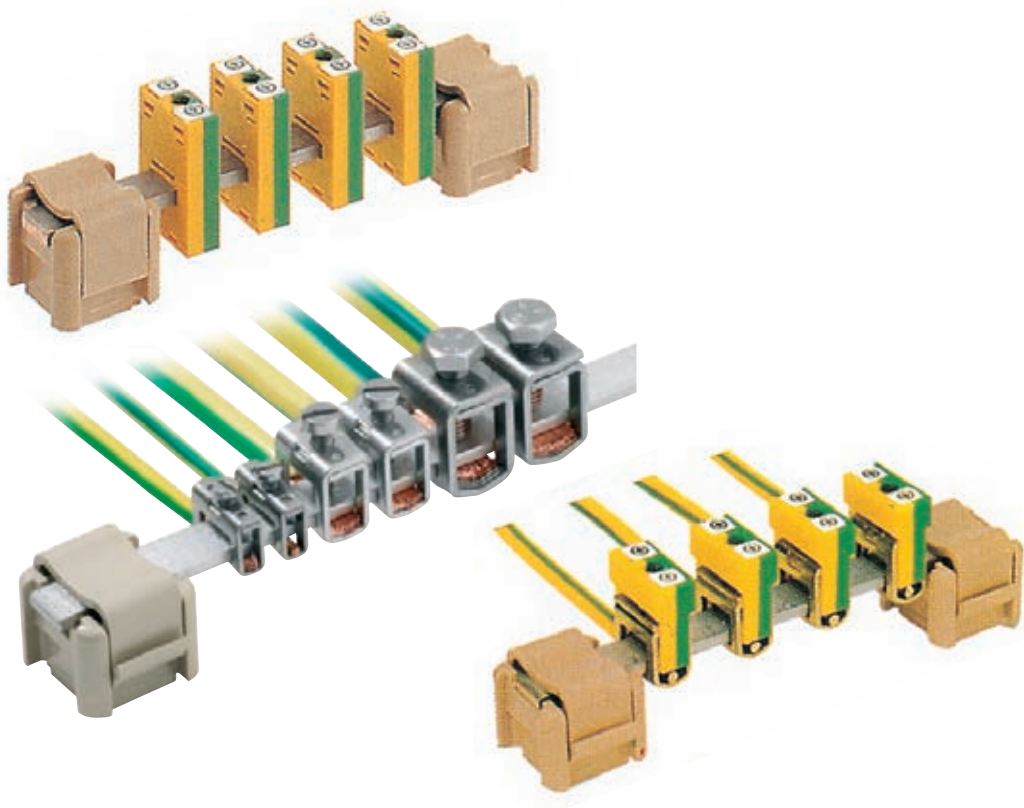

Busbars, unperforated

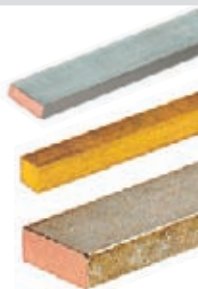

SSch

Type	Material	Cross-section	Length	Current carrying capacity	Qty.	Order No.
SSch 10 x 3	Copper, tin-plated	10 x 3 mm	1 m	140 A	1	0348900000
SSch 10 x 3	Steel, galvanised	10 x 3 mm	1 m		1	0438000000
SSch 10 x 3	Brass, blank	10 x 3 mm	1 m	100 A	1	0259800000
SSch 6 x 6	Copper, tin-plated	6 x 6 mm	1 m	140 A	1	0571300000
SSch 6 x 6	Brass, blank	6 x 6 mm	1 m	100 A	1	0571200000
SSch 15 x 6	Copper, tin-plated	15 x 6 mm	1 m	265 A	1	0357400000

Busbars, perforated

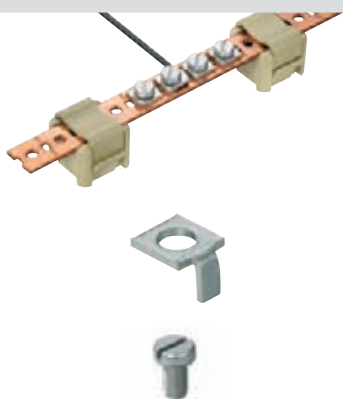

NSch / ESch

Type	Material	Cross-section	Length	Current carrying capacity	Qty.	Order No.
NSch 15 x 2	Copper, blank	15 x 2 mm	1 m	80 A	1	0280200000
ESch 12 x 2	Steel, galvanised	12 x 2 mm	1 m		1	0280300000

Pressure piece	Qty.	Order No.
DKSUE	100	0280100000
Clamping screw	Qty.	Order No.
BFSC M5 x 8	100	0296700000

Connection data NSch / ESch

Screw connection solid	0.5 ... 2.5 mm ²
Stripping length	9 mm
Cable lug connection	max. 16 mm ²
Max. current per connection	27 A

Busbar holders

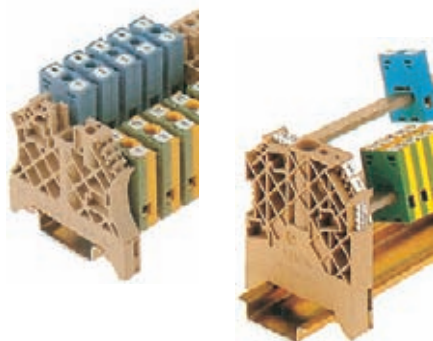

WEW

Type	For busbar cross-section	Qty.	Order No.
WEW 35/1	10 x 3, 6 x 6	50	1059000000
WEW 35/2	10 x 3, 6 x 6	100	1061200000

WEW 35/1 and WEW35/2 as busbar holder together with the ZB 4 G tension clamp

Connection element

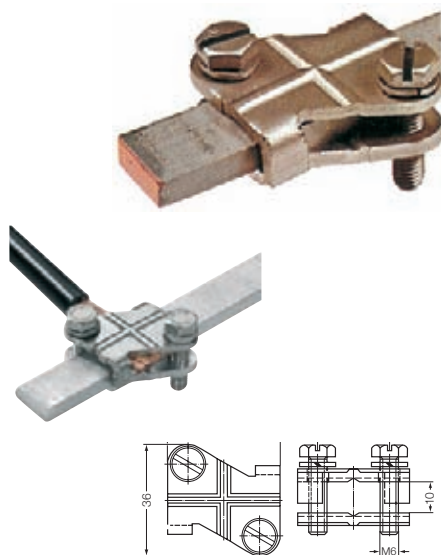

AK 95

Type	For busbar cross-section	Qty.	Order No.
AK 95	15 x 6 mm	10	0364200000

The AK 95 connection element is used as a tension clamp for 15 x 6 busbars Connection cross-sections:

e = 6...16 mm²

f = 6...50 mm²

m = 16...50 mm²

Busbars

Cable clamp, uninsulated



For 10 x 3 mm busbars



Connection cross-section:
 Solid 0.5 ... 6.0 mm²
 Flexible 0.5 ... 4.0 mm²
 Stranded -
 Clamping screw M 3
 Stripping length 16 mm

For retrofitting



Connection cross-section:
 Solid 1.0 ... 10 mm²
 Flexible 1.5 ... 10 mm²
 Stranded -
 Clamping screw M 4
 Stripping length 19 mm

Also for 10 x 5 mm busbar



Connection cross-section:
 Solid 1.5 ... 10 mm²
 Flexible 2.5 ... 10 mm²
 Stranded -
 Clamping screw M 4
 Stripping length 19 mm



Connection cross-section:
 Solid 2.5 ... 16 mm²
 Flexible 2.5 ... 16 mm²
 Stranded 16 ... 25 mm²
 Clamping screw M 4
 Stripping length 16 mm



Connection cross-section:
 Solid -
 Flexible 16 ... 35 mm²
 Stranded 16 ... 50 mm²
 Clamping screw M 6
 Stripping length 19 mm

For 6 x 6 mm busbar



Connection cross-section:
 Solid 0.5 ... 6.0 mm²
 Flexible 0.5 ... 4.0 mm²
 Stranded -
 Clamping screw M 3
 Stripping length 16 mm



Connection cross-section:
 Solid 2.5 ... 16 mm²
 Flexible 2.5 ... 16 mm²
 Stranded 16 ... 25 mm²
 Clamping screw M 4
 Stripping length 12 mm

ZB / ZBE

Type	Colour	Dimensions [mm]				Qty.	Order No.
		a	width	c	h1		
ZB 4, blank	-	11.7	5.6	16.0	10.0	50	0316500000
Insulating cap	blue					50	0475480000
Insulating cap	green / yellow					50	0475460000
ZBE 6, blank	-	19.5	8.2	19.5	19.0	50	0459500000
Insulating cap	blue					50	0526080000
Insulating cap	green / yellow					50	0526060000
ZB 10, blank	-	19.5	8.2	19.5	19.0	50	1261300000
ZB 16, blank	-	17.0	10.0	16.0	17.0	50	0316600000
Insulating cap	blue					50	0502980000
Insulating cap	green / yellow					50	0502960000
ZB 35, blank	-	21.0	14.4	18.4	20.5	20	0266500000
Insulating cap	blue					50	0502780000

ZB

Type	Colour	Dimensions [mm]				Qty.	Order No.
		a	b	c	h1		
ZB 4/6, blank		14.7	5.6	12.5	10.0	50	0556700000
ZB 16/6, blank		19.0	10.0	12.5	17.0	50	0556800000

Cable clamp, insulated



For 10 x 3 mm busbars

	Connection cross-section:	
	Solid	0.5 ... 6.0 mm ²
	Flexible	0.5 ... 4.0 mm ²
	Stranded	-
	Clamping screw	M 3
	Stripping length	16 mm

For retrofitting

	Connection cross-section:	
	Solid	1.0 ... 10 mm ²
	Flexible	1.5 ... 10 mm ²
	Stranded	-
	Clamping screw	M 4
	Stripping length	19 mm

	Connection cross-section:	
	Solid	2.5 ... 16 mm ²
	Flexible	2.5 ... 16 mm ²
	Stranded	16 ... 25 mm ²
	Clamping screw	M 4
	Stripping length	16 mm

	Connection cross-section:	
	Solid	-
	Flexible	16 ... 35 mm ²
	Stranded	16 ... 50 mm ²
	Clamping screw	M 6
	Stripping length	19 mm

Tension clamp connection

	Connection cross-section:	
	Solid	0.5 ... 4.0 mm ²
	Flexible	0.5 ... 2.5 mm ²
	Stranded	-
	Stripping length	10 mm

For 6 x 6 mm busbar

	Connection cross-section:	
	Solid	0.5 ... 6.0 mm ²
	Flexible	0.5 ... 4.0 mm ²
	Stranded	-
	Clamping screw	M 3
	Stripping length	16 mm

	Connection cross-section:	
	Solid	2.5 ... 16 mm ²
	Flexible	2.5 ... 16 mm ²
	Stranded	16 ... 25 mm ²
	Clamping screw	M 4
	Stripping length	12 mm

ZB / ZBE / ZF

Type	Colour	Dimensions [mm]				Qty.	Order No.
		a2	width	d	h2		
ZB 4 G GN/GE	green/yellow	27.0	7.6	19.7	15.5	50	0322160000
ZB 4 G BL	blue	27.0	7.6	19.7	15.5	50	0322180000
ZB 4 G SW	black	27.0	7.6	19.7	15.5	50	0322110000
ZB 4K GN/GE	grün/gelb	18.5	6.0	19.0	13.0	50	0475360000
ZB 4K BL	blue	18.5	6.0	19.0	13.0	50	0475380000
ZBE 6K GN/GE	green/yellow	27.0	8.0	22.5	23.0	50	0525960000
ZBE 6K BL	blue	27.0	8.0	22.5	23.0	50	0525980000
ZBE 6K SW	black	27.0	8.0	22.5	23.0	50	0525910000
ZB 16K GN/GE	green/yellow	24.0	10.0	19.2	20.0	50	0502860000
ZB 16K BL	blue	24.0	10.0	19.2	20.0	50	0502880000
ZB 35K GN/GE	green/yellow	25.0	14.4	32.0	20.5	20	0502660000
ZB 35K BL	blue	25.0	14.4	32.0	20.5	20	0502680000
ZB 35K SW	black	25.0	14.4	32.0	20.5	20	0502610000
ZF 4 S	beige	22.0	6.1	24.5	-	50	1814680000
ZF 4 S BL	blue	22.0	6.1	24.5	-	50	1814660000
ZF 4 S GN/GE	green/yellow	22.0	6.1	24.5	-	50	1814670000

ZB

Type	Colour	Dimensions [mm]				Qty.	Order No.
		a2	b	d	h2		
ZB 4/6K GN/GE	green/yellow	21.2	6.0	25.0	14.0	50	0565460000
ZB 4/6K BL	blue	21.2	6.0	25.0	14.0	50	0565480000
ZB 16/6K GN/GE	green/yellow	26.0	9.7	25.0	20.0	50	0569660000

Terminal rail systems

Both active and passive components and intelligent modules are mounted on terminal rails – a method which has proven its worth over the years. But it is only after the use of certain consumables – which are frequently not taken into consideration – that electrical installation is finally completed. In this chapter, users will find a range of terminal rails and profile rails for component installation together with end brackets for holding and isolating the components. This guarantees firm installation and isolation. Weidmüller supplies components which show perfect functional compatibility.

Terminal rails are made of either steel, stainless steel, aluminium, copper or plastic, depending on the area of application.

Stainless steel

Stainless steel is a collective noun for all kinds of steel (alloys) which are smelted in a special process and have a high degree of purity. Stainless steel has much-enhanced resistance to corrosion. Weidmüller's stainless steel terminal rails have the following composition: X5 CrNi 18-10 stainless steel (i.e. ~ 18 % chromium, ~ 10 % nickel).

Aluminium

Aluminium is second only to copper in its electrical conductivity. One advantage is its light weight. Aluminium oxidises quickly in air; thus passivated, it offers excellent corrosion protection.

Copper

Copper, a heavy metal, has the best electrical conductivity of all metals used. As it is a soft metal, Weidmüller's terminal rails are 2.3 mm thick.

Plastic

The plastic terminal rail scores on two counts: firstly, its insulating properties, and secondly, its low weight. This leads to its use in special applications where, for example, clearance and creepage distances with respect to the mounting plate cannot be achieved with the standard terminal rails.

Steel

Weidmüller started developing RoHS-compliant surfaces at a very early stage to meet the requirements of EU directives. This commitment is now paying off because Weidmüller products comply with the statutory instruments at an early date and provide you, the customer, with the customary, high Weidmüller quality. All the yellow-passivated surfaces so well known to users will in future be replaced by terminal rails with the new **WIN-Q** surface finish. This name stands for the Weidmüller quality, in other words excellent surface protection and, at the same time, excellent electrical properties.

A terminal rail can also be used as a protective conductor busbar. Weidmüller PE / earth terminals in the W-Series, Z-Series, I-Series, SAK- and AKZ-Series comply with requirements stipulated in IEC 60 947-7-2. According to VDE 0100 part 540, for conductors with cross-sectional areas exceeding 10 mm², both protective and neutral conductors may be grouped together as a single category of conductors designated PEN.

If a terminal rail is used as a PEN busbar, the following criteria must be observed:

- Only E-Cu or aluminium profiles are allowed
- Short-circuit currents and thermal rated currents must be taken into account
- The terminal rails are to be insulated as a contribution to protective insulation

All unperforated terminal rails can be provided with fixing holes (state dimensions h and l₂).
Possible diameters are 3.5 / 5.6 / 5.5 / 7 mm.

All unperforated steel rails can also be supplied with welded on steel studs (state dimension a and required studs).

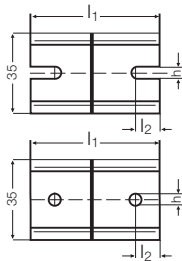

TS 15

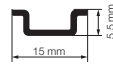

TS 32

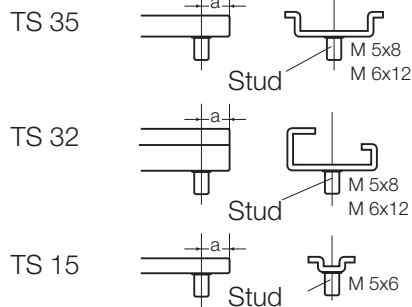
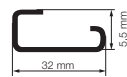

TS 35 x 7.5



TS 35 x 15



Terminal rails

TS 15 terminal rail

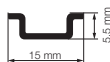

Unperforated

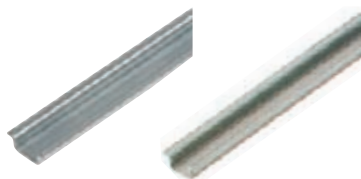

TS 15 x 5

Aluminium	Short-circuit strength	Material thickness	Length	Qty.	Order No.
TS 15x5 2M/AL/BK	16 mm ²	1 mm	2 m	10 m	0134700000
(max. permissible rated current for PEN function = 76 A)					
Steel, galvanised and passivated					
TS 15x5 2M/ST/ZN	10 mm ²	1 mm	2 m	2 m	0514200000

With slotted hole

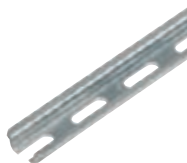

Aluminium	Short-circuit strength	Material thickness	Length	Qty.	Order No.
TS 15x5/LL 2M/AL/BK	16 mm ²	1 mm	2 m	2 m	0217900000
(max. permissible rated current for PEN function = 76 A)					
Steel, galvanised and passivated					
TS 15x5/LL 2M/ST/ZN	10 mm ²	1 mm	2 m	2 m	0117500000
TS 15x5/LL 1M/ST/ZN	10 mm ²	1 mm	1 m	10 m	0117510000

H

TS 32 terminal rail



Unperforated



TS 32 x 15

Aluminium	Short-circuit strength	Material thickness	Length	Qty.	Order No.
TS 32X15 2M/AL/BK	70 mm ²	1.5 mm	2 m	2 m	0169300000
(max. permissible rated current for PEN function = 192 A)					
Steel, galvanised and passivated					
TS 32X15 2M/ST/ZN	35 mm ²	1.5 mm	2 m	2 m	0122800000

Copper

TS 32X16.2 2M/CU/BK	120 mm ²	2.1 mm	2 m	2 m	0364300000
(max. permissible rated current for PEN function = 269 A)					

Stainless steel

TS 32X15 2M/CRN	35 mm ²	1.5 mm	2 m	2 m	0293220000
-----------------	--------------------	--------	-----	-----	------------

With slotted hole

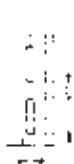

Steel, galvanised and passivated	Short-circuit strength	Material thickness	Length	Qty.	Order No.
TS 32X15/LL 2M/ST/ZN	35 mm ²	1.5 mm	2 m	2 m	0514400000

TS 35 x 7,5 terminal rail



Unperforated

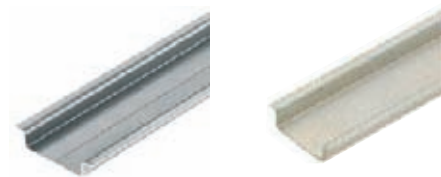

TS 35 x 7.5

Aluminium	Short-circuit strength	Material thickness	Length	Qty.	Order No.
TS 35X7.5 2M/AL/BK (max. permissible rated current for PEN function = 125 A)	35 mm ²	1 mm	2 m	2 m	0330800000
Steel, galvanised and passivated					
TS 35X7.5 2M/ST/ZN	16 mm ²	1 mm	2 m	2 m	0383400000
TS 35X7.5 1M/ST/ZN	16 mm ²	1 mm	1 m	10 m	0383410000
Stainless steel					
TS 35X7.5 2M/CRN	16 mm ²	1 mm	2 m	2 m	1747350000

With slotted hole

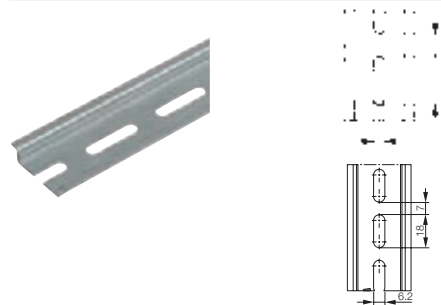

Steel, galvanised and passivated	Short-circuit strength	Material thickness	Length	Qty.	Order No.
TS 35X7.5/LL 2M/ST/ZN	16 mm ²	1 mm	2 m	2 m	0514500000
TS 35X7.5/LL 1M/ST/ZN	16 mm ²	1 mm	1 m	10 m	0514510000

TS 35X7.5/LL/6 2M/ST/ZN	16 mm ²	1 mm	2 m	2 m	0514570000
-------------------------	--------------------	------	-----	-----	------------

TS 35 x 15 terminal rail



Unperforated

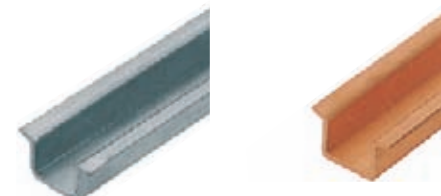

TS 35 x 15

Copper	Short-circuit strength	Material thickness	Length	Qty.	Order No.
TS 35X15/2.3 2M/CU/BK (max. permissible rated current for PEN function = 309 A)	150 mm ²	2.3 mm	2 m	2 m	0270100000
Steel, galvanised and passivated					
TS 35X15/2.3 2M/ST/ZN	50 mm ²	2.3 mm	2 m	2 m	0498000000
Aluminium					
TS 35X15/2.3 2M/AL/BK (max. permissible rated current for PEN function = 192 A)	70 mm ²	2.3 mm	2 m	2 m	1848290000

Unperforated



Steel, galvanised and passivated	Short-circuit strength	Material thickness	Length	Qty.	Order No.
TS 35X15 2M/ST/ZN	25 mm ²	1.5 mm	2 m	2 m	0236400000

With slotted hole

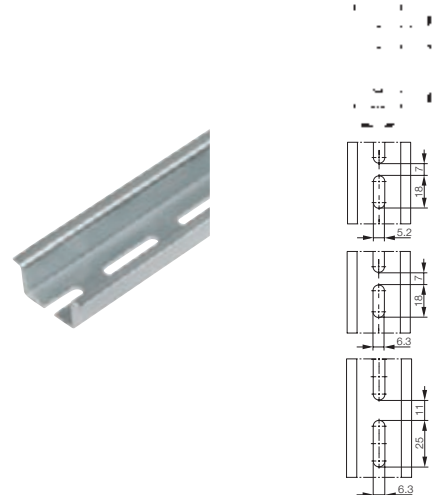

Steel, galvanised and passivated	Short-circuit strength	Material thickness	Length	Qty.	Order No.
TS 35X15/LL 2M/ST/ZN	25 mm ²	1.5 mm	2 m	2 m	0236500000
TS 35X15/LL 1M/ST/ZN	25 mm ²	1.5 mm	1 m	10 m	0236510000

TS 35X15LL/5 2M/ST/ZN	25 mm ²	1.5 mm	2 m	2 m	1837380000
-----------------------	--------------------	--------	-----	-----	------------

TS 35X15/LL/6x18 2M/ST/ZN	25 mm ²	1.5 mm	2 m	2 m	1805980000
---------------------------	--------------------	--------	-----	-----	------------

TS 35X15/LL/6x25 2M/ST/ZN	25 mm ²	1.5 mm	2 m	2 m	1866290000
---------------------------	--------------------	--------	-----	-----	------------

Terminal rails

TS 35 x 15 terminal rail

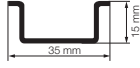

Unperforated



TSK 35 x 15

Plastic PVC RAL 7035	Length	Qty.	Order No.
TSK 35X15 2M PVC/GR	2 m	2 m	0514300000

End brackets

For TS 15 terminal rail

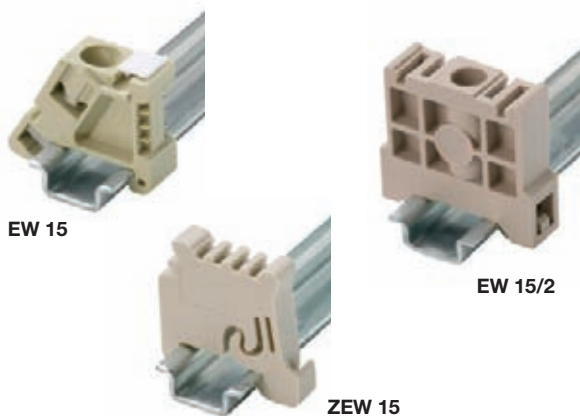

Polyamide 66, screw-in	Colour	Torque	Qty.	Order No.
EWK AKA 2.5	beige	0.4 Nm	50	0348660000
EW 15	beige	0.4 Nm	50	0382860000

Polyamide with fibreglass, screw-in	Colour	Torque	Qty.	Order No.
EW 15/2	dark beige	0.4 Nm	50	1071900000

Polyamide 66, screwless	Colour	Torque	Qty.	Order No.
ZEW 15	beige		20	7920340000

For terminal rail TS 32

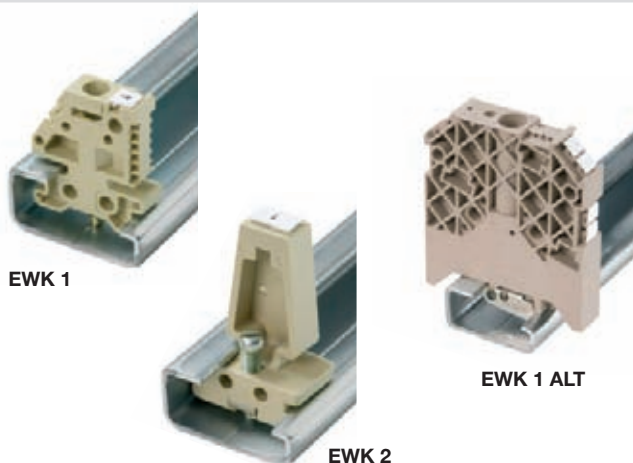

Polyamide 66, screw-in	Colour	Torque	Qty.	Order No.
EWK 2	beige	1.2 Nm	50	0199360000
EWK 1 TS 32 M4X18	beige	1.2 Nm	50	0206160000
EWK 1 ALT	beige	0.6 Nm	50	0495160000

Polyamide with fibreglass, screw-in	Colour	Torque	Qty.	Order No.
WEW 32/1	dark beige	0.5 Nm	50	1067600000

For terminal rail TS 35

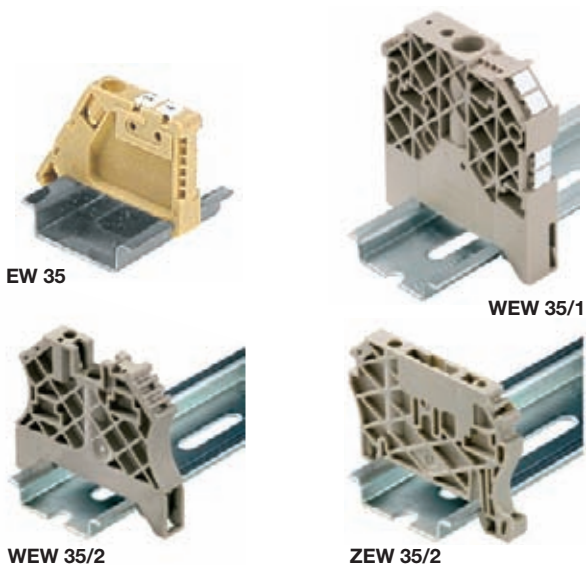

Polyamide 66, screw-in	Colour	Torque	Qty.	Order No.
EW 35	beige	0.5 Nm	50	0383560000
EW 35 GR	grey	0.5 Nm	50	0383530000

Polyamide with fibreglass, screw-in	Colour	Torque	Qty.	Order No.
WEW 35/1	dark beige	1.2 Nm	50	1071900000
WEW-35/2	dark beige	0.5 Nm	100	1061200000

Polyamide 66, screwless	Colour	Torque	Qty.	Order No.
ZEW (6 mm)	beige		20	9540000000
ZEW 35/2 (8 mm)	beige		20	8630740000

Terminal rails

Terminal rail supports / Mounting feet

Terminal rail supports

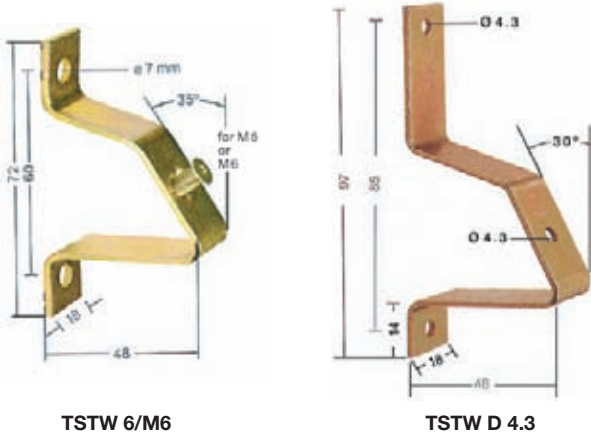

TSTW 6/M6

TSTW D 4.3

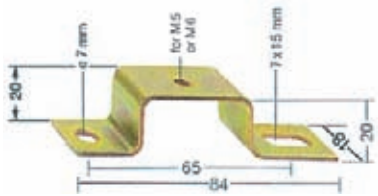

TST

	Thread	Qty.	Order No.
TSTW 5/M5	M5	10	0178100000
TSTW 5/M5 galvanised	M6	10	1779100000
TSTW 6/M6	M5	10	0164000000
TSTW D 4.3	Hole ø 4.3 mm	10	1610110000

Terminal rail supports of type **TSTW** are used for angled fixing of terminal rails at an angle of 35°.

TST 2/M5	M5	10	1286600000
TST 2/M6	M6	10	0101700000

The **TST** terminal rail support is used for assembly of terminal rails in a frame or over a cut-out

Fixing screws			
FKSC M5x8 Ø9		50	0295900000
FKSC M6x8 Ø9		50	0642600000
FKSC M6x12 Ø9		50	0353500000

Weidmüller supplies fixing screws with hexagonal sockets and a very low head for the terminal rail supports so that the terminals can also be fitted over the screw.

Terminal rail supports / Mounting feet

Mounting feet



FM



MOFU 35/LO/1



MOFU 35

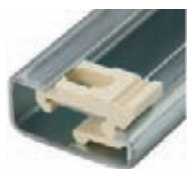

MB



Clip-on foot, steel for TS 35	Thread	Qty.	Order No.
FM 4	M4	40	0687900000
FM 5	M5	40	0636800000
FM 6	M6	40	0636900000
FM 4.2	Hole ø 4.2 mm	40	1724580000

Mounting foot, PA orange for TS 35		Qty.	Order No.
MOFU 35/LO/1	with holes	20	0646260000
MOFU 35		20	0495660000

Sliding nut for TS 32		Colour	Qty.	Order No.
MB M3/M5	M3 und M5	creme	20	0503500000
MB M5/M3	M5 und M3	black	20	0553400000
MB M6/M4	M6 und M4	grey	20	0334900000

The sliding nut for the RS 32 terminal rail has two threaded holes for screws M3 + M5 / M6 + M4 / M5 + M3. It is used to fasten components which cannot be slotted directly onto the TS 32, in particular the smaller TS 15 top hat rail. This enables, for example, mini-terminals to be snapped onto the TS 15 first, and this rail is then fastened together with the terminals to the TS 32 using the sliding nut.

Accessories

Accessories

Accessories

Overview	I.2
Visual separation – side covers	I.4
Colour coding options	I.6
Potential distribution	I.8
Testing/Checking	I.14
Protective covers	I.16
Accessories for modular disconnect test terminals	I.20

The extra functions

Weidmüller can supply an extensive range of accessories for users of the SAK series of modular terminals. These help to provide the right solution for all manner of tasks, even those outside the scope of standard functions.

And of course, the accessories have to satisfy the same high standards of quality as the modular terminals themselves.

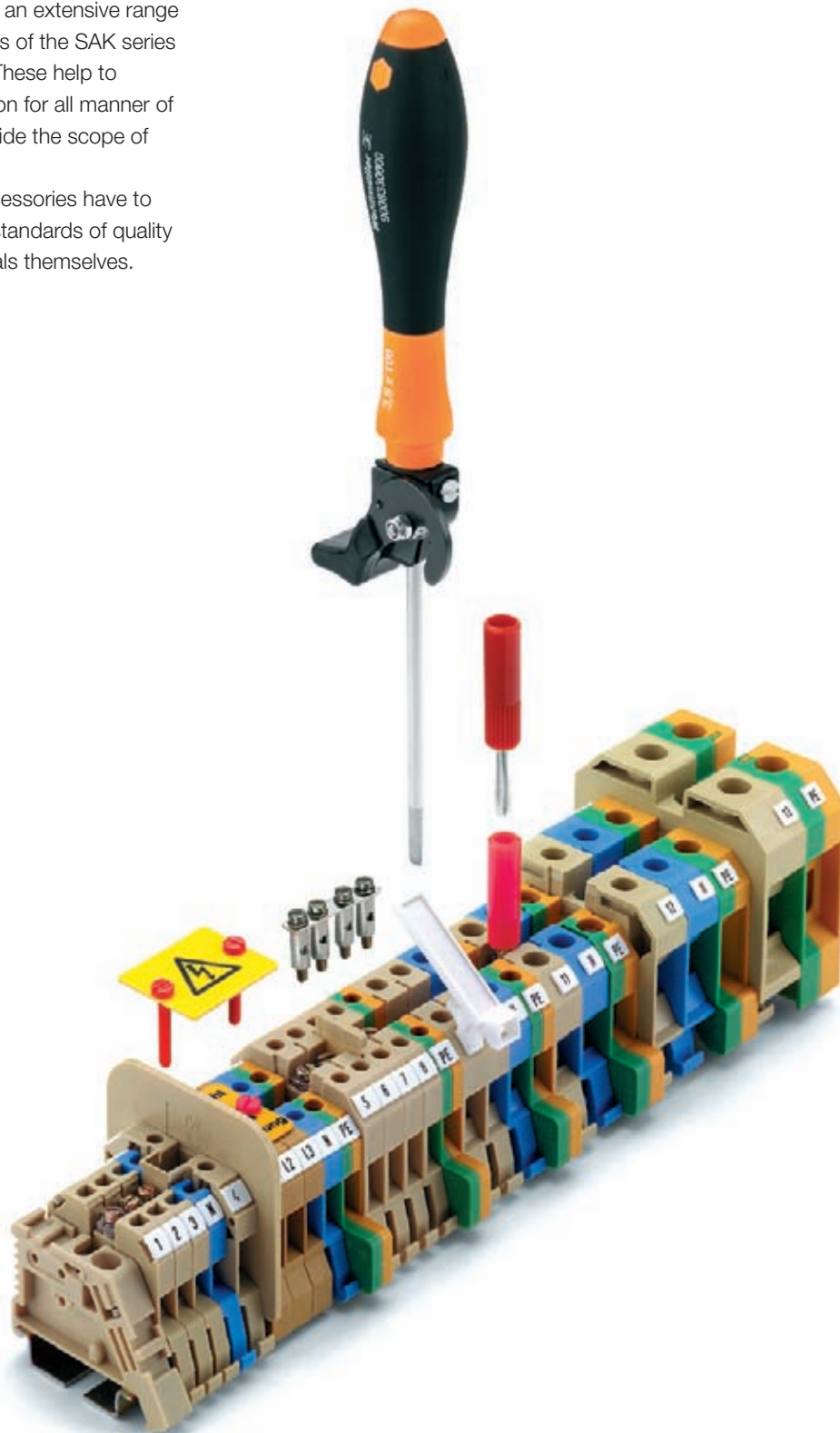

Visual separation – side covers

Page I.4



To guarantee protection against fingers coming into contact with live parts when working with modular terminals, open sides are blocked off with end cover plates and partition plates. But in addition, end cover plates and partition plates are available in various colours and so can be used to create a visual distinction between different circuits.

Colour coding options

Page I.6



Another helpful feature of the accessories for modular terminals with screw connections are the different colours available.

Potential distribution

Page I.8



Some 60% of all modular terminals are cross-connected. Weidmüller can supply a wide range of solutions.

Testing / Checking

Page I.14

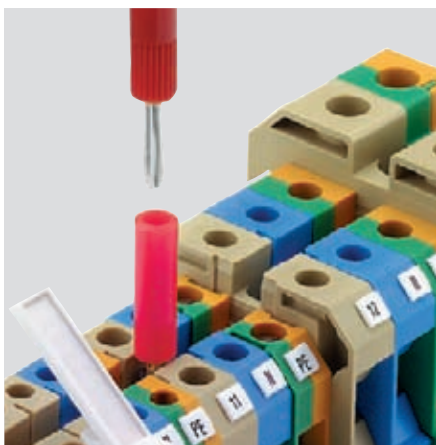

Weidmüller test plugs and sockets guarantee that the necessary tests can be carried out on the installation.

Protective covers

Page I.16



Electrical installations must be safe at all times. Therefore, Weidmüller can supply a large range of protective cover strips and plates, plus labelling systems.

Accessories for modular disconnect test terminals

Page I.20

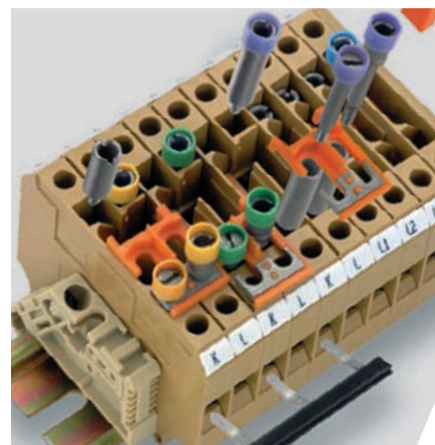

Special applications call for special solutions.

Visual separation – side covers

End cover plates



Apart from a few exceptions, the last terminal of a terminal strip must be covered with an AP end cover plate. And end cover plates are also required within a terminal strip containing terminals of different sizes.

The overall dimensions of the end cover plates match the sizes of the associated terminals. The end cover plate is held in place by an end bracket.

AP end cover plates

Type		Order No.	for terminal type:
AP		0150960000	SAKD 2.5 N
AP 2.5	KrG	0279520000	SAK 2.5 and TT
AP 2.5	KrS	0279530000	SAK 2.5 L and LL
AP	KrG	0117920000	SAK 4, 6 N, 10, SAKC 4, NT 2, SLK 1, SAK 4 S and SS
AP 16	KrG	0271120000	SAK 16
AP 16	PA	0271160000	
AP 35	KrG	0303620000	SAK 35, 35 N
AP 35	PA	0303660000	
AP 70	KrG	0340920000	SAK 70
AP 70	PA	0340960000	
AP 95	KrG	0550920000	SAK 95
AP 2.5	KrG	0309220000	SAK 2.5 L
AP	PA	0438560000	DK 4/380 Q
AP	KrG	0266420000	AST 1, 5 and 5 T
AP	KrG	0298120000	AST 3 and 4
AP	PA	0582560000	AST 6, TOP 2.5
AP	PA	0483460000	TOP 4 SF / FF
AP	KrG	0294420000	AKZ 4
AP	PA	0294460000	AKZ 4 S and SS, AKZ 4, AKZ 4 L and LL, AKZ 4 T
AP	KrG	0146720000	SAKT 1, SAKC 10, SAKB 10, SAKS 7
AP	KrG	0329120000	SAKT 2
AP	PA	0211360000	SAKR, SAKR-L, SAKR-D
AP	KrG	0134220000	SAKA 10
AP	KrG	0191320000	SAKS 1 and 3
AP	PA	0340560000	AKZ 1.5, AKZ 1.5 T
AP	PA	0329660000	AKZ 1.5 W
AP	KrS	0131730000	SAKH 6 - 10

End clamp plates

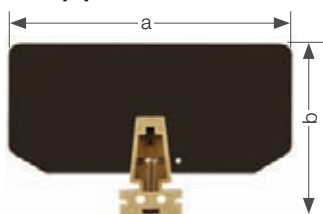

Dimensions (mm)

EP end clamp plates for SAKG

Material	Thickness	a	b	Order No.	for terminal type:
for mounting on TS 32					
HP	2	120	75.5	0205100000	SAKG 28, 32 II, 70
HP T*	2	120	75.5	0205200000	
HP	2	160	90.5	0205300000	SAKG 32 I + III,
HP T*	2	160	90.5	0205400000	40, 46, 54
for mounting on TS 35					
HP	2	120	75.5	0180500000	SAKG 32 II, 70
HP T*	2	120	75.5	0180600000	
HP	2	160	90.5	0180700000	SAKG 32 I + III,
HP T*	2	160	90.5	0180800000	40, 46, 54

T* = suitable for tropical applications

End clamp plates

End clamp plate with mounting bracket EP ... /32

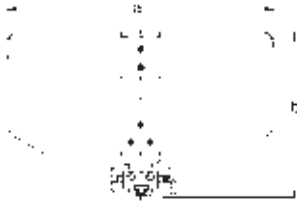

End clamp plate with mounting bracket EP ... /35



EP end clamp plates

Type	a	b	Order No.	for terminal type:
EP 1	120	75.5	0271800000	SAKG 28 and SAKG 70
EP 2	160	90.5	0271900000	SAKG 32, 40, 46 and 54
EP 1/35	120	76.5	1381600000	SAKG 32 and SAKG 70
EP 2/35	160	91.5	0182000000	SAKG 32, 40, 46 and 54

Strain relief clip

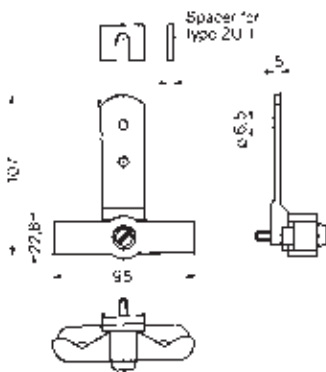

Strain relief clip for gripping cables up to 30 mm dia. Attach the strain relief clip between TS and mounting surface using the TS fixing screw. Fit the spacer to suit with the second fixing screw.

ZU 1

Material	Qty.	Order No.
ZU 1	2	0240600000

Colour coding options

End cover plates



Protection against contact with live parts

Apart from a few exceptions, the last terminal of a terminal strip must be covered with an AP end cover plate. And end cover plates are also required within a terminal strip containing terminals of different sizes.

This guarantees protection against contact with live parts. The modular terminals are finger-touch safe (to DIN VDE 0106-100).

Visual separation

Coloured end cover plates are frequently used to create a visual distinction between different circuits

Guaranteeing the operating voltage

End cover plates can also be used to maintain the necessary clearance and creepage values and thus guarantee the operating voltage for the application. For example, if cross-connection sets are positioned directly adjacent one another.

Matching profiles

The overall dimensions of the end cover plates match the sizes of the associated terminals.

Installation

Spigots on the end cover plate enable it to be simply clipped into the corresponding modular terminal. The matching holes in the modular terminal ensure that the end cover plate is positioned exactly to match the profile of the terminal.

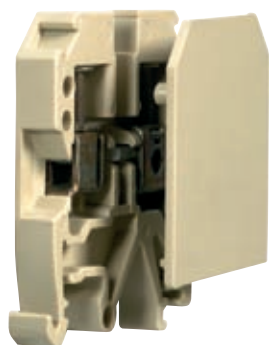

Visual separation – side covers

Type	Colour	Qty.	Order No.	Type	Colour	Qty.	Order No.
AP SAK4-10 DB	dark beige	20	0105100000	AP SAK35 KRG	dark beige	10	0303620000
AP SAK4-10 OR	orange	20	0105160000	AP AKZ2.5 BL	blue	50	0697380000
AP ASK1 OR	orange	20	0105360000	AP RSF2 KRG	dark beige	10	0301420000
AP DKT4 PA	beige	20	0687560000	AP SAK2.5	beige	20	0279560000
AP AKZ2.5K	beige	50	0697260000	AP SAK2.5 KRG	dark beige	20	0279520000
AP AKZ2.5	beige	50	0697360000	AP DLD2.5 BL	blue	20	1317680000
AP DKIT4	beige	20	0635060000	AP AKZ1.5W	beige	20	0329660000
AP SAK4-10 RT	red	20	0117900000	AP SAKT2 KRG	dark beige	20	0329120000
AP SAK4-10 KRG/BL	blue	20	0117970000	AP AST3+4 KRG	dark beige	20	0298120000
AP SAK4-10 BL	blue	20	0117980000	AP DK4Q BL	blue	20	1397180000
AP SAKH 4EX	black	20	0408730000	AP SAK2.5L KRG	dark beige	20	0309220000
AP SAKH6-10 EP/SW	black	20	0131700000	AP RSF3	beige	10	0270460000
AP DUSA4/35	beige	20	0401360000	AP RSF1 KRG	dark beige	10	0270420000
AP SAKB/C/T BE	beige	20	0146760000	AP AST1+5 KRG	dark beige	20	0266420000
AP SAKD2.5N BL	blue	20	0150980000	AP AST1+5	beige	20	0266460000
AP AKA2.5 KRG/BL	blue	50	0162570000	AP SAK16 KRG	dark beige	20	0271120000
AP SAK4-10 KRG/DB	dark beige	20	0177600000	AP SAKT4 KRG	dark beige	20	0244920000
AP SAKS1+3 KRG/DB	dark beige	20	0191300000	AP SAK16	beige	20	0271160000
AP SAKR BE	beige	20	0211360000	AP SAK4-10	beige	20	0117960000
AP 70 SAK70 KRG	dark beige	10	0340920000	AP SAK4-10 KRG	dark beige	20	0117920000
AP SAKR BL	blue	20	0211380000	AP SAK4-10 I	beige	20	0117910000
AP ASK1.5	beige	50	0340560000	AP ASK1 DB	dark beige	20	1753320000
AP SAK70/35	beige	10	0340960000	AP 100 GR	grey	20	1773410000
AP AST1+5 DB	dark beige	20	0266400000	AP DLI2.5 DB	dark beige	20	1783550000
AP ASK1	beige	20	0380360000	AP DLD2.5/PE DB	dark beige	20	1783800000
AP SAK16 BL	blue	20	0271180000	AP VLI1.5 DB	dark beige	20	1784150000
AP DK4	beige	20	0359260000	AP VLI1.5/PE DB	dark beige	20	1784160000
AP SAK2.5 GE	yellow	20	0279500000	AP DLD2.5 DB	dark beige	20	1784210000
AP SAK2.5 OR	orange	20	0279540000	AP 110 GR	grey	10	1790080000
AP SAK2.5L KRG BL	blue	20	0279570000	AP SAKR BE RS-SET	beige	5	1820200000
AP SAK2.5 BL	blue	20	0279580000	AP SAK4-10 GR 7042	grey	20	1853970000
AP AKZ4 BL	blue	20	0294480000	AP 2 DSG1.5T	beige	1	2119490000
AP SAK95 KRG	blue	10	0550920000	AP PPT/35	black	10	3835120000
AP DSK1.5	beige	20	0532960000	AP RV	beige	1	4145220000
AP SAK35 KRG/BL	blue	10	0303670000	AP OSC 10/16	beige	10	9154850000
AP DK4S	beige	20	0631360000	AP OSC 4	beige	10	9154860000
AP SAK35/TW SAK16 BL	blue	10	0303680000	AP STA2.5 0.5MM	beige	1	2012770000
AP SAK2.5L KRG BL	blue	20	0309270000	AP KDKS1 1.5	beige	20	9503330000
AP ADK1	beige	50	0476260000	AP KDKS1 EN	beige	20	9503340000
AP AKZ1.5 BL	blue	50	0340580000	AP KSKM	beige	20	9509630000
AP SAK2.5/35 + AST3+4	beige	20	0460560000	AP SAK4-10 GE	yellow	1	2076890000
AP TOP4SF-FF	beige	20	0483460000	AP SAK16 GE	yellow	1	2076900000
AP DK4 BL	blue	20	0359280000	AP SAK35/TW SAK16 GE	yellow	1	2076910000
AP ASK1 RT	red	20	0380350000	AP AST3+4/35 GE	yellow	1	2077060000
AP ASK1 BL	blue	20	0380380000	AP AKZ4 GE	yellow	50	2077070000
AP DLD2.5/PE	beige	20	1595960000	AP SAK2.5/35	beige	1	2144900000
AP VLI1.5/PE	beige	20	1633320000	AP ATA1	beige	1	2093550000
AP VLI1.5	beige	20	1633260000	AP SAK4 KRG M.FU	dark beige	20	0460020000
AP MAK2.5	beige	20	1615280000	AP DK4/380 Q	beige	20	0438560000
AP DK4Q	beige	20	1397160000	AP SAKB/C/T BE	beige	1	4140450000
AP DLI2.5	beige	20	1313260000	AP SAKB/C/T1 DB	dark beige	1	4173520000
AP DLD2.5	beige	20	1317660000	AP MAK2.5 DB	dark beige	20	7917000000
AP ST5 PPO/SW	black	10	0447240000	AP SAKK4/10 KER/WS	white	10	9502630000
AP ST5 PA/BE	beige	10	0447260000	AP KDKS1 1.5 DB	dark beige	20	9532470000
AP SAK2.5/35 DB	dark beige	20	0460490000				
AP TW/SS.../35	beige	10	1333200000				
AP SAK2.5/35 BL	blue	20	0460580000				
AP SAKS1+3 KRG	dark beige	20	0191320000				
AP SAKD2.5N	beige	20	0150960000				
AP SAKR KRG	dark beige	20	0211320000				
AP TAL	beige	20	0212260000				
AP SAKA KRG	dark beige	20	0134220000				
AP SAK95 KRG/BL	blue	10	0550970000				
AP SAKH6-10 KRG	dark beige	20	0131720000				
AP SAKB/C/T KRG	dark beige	20	0146720000				
AP AKA2.5	beige	100	0162520000				
AP DK4Q DB	dark beige	20	0631300000				
AP DK4S BL	blue	20	0631380000				
AP AKZ4	blue	20	0294460000				
AP AKZ4 KRG	dark beige	20	0294420000				
AP SAK35/TW SAK16	beige	10	0303660000				

Colour coding options



The colours listed here are available as standard. Other types of terminals in custom colours can be supplied on request, provided a minimum quantity is ordered.

Type	Colour	Qty.	Order No.
SAK 2.5 AL BLUE (E)	blue	100	6253140000
SAK 2.5 BL	blue	100	0279680000
SAK 2.5 BL RS-SET	blue	10	1817860000
SAK 2.5 KRG/BL	blue	100	0279670000
SAK 2.5 OR	orange	100	1326360000
SAK 2.5 SW 1X1	black	100	0108560000
SAK 2.5 SW 1X1/KRG	black	100	0108520000
SAK 2.5/35 BL	blue	100	0380480000
SAK 2.5/35 DBL	blue	100	1799920000
SAK 2.5/35 GE	yellow	100	1821480000
SAK 2.5/35 KRG/BL	blue	100	0380470000
SAK 2.5/35 OR	orange	100	0380440000
SAK 2.5/35 RT	red	100	1799910000
SAK 2.5/35 SW	black	100	1799900000
SAK 2.5/35 SW 1X1	black	100	0514060000
SAK 2.5/EN BL	blue	100	0218680000
SAK 2.5/EN BR	brown	100	1858450000
SAK 2.5/EN SW	black	100	1858440000
SAK 2.5/EN WS	white	100	1858460000
SAK 2.5/TC AL BL	blue	100	0107180000
SAK 2.5/TC CH BL	blue	100	0107280000
SAK 35/35 BL	blue	20	0380780000
SAK 35/EN BL	blue	20	1784400000
SAK 4 BL	blue	100	0128380000
SAK 4 BL RS-SET	blue	10	1817780000
SAK 4 EP/SW	black	100	0128300000
SAK 4 KRG BL	blue	100	0128370000
SAK 4 OR	orange	100	0105060000
SAK 4 SS/35 6.3 GR	grey	100	0646930000
SAK 4/35 BL	blue	100	0443680000
SAK 4/35 KRG/BL	blue	100	0443670000
SAK 4/35 OR	orange	100	1323660000
SAK 4/35/AP GG	green/yellow	100	0443650000
SAK 4/EN BL	blue	100	0467480000
SAK 4/EN BR	brown	100	9130990000
SAK 4/EN GE	yellow	100	9129930000
SAK 4/EN GN	green	100	9129950000
SAK 4/EN GR	grey	100	9129960000
SAK 4/EN GR 7042	grey	100	1853950000
SAK 4/EN OR	orange	100	0467400000
SAK 4/EN RT	red	100	9129920000
SAK 4/EN SW	black	100	9130980000
SAK 4/EN WS	white	100	1773340000
SAK 6/35 BL	blue	100	0380580000
SAK 6/35 GN/GE	yellow	100	1866850000
SAK 6/35 KRG/BL	blue	100	0380570000
SAK 6/EN BL	blue	100	0212880000
SAK 6/EN GE	yellow	100	1772820000
SAK 6/EN OR	orange	100	1772810000
SAK 6/EN RT	red	100	0212840000
SAK 6/EN SW	black	100	0212810000
SAK 6/EN WS	white	100	1773350000
SAK 6N BL	blue	100	0193280000
SAK 10 BL	blue	100	0110080000
SAK 10 KRG/BL	blue	100	0110070000
SAK 10 OR	orange	100	0110040000
SAK 10/35 BL	blue	100	0443780000
SAK 10/35 KRG/BL	blue	100	0443770000
SAK 10/EN BL	blue	100	1784410000
SAK 10/EN GR RAL 7042	grey	100	1853960000
SAK 10/EN OR	orange	100	1772830000
SAK 10/EN SW	black	100	1773900000
SAK 16 BL	blue	50	0271080000
SAK 16/35 BL	blue	50	0380680000
SAK 16/EN BL	blue	50	1784390000
SAK 70 KRG/BL	blue	10	0340870000
SAK 95/35 KRG/BL	blue	10	0662270000
SAKC 4/2STB7 BL	blue	100	0340670000
SAKD 2.5/35 BL	blue	100	0268880000
SAKD 2.5N BL	blue	100	0215580000
SAKH 6 EP/SW	black	50	0126600000

Type	Colour	Qty.	Order No.
SAKH 10 EP/SW	black	50	0126700000
SAKH 35 EP/SW	black	20	1596240000
SAKR 2STB BL	blue	100	0412280000
SAKR BL	blue	100	0412180000
SAKR OR	orange	100	1461960000
SAKR/35 2STB BL	blue	100	0183380000
SAKR/35 BL	blue	100	0172180000
SAKR/35 WS	white	100	0172190000

Cross-connection systems

Cross-connections across more than 10 modular terminals

The SAKD 2.5 N, SAK 2.5, SAK 4 and SAK 6 N terminals include the option of setting up a cross-connection with more than 10 poles, e.g. 20-pole:

2 No. Q 10 + 1 No. QL 2.

The end fixing screws are removed from the Q 10 links by unscrewing them from the VH sleeves. The QL 2 is positioned between these and the two fixing screws screwed into their VH sleeves again. This arrangement allows 20 poles to be crossconnected.

Q pre-assembled cross-connectors

The pre-assembled cross-connector has the appropriate number of cross-connection links, cross-connection sleeves and fixing screws to match the number of poles required already installed in a captive arrangement. Such pre-assembled cross-connectors merely have to be inserted into the appropriate terminals during installation. These crossconnectors can be supplied in 2-, 3-, 4- and 10-pole versions.

QL cross-connection links

Cross-connection links are used to provide cross-connections with equal potential across several modular terminals. The cross-connection links are made from copper or brass with an electroplated tin coating, and can be supplied in lengths to suit 2, 3, 4 and 10 poles, to match the respective terminal width. The electrical connection between the cross-connection link and the busbar of the modular terminal is by way of a connecting sleeve.

BS fixing screws

A steel fixing screw is used to connect the cross-connection link to the connecting sleeve on the busbar under a modular terminal. It is the purpose of the steel screw to provide a secure mechanical fixing between the cross-connection and the busbar. Two types of screw are used: form A has a full-length thread, and form B has a plain shaft below the head with a captive washer.

VH connecting sleeves

The length of the connecting sleeve is matched to the size of the terminal. The sleeves are made from tin-coated copper or brass. One connecting sleeve must be used for every terminal to be cross-connected.

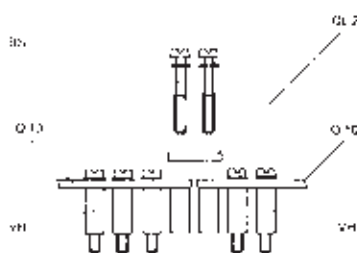
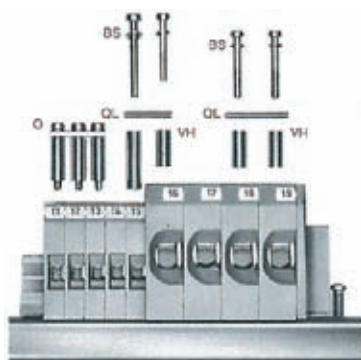

Cross-connection systems

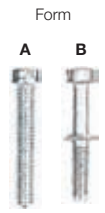
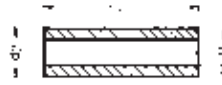
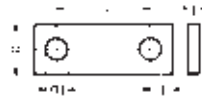

		Q		QL					VH					BS					
		Pre-assembled cross-connection		Cross-connection links					Continuous current rating of cross-connection					Fixing screws					
Type	Rated current of modular terminals	Type Poles	Order No.	Type Poles	Order No.	Dimensions					Type Length	Order No.	L	d2	d1	Size			
						b	t	L	d1	l						Order No.	Form	M	
SAK 2.5	24 A	Q 2	0370000000	QL 2	0155900000	6	0.6	6	3.4	2.4	32 A	VH 8	0266700000	8	4.9	3.2	0359000000	B	3 x15
		Q 3	3710000000	QL 3	0156000000						32 A								
		Q 4	3720000000	QL 4	0156100000						32 A								
		Q 10	0368700000	QL 10	0338100000						32 A								
SAK 4	32 A	Q 2	0336700000	QL 2	0130600000	6	0.6	6.5	3.4	2.5	41 A	VH 13.5	0248500000	13.5	5	3.2	0303000000	B	3x20
		Q 3	0336800000	QL 3	0130700000						41 A								
		Q 4	0336900000	QL 4	0130800000						41 A								
		Q 10	0368800000	QL 10	0338200000						36 A								
SAK 6 N	41 A	Q 2	0456700000	QL 2	0194300000	6	1	8	3.4	3	41 A	VH 12	0249000000	12	5	3.2	0303000000	B	3x20
		Q 3	0456800000	QL 3	0194400000						41 A								
		Q 4	0456900000	QL 4	0194500000						41 A								
		Q 10	0457000000	QL 10	0338300000						41 A								
SAK 10	57 A	Q 2	0457100000	QL 2	0470300000	6	2	10	3.4	3.5	57 A	VH 12	0249000000	12	5	3.2	0303000000	B	3x20
		Q 3	0457200000	QL 3	0470400000						57 A								
		Q 4	0457300000	QL 4	0470500000						57 A								
		Q 10	0457400000	QL 10	0470600000						57 A								
SAK 16	76 A	Q 2	0457500000	QL 2	0470700000	6	2	12	3.4	4	76 A	VH 12	0249000000	12	5	3.2	0303000000	B	3x20
		Q 3	0457600000	QL 3	0470800000						76 A								
		Q 4	0457700000	QL 4	0470900000						76 A								
		Q 10	0457800000	QL 10	0471000000						76 A								
SAK 35 N	125 A			QL 2	0564900000	8	3	16	4.5	5	99 A	VH 17	0267000000	17	8	5	0267100000	A	4x30
				QL 3	0565000000						99 A								
				QL 4	0565100000						99 A								
				QL 10	0565200000						99 A								
SAK 35	125 A			QL 2	0123600000	8	3	18	4.5	5	99 A	VH 17	0267000000	17	8	5	0267100000	A	4x30
				QL 3	0123700000						99 A								
				QL 4	0123800000						99 A								
				QL 10	0338600000						99 A								
SAK 70	192 A			QL 2	0345300000	14	4	22	5.5	7	180 A	VH 30.5	0345500000	30.5	11	5.5	0345600000	A	5x45
				QL 3	0167000000						180 A								
SAK 95	232 A			QL 2	0551200000	14	4	28	6	7	180 A	VH 35	0551100000	35	11	5.5	0630200000	B	5x50
				QL 3	0407600000						180 A								
				QL 4	0407700000						180 A								
SAKS 1	6,3 A			QL 2	0191400000	6	2	12.9	3.4	3	47 A						0346200000	B	3 x 6
SAKS 3	10 A			QL 3	0191500000						47 A								
SAKS 6	10 A			QL 4	0191600000						47 A								
SAKS 7	10 A			QL 10	0338800000						36 A								
SAKS 4	16 A			QL 2	0328000000	10	4	24	4.8	5	47 A						0199700000	A	3 x 7
				QL 3	0328100000						47 A						0103300000	A	4 x 9
				QL 4	0328200000						47 A								
				QL 10	0339000000						36 A								
SAKS 2	10 A			QL 2	0207800000	10	4	27.6	4.8	6.5	47 A						0103300000	A	4 x 9
SAKS 5	63 A			QL 3	0207900000						47 A								
				QL 4	0208000000						47 A								
				QL 10	0338900000						36 A								
DK 4 Q	41 A	Q 2	0336400000	QL 2	0297200000	4	0.8	6.1	2.8	2.5	32 A	VH 5	0296800000	5	4	2.7	0400100000	B	2.5x11
DKB 4 Q/10	41 A	Q 3	0336500000	QL 3	0297300000						32 A								

Cross-connection systems

Cross-connections between terminals of different sizes to increase the cross-section

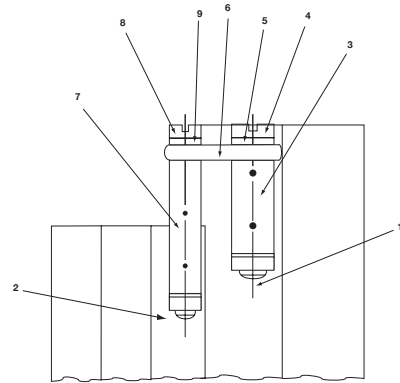
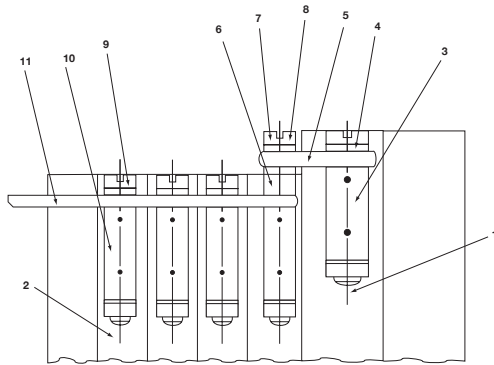

Terminal	Position	Type	Order No.	Current
from SAK 16	1	-	-	-
sleeve	3	VH 12	0249000000	-
screw	4	BS M 3 x 20	0303000000	-
to SAK 6 N	2	-	-	-
cross-connection link	5	QL 2	0470300000	-
sleeve	6	VH 4,5	0303200000	-
screw	7	BS M 3 x 25	0292500000	-
washer	8	SS M 3	0164400000	-
screw	9	BS M 3 x 20	0303000000	-
sleeve	10	VH 12	0249000000	-
cross-connection link	11	QL 2	0194300000	47 A
cross-connection link	11	QL 3	0194400000	47 A
cross-connection link	11	QL 4	0194500000	47 A
cross-connection link	11	QL 10	0338300000	36 A
to SAK 2.5	2	-	-	-
cross-connection link	5	QL 2	0470300000	-
sleeve	6	VH 12	0249000000	-
screw	7	BS M 3 x 30	0296200000	-
retaining screw	8	SS M 3	0164400000	-
screw	9	BS M 3 x 15	0359000000	-
sleeve	3	VH 12.5	0308000000	-
sleeve	3	VH 8	0266700000	-
cross-connection link	11	QL 2	0155900000	27 A
cross-connection link	11	QL 3	0156000000	27 A
cross-connection link	11	QL 4	0156100000	27 A
cross-connection link	11	QL 10	0338100000	27 A
from SAK 10	1	-	-	-
screw	4	BS M 3 x 20	0303000000	-
to SAK 4	2	-	-	-
sleeve	3	VH 13.5	0248500000	-
cross-connection link	5	QL 2	1443000000	-
screw	7	BS M 3 x 20	0303000000	-
screw	9	BS M 3 x 20	0303000000	-
sleeve	10	VH 13.5	0248500000	-
cross-connection link	11	QL 2	0130600000	36 A
cross-connection link	11	QL 3	0130070000	36 A
cross-connection link	11	QL 4	0130800000	36 A
cross-connection link	11	QL 10	0338200000	36 A
to SAK 2.5	2	-	-	-
cross-connection link	5	QL 2	0193400000	36 A
sleeve	1	VH 13	0304000000	-
screw	4 + 7	BS M 3 x 20	0303000000	-
screw	9	BS M 3 x 15	0359000000	-
sleeve	10	VH 8	0266700000	-
cross-connection link	11	QL 2	0155900000	27 A
cross-connection link	11	QL 3	0156000000	27 A
cross-connection link	11	QL 4	0156100000	27 A
cross-connection link	11	QL 10	0338100000	27 A
sleeve	3	VH 13	0304000000	-
sleeve	3	VH 6.5	0286400000	-

Terminal	Position	Type	Order No.	Current
von SAK 35	1	-	-	-
sleeve	3	VH 17	0267000000	-
screw	4	BS M 4 x 30	0267100000	-
washer	5	SS M 4	0136400000	-
zu SAK 10 N	2	-	-	-
cross-connection link	5	QL 2	0207400000	47 A
sleeve	6	VH 4,5	0303200000	-
screw	8	BS M 3 x 35	0309800000	-
washer	9	SS M 3	0164400000	-
zu SAK 6 N	2	-	-	-
cross-connection link	6	QL 2	0207400000	47 A
sleeve	7	VH 27	0309400000	-
screw	8	BS M 3 x 35	0309800000	-
retaining screw	9	SS M 3	0164400000	-
von SAK 35 N	1	-	-	-
sleeve	3	VH 17	0267000000	-
screw	4	BS M 4 x 30	0267100000	-
retaining screw	5	SS M 4	0136400000	-
zu SAK 10	2	-	-	-
cross-connection link	6	QL 2	0207400000	47 A
sleeve	7	VH 27	0309400000	-
screw	8	BS M 3 x 35	0309800000	-
retaining screw	9	SS M 3	0164400000	-
zu SAK 6 N	2	-	-	-
cross-connection link	6	QL 2	0135500000	47 A
sleeve	7	VH 27	0309400000	-
screw	8	BS M 3 x 35	0309800000	-
retaining screw	9	SS M 3	0164400000	-
von SAK 10	1	-	-	-
sleeve	3	VH 12.5	0300800000	-
screw	4	BS M 3 x 20	0303000000	-
retaining screw	5	SS M 3	included	-
zu SAK 35 N	1	-	-	-
sleeve	3	VH 13	0304000000	-
screw	4	BS M 3 x 20	0303000000	-
washer	5	SS M 3	included	-
zu SAK 2.5	2	-	-	-
cross-connection link	6	QL 2	0130600000	27 A
sleeve	7	VH 16	0309700000	-
screw	8	BS M 3 x 20	0303000000	-
retaining screw	9	SS M 3	included	-

Screw-in cross-connectors (Q)

In this type of cross-connection the cross-connection link, connecting sleeves and fixing screws are pre-assembled in a captive arrangement. However, all the individual parts are also available separately on request. During installation, these pre-assembled cross-connectors are simply inserted into the cross-connection slot in the middle of the terminal and screwed tight. Any number of poles can be achieved by linking two cross-connections. For example, a 20-pole cross-connection by joining together two 10-pole cross-connections with the cross-connection link of a 2-pole cross-connection (see figure below)..

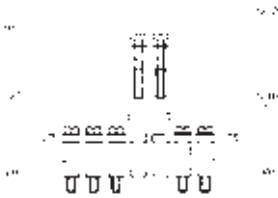

Q ... AKZ 4SS



Technical specification	
continuous current, 2-pole/multi-pole	A
thread size	M 2.5
tightening torque	Nm

Ordering data	
2-pole	Q...2 AKZ 4SS
3-pole	Q...3 AKZ 4SS
4-pole	Q...4 AKZ 4SS
10-pole	Q...10 AKZ 4SS
24-pole	

32 / 32	
M 2.5	
0.4 ... 0.6	

Type	Qty.	Order No.
Q...2 AKZ 4SS	50	0369000000
Q...3 AKZ 4SS	50	0369100000
Q...4 AKZ 4SS	50	0369200000
Q...10 AKZ 4SS	20	0369300000

for terminal
AKZ 4SS

Q ... DLI 2.5



24 / 24	
M 2.5	
0.4 ... 0.6	

Type	Qty.	Order No.
Q...2 DLI 2..5	50	1312500000
Q...3 DLI 2..5	50	1312600000
Q...4 DLI 2.5	50	1312700000
Q...10 DLI 2.5	20	1313100000

for terminal
DLI 2.5
DLA 2.5
DLD 2.5

Q ... AKZ 1.5



Technical specification	
continuous current, 2-pole/multi-pole	A
thread size	M 2.5
tightening torque	Nm

Ordering data	
2-pole	Q...2 AKZ 1.5
3-pole	Q...3 AKZ 1.5
4-pole	Q...4 AKZ 1.5
10-pole	Q...10 AKZ 1.5
24-pole	

24 / 24	
M 2.5	
0.4 ... 0.6	

Type	Qty.	Order No.
Q...2 AKZ 1.5	50	0368200000
Q...3 AKZ 1.5	50	0368300000
Q...4 AKZ 1.5	50	0368400000
Q...10 AKZ 1.5	20	0368500000

for terminal
AKZ 1.5
AKZ 2.5

Q ... AKZ 4



32 / 32	
M 2.5	
0.4 ... 0.6	

Type	Qty.	Order No.
Q...2 AKZ 4	50	0336400000
Q...3 AKZ 4	50	0336500000
Q...4 AKZ 4	50	0336600000
Q...10 AKZ 4	20	0338600000

for terminal
AKZ 4

Potential distribution

Removable cross-connection links

Removable cross-connection links are intended for 2-pole, easily disconnected cross-connections. They are fitted together with a VH connecting sleeve and a BS fixing screw.



VL 2

Removable cross-connection links



for terminal
SAK 4
SAK 6 N
SAK 10
SAK 16
SAK 35

Type	Qty.	Order No.
VL 2	50	019700000
VL 2	50	019470000
VL 2	50	013590000
VL 2	50	013580000
VL 2	50	012400000

VH

Connecting sleeves



Type	Qty.	Order No.
VH 19	50	028510000
VH 19	50	028510000
VH 19	50	028510000
VH 24,5	50	029870000

BS

Fixing screws



Type	Qty.	Order No.
BS M3x25	100	029250000
BS M3x25	100	029250000
BS M3x25	100	029250000
BS M4x35	50	029890000

Spacer pillars

The DS spacer pillars are made from a tempered insulating material and are used so that individual current paths can be disconnected by removing the fixing screw. The current in the cross-connection is fed via the fixing screw in this arrangement. Therefore, we prescribe the use of screws made from CuNi 60 (a copper-nickel alloy). The use of an end bracket with a screw holder avoids losing fixing screws that have been removed.

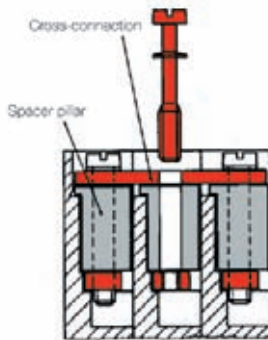

Spacer pillars type DS



for terminal
SAK 2.5
SAK 4
SAK 6 N
SAK 10 and SAK 16

Type	Qty.	Order No.
DS 9*	100	033093000
BS M 3x15 CuNi	100	037720000
DS 14*	100	020753000
BS M 3x20 CuNi	100	037710000
DS 12,5*	100	020773000
BS M 3x20 CuNi	100	037710000
DS 12,5*	100	020763000
BS M 3x20 CuNi	100	037710000

* Height in mm

EW 35

End bracket for TS 35 with screw holder for fixing screws that have been removed.



Type	Qty.	Order No.
EW35/TS 35 with screw holder	20	025866000

EWK 2

End bracket for TS 32 with screw holder for fixing screws that have been removed.



Type	Qty.	Order No.
EWK 2/TS 32 with screw holder	20	025876000

Rail holder

For an insulated terminal rail arrangement in fully insulated installations.

SH 2



for terminal
EK 2.5 N, EK 2.5/35, EK 4, EK 4/35, EK 6/35, EK 10, EK 10/35, EK 16, EK 16/35, EK 35, EK 35/35

Type	Qty.	Order No.
SH2	10	049492000

Testing/Checking

Test plugs/Sockets

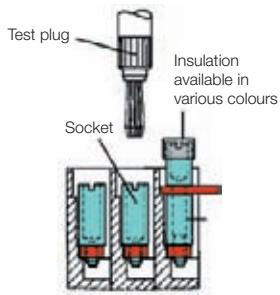

Test plugs (PS) are used for measurement purposes or for the final checking of a finished terminal strip installation. Test plugs for sockets are available with 2.3 and 4 mm I.D. The difference between these and a test adapter is that the test plug does not automatically clip into the terminal. This means that a secure connection to modular feed-through terminals up to 35 mm² is only possible in conjunction with a socket.

The **sockets (StB)** enable the PS test plug and the QS plug-in cross-connectors to be plugged in. The sockets are screwed into the busbar in the cross-connection slot in the middle of the terminal or screwed into the modular terminal instead of the clamping screw.

If a cross-connection has to provide a test option as well, then an StB 28.5 or 30.5, which has an insulating sleeve and can accommodate the PS 4 test plug, is screwed in instead of the fixing screw.

PS



Type	Qty.	Order No.
2.3 mm dia./rated current 17.5 A PS 2.3	20	0180400000
4.0 mm dia./rated current 24 A PS 4	20	0299600000

PS 2 / PS 2 MC



Type	Qty.	Order No.
PS 2 for 2 mm dia. sockets for soldered conductor cross-section 1.5 mm ²	20	0293800000
PS 2 MC for soldered conductor cross-section 0.75 mm ² , can also be plugged directly into threaded hole in busbar for terminal types AKZ 4, AKB 4, AKZ 2.5, AKZ 1.5	20	0310000000

ZS 2.3/4



Type	Qty.	Order No.
ZS 2.3/4 Adapter plug for connecting sockets with 2.3 and 4 mm I.D. Can also be plugged directly into threaded hole in busbar for terminal types SAK 2.5 and SAK 4.	20	0249600000

FZS 2/4 / FK 4



Type	Qty.	Order No.
FZS 2/4 Flexible adapter plug for connecting sockets with 2.3 and 4 mm I.D.	20	1276300000
FK 4 Flexible coupling for connecting test plug to test adapter. The unconnected end of the conductor is protected against fraying by a wire end ferrule.	20	1678650000

TA 1



Type	Qty.	Order No.
TA 1 The conductor is soldered on, or crimped on with the HTG 58 crimping pliers.	20	0535860000
HTG 58 conductor: max. 0.75 mm ² remove shoulder stripping length: 14 mm	1	9012000000

The SAKR modular disconnect terminals are available already fitted with sockets (see "Modular disconnect terminals"). These sockets are provided with a slot for actuating with a screwdriver. Weidmüller can supply special screwdrivers with a shoulder for this purpose (chapter J).

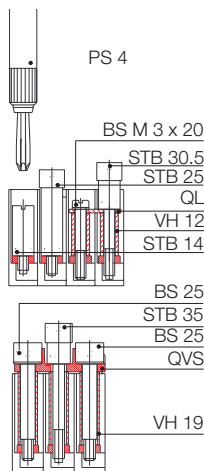

StB for SAKT

The type StB 25 socket accepts test plug PS 4 in type SAKT 1 and SAKT 2 disconnect terminals, or the QS plug-in cross connector.

The type StB 35 socket is used when simultaneous testing is necessary with a QVS cross-connection slider.

Complete with insulating sleeve to prevent contact with live parts and colour-coded test plug and plug-in cross-connection, 4 mm dia.

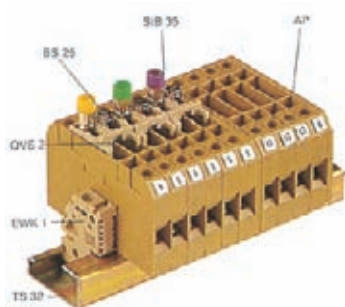

StB 5.5...17



Type	for terminal type	L1	L2	d1	d2	M	Qty.	Order No.
StB 5.5	SAKL 4/20 1)	5,5	11	2,3	3,7	3	100	0122700000
StB 6	AKZ 4, DK 4, SAKR 1)	6	11,5	2,3	3,9	3	100	0379400000
StB 6	SAK 2.5 1)	6	13	2,3	3,9	2,5	50	0130200000
StB 7	SAK4, SAK4 1)	7	14,5	2,3	4	3	100	0358500000
StB 7.5	SAK 10, SAKB 10 1)	7,5	17	4	6	4	50	0130000000
StB 8.5	AKZ 4 / DK 4/ SAKD 2.5 N	8,5	11,5	2,3	4	2,5	50	0215700000
StB 8.5	SAK 2.5	8,5	12	2,3	5	3	50	0280600000
StB 8.5	SAKT 4	8,5	12	2	4,5	3	50	0244600000
StB 13.5	SAKA 10 / SAKC 10	13,5	18,5	4	6	4	50	0135200000
StB 14	SAK 4	14	17,5	2,3	5	3	50	0168600000
StB 14	SAK6N, 10, 16 / SAKT 1, SAKT 2	14	19	4	6	3	50	0169900000
StB 16	SAK70, SAK 95	16	28	4	7	5	50	0385400000
StB 16	SAK 35, SAKB 10	16	23	4	7	4	50	0140200000
StB 17	SAKC 10	17	22	4	6	4	50	0147100000

StB 28.5 / 30.5

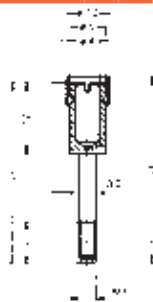

Type	Colour	terminal type	L1	L2	L	Qty.	Order No.
StB 30.5	black	SAK 4, SAK 6 N	30.5	31.7	7	50	0341000000
StB 30.5	grey	SAK 10, SAK 16	-	-	-	50	0341100000
StB 30.5	blue	-	-	-	-	50	0341200000
StB 30.5	red	-	-	-	-	50	0341300000
StB 30.5	green	-	-	-	-	50	0341400000
StB 30.5	yellow	-	-	-	-	50	0341500000
StB 30.5	violet	-	-	-	-	50	0341600000
StB 28.5	black	SAK 2.5	28.5	29.7	9	50	0133400000

StB 25



Type	Colour	for terminal type	Qty.	Order No.
StB 25	yellow	SAKT 1 and SAKT 2	50	0267200000
	green		50	0271200000
	violet		50	0271300000
	black		50	0271500000
	grey		50	0271400000
	blue		50	0343400000
	red		50	0343300000

StB 35

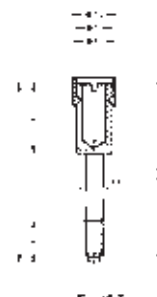

Type	Colour	for terminal type	Qty.	Order No.
StB 35	yellow	SAKT 1 and SAKT 2	50	0389000000
	green		50	0388900000
	violet		50	0389100000
	black		50	0388500000
	grey		50	0388600000
	blue		50	0388700000
	red		50	0388800000

¹⁾ used instead of the clamping screw

Protective covers

Protective covers

Several safety regulations, e.g. the German accident prevention code covering electrical systems and equipment (VBG 4) or the standard VDE 0106 part 100 (March 1983), call for live parts of electrical systems to be protected against direct contact by any part of the body.

In the case of modular terminals this protection must always be provided in the form of additional covers when cross-connectors or test sockets are fitted. Therefore, Weidmüller can supply cover strips with associated retaining plates which can be used with the more common sizes of terminal. The retaining plates can be fitted at the ends or within the terminal strip, and can be fitted to TS 32, TS 35 or TS 15 terminal rails.

Spacing of retaining plates:

The length of the ADP 1, 2 and 3 between retaining plates should not exceed about 500 mm. The cover strip is clipped into tabs on the side. Additional security is provided by a spigot on the retaining plate, which can also be sealed with lead. On terminal type SAK 95 the ADP 3 cover strip can be clipped directly onto the terminal. Transparent cover strips enable the terminals with their accessories and labelling to remain visible at all times. Additional labelling, e.g. for groups, can be added.

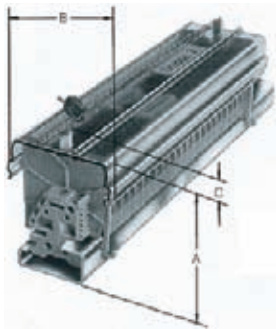

ADP

Cover strips

Unplasticised PVC, supplied in 1 m pieces, max. temperature 70°C



transparent	
Type	Order No.
ADP 1	0485200000
ADP 2	0485300000
ADP 3	0485400000
grey	
Type	Order No.
ADP 4 (1000 mm)	1430760000
ADP 4 (300 mm)	1378160000
TSK 31.5	0347960000

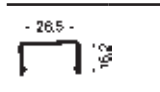
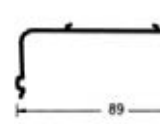
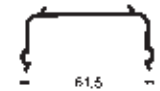
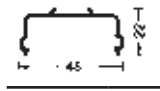

HP

Retaining plates

PA 66, 2 mm thick



For fitting to TS 35 and TS 32, with spigot for lead seal	
Type	Order No.
HP 1	0485560000
HP 2	0485660000
HP 3	0485760000
HP 4	0485860000
For fitting to TS 15	
Type	Order No.
HP 7	0258260000
HP 8	0258360000

Spigot for lead seal

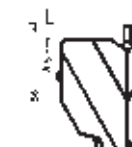

Overall dimensions	A	A	A	A	B	C
for mounting on terminal rail	TS 32	TS 35 x 7.5	TS 35 x 15	TS 15		
ADP 1, HP 1	61	56	63		49	6
ADP 2, HP 2	77	72	79		62.5	6
ADP 3, HP 3	94	89	86		92	6
ADP 3, HP 4	73.5	68.5	75.5		92	6
ADP 1, HP 8				45	49	6
TSK 31.5, HP 7				35	31	6
Labelling material					Qty.	Order No.
"Lightning flash" symbol, self-adhesive, 20 labels per card					5	0566700000

* only for PA 66 versions

Allocation to some terminal types	ADP cover strips			HP retaining plates		
	Type	Qty.	Order No.	Type	Qty.	Order No.
SAKD 2.5 N, EK 2.5 N, SAK 2.5, SAK 2.5/35	ADP 1	36	0485200000	HP 1	20	0485560000
SAK 4, EK 4, SAK 4/35, EK 2.5/35, EK 4/35	ADP 2	36	0485300000	HP 2	20	0485660000
SAK 6 N, EK 10, SAK 10, EK 6/35, SAK 6/35, EK 10/35						
SAKR, SAKR-D, DK 4						
SAK 16, EK 16, EK 35, SAK 35, SAKC 4, SAK 16/35	ADP 3	20	0485400000	HP 3	20	0485760000
SAKC 10, SAK 70, SAKS 1, SAKS 2, Sak 35/35, SAK 70/35						
SAKS 3, SAKS 4, SAKS 5						
SAK 95	ADP 3	1	0485400000	not applicable		
ASK 1, SAKA 10, SAKT 1, SAKB 10, SAKT 2,	ADP 3	1	0485400000	HP 4	20	0485860000
AST*, SAK 2.5, SAK 4	ADP 4	1	1430760000	not applicable		
	ADP 1	1	0485200000	HP 8	20	0258360000
				not applicable		
1000 mm long			1	1430760000		
300 mm long			10	1378160000		
	ADP 4	10	1378160000			
	TSK 31.5	1	0347960000	HP 7	20	0258260000

Several German VDE standards, e.g. VDE 0106 part 100 (March 1983), specify that mains terminals must be covered. Weidmüller can supply a range of such covers printed with a warning "lightning flash" and the international warning symbol. The other side features a "lightning flash" symbol with the warning "Danger! Electricity". Plastic screws are used to fix the cover plates to the terminal strips. The cover plates are intended for 3- or 4-pole terminals. Type BSK plastic screws are used to fix the plates. BSK = PA 66

AD/WAD covers



AD 3 (3-pole)

Terminal type	Terminal width (mm)	Qty.	Order No.	Screw	Qty.	Order No.
SAK 2.5	6	50	0297900000	M 3 x 22	100	0128900000
AKZ 4	6	50	0297900000	M 2.5 x 18	100	0303300000
DK 4 Q	6	50	0297900000	M 2.5 x 18	100	0303300000
SAK 4	6.5	50	0297600000	M 3 x 22	100	0128900000
SAK 6 N	8	50	0297700000	M 3 x 22	100	0128900000
SAK 10	10	50	0178500000	M 3 x 22	100	0128900000
SAK 16	12	50	0297800000	M 3 x 22	100	0128900000
SAK 35 N	18	50	0273400000	M 4 x 32	100	0129100000
SAK 70	22	10	0344300000	M 5 x 45	50	0344400000
Screw for lead seal				M 3 x 20	100	0451300000

AD 3 (4-pole)

SAK 2.5	6	50	0303400000	M 3 x 22	100	0128900000
AKZ 4	6	50	0303400000	M 2.5 x 18	100	0303300000
DK 4 Q	6	50	0303400000	M 2.5 x 18	100	0303300000
SAK 4	6.5	50	0285300000	M 3 x 22	100	0128900000
SAK 6 N	8	50	0196600000	M 3 x 22	100	0128900000
SAK 10	10	50	0178600000	M 3 x 22	100	0128900000
SAK 16	12	50	0518200000	M 3 x 22	100	0128900000
SAK 35	18	50	0178700000	M 4 x 32	100	0129100000
SAK 35 N	16	50	0576700000	M 4 x 32	100	0129100000
Screw for lead seal				M 3 x 20	100	0451300000

TBS 2 / BST 2

for the SAK series

Protective covers

Details

- For covering uninsulated cross-connections on SAK 2.5...SAK 16 terminals.
- Identification of functional groups.
- Easily fitted by inserting the insulating plate into the existing insulating plate slot in the terminal.
- Labelling strips are clipped into the insulating plates.
- Labelling of stable labelling strip with felt-tip pen for permanent labelling or pencil for temporary labelling.



Type	Order No.
Type	
TBS 2, polyamide	
BST 2, unplasticised PVC	
Ordering data	
Type	
TBS insulating plate	1287860000
BST 2 labelling strip (300 mm long)	1287700000

AD

for SAKG

Cover plates

These can be assembled either with two end clamp plates or with one end clamp plate and one partition plate plus mounting bracket.

Cover plates with self-adhesive label

Dimensions of cover plates

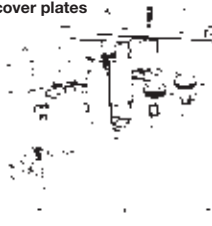

2 mm thick

Type	Type	a	b	c	Order No.
for SAKG 28	AD 3	89	120	74	-
for SAKG 28	AD 4	116	120	102	0263100000
for SAKG 32 and 70	AD 4	132	120	118	0283100000
for SAKG 40	AD 3	124	160	110	-
for SAKG 40	AD 4	164	160	150	0263200000
for SAKG 46	AD 4	188	160	174	0263300000
for SAKG 54	AD 3	166	160	152	0264900000
for SAKG 54	AD 4	220	160	206	0261100000

AH

for SAKG

Shrouding covers

For open-type terminals like type SAKG. Shrouding covers are used – instead of other cover types – to provide the necessary protection against contact (required by German standard VBG 4). Shrouding covers are simply placed over the terminals.



Type	a	b	c	d	Order No.	
dimensions in mm						
for SAKG 28	AH 28	156	26	74	94	0326660000
for SAKG 32/70	AH 32	156	30	74	94	0326760000
for SAKG 40	AH 40	186	38	78	94	0326860000
for SAKG 46	AH 46	196	46	78	94	0326960000

Protective covers

Cover strips for terminal strips

To protect against contact, dust and moisture, Weidmüller can supply cover strips which, for example, are useful in signal or lighting mast distribution boards.

Weidmüller can supply fully assembled and labelled terminal strips to meet your specification.

ADL

The ADL cover can be clipped to a TS 32 terminal rail.

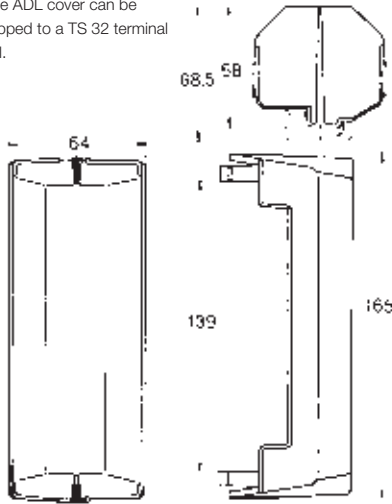

A selection of terminal types that can be fitted below this cover strip:

TS 32	
SAKD 2.5 N ... SAK 10	
EK 2.5 N ... EK 10	
SAKR, ASK 1, SAKT 1, SAKT 4, SAKB 10	
SAKS 1, SAKS 3	

Type	Qty.	Order No.
ADL	2	0210800000

AD 250

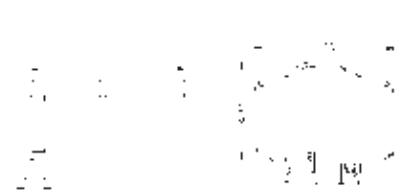

HP

retaining plate suitable for TS 32 and TS 35 x 7.5

height for TS 32: 64.5 mm

height for TS 35 x 7.5: 63 mm

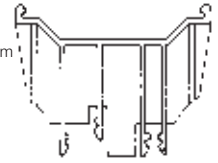

A selection of terminal types that can be fitted below this cover strip:

TS 32		TS 35	
SAKD 2.5 N ... SAK 10		WDU 2.5 to WDU 10	
EK 2.5 ... EK 10		WPE 2.5 to WPE 10	
SAKR, ASK 1, SAKT 1, SAKB 10		WNT 2.5 to WNT 10	
SAKS 1, SAKS 3		ASK 1,	
		SAKS 1/35, SAKS 3/35	

Type	Qty.	Order No.
AD 250 L = 250 mm	1	0634100000
HP EK1 32/2 AD 250	1	0634300000

Accessories for modular disconnect test terminals

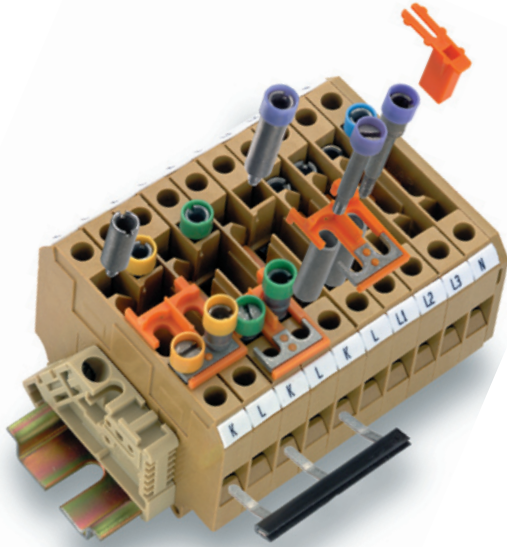

QVS... cross-connection sliders

VH 19 connecting sleeves and BS 25 fixing screws (or StB 35 sockets) are required for fixing the QVS cross-connections to the individual terminals.

The fixing screws include an insulating sleeve for colour coding purposes and a guide for the screwdriver. The cross-connection sliders are designed so that the test plug sockets in the terminals remain accessible in every position.

The type QVS 2S 2-pole version is designed so that it can be slid even when a test plug has been inserted. If a test option is required when a QVS has been fitted, the fixing is best achieved with the StB 35 socket.

The clearance and creepage values required for the rated voltage of the terminal change when accessories are fitted.

StB sockets are screwed into the busbar for the modular terminals. They are used to accommodate PS 4 test plugs or QS 2 plug-in cross-connectors.

QVSK 2 (167036)

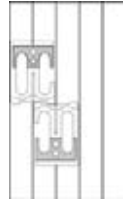

SAKT 2, SAKT 1

QVS 2 (030730)

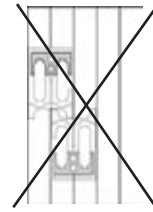

SAKT 1

Note:
QVS 2 units cannot be switched when installed like this.

Rated voltages

for adjacent	rated voltage
QVS	63 V
QL	250 V

for adjacent	rated voltage
StB 25	63 V
StB 35	63 V

TW partition plates or TSch insulating plates must be used to maintain the rated voltage.

The **SSP 3** and **SSP 4** prevent the unintended making or breaking of circuits. They lock the disconnection slider in its respective position. The lockout device can be easily pressed from above into the terminal and is then only removable with a tool.

Type	Qty.	Order No.
SSP 3	100	0531760000
SSP 4	20	1319360000

STB

Cross-connection sliders



QVS QVS QVSK 2 QVS 2S

STB

Sockets



Type	No. of poles	Qty.	Order No.
QVS 2	2 poles	20	0307300000
QVSK 2	2 poles	20	1670360000
QVS 3	3 poles	20	0329300000
QVS 4	4 poles	20	0307400000
QVS 2S	2 poles	20	0358460000

Type	Colour	Qty.	Order No.
STB 14			
STB 14		50	0169900000
STB 25			
STB 25	yellow	50	0267200000
STB 25	green	50	0271200000
STB 25	violet	50	0271300000
STB 25	black	50	0271500000
STB 25	grey	50	0271400000
STB 25	blue	50	0343400000
STB 25	red	50	0343300000
STB 30,5			
STB 30,5	yellow	50	0341500000
STB 30,5	green	50	0341400000
STB 30,5	violet	50	0341600000
STB 30,5	black	50	0341000000
STB 30,5	grey	50	0341100000
STB 30,5	blue	50	0341200000
STB 30,5	red	50	0341300000
STB 35			
STB 35	yellow	50	0389000000
STB 35	green	50	0388900000
STB 35	violet	50	0389100000
STB 35	black	50	0388500000
STB 35	grey	50	0388600000
STB 35	blue	50	0388700000
STB 35	red	50	0388800000

BS fixing screws

VH connecting sleeves

QL cross-connections

The QL cross-connections enable connections between adjacent modular terminals.

QL cross-connection links

QL cross-connection links are used as permanent, i.e. non-switchable, cross-connections on SAKT disconnect terminals. VH 12 connecting sleeves and BS M3 x 20 fixing screws (or StB 30.5 sockets) are required for fixing these in position. The clearance and creepage values required for the rated voltage of the terminal can change when accessories are fitted. This is especially true with cross-connections between neighbouring terminals with different potentials.

QB cross-connection comb

The QB can be inserted from above on the SAKT1/QT1 cross-connect/disconnect terminal.

The connection or disconnection is then achieved by means of the integral disconnection slider.

QS 2 plug-in cross-connection

For 4 mm dia. sockets, for up to 44 A.

BS / VH

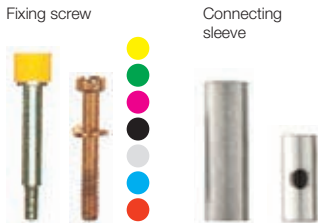

Type	Colour	Qty.	Order No.
Fixing screws			
BS 25	yellow	50	0335700000
BS 25	green	50	0335600000
BS 25	violet	50	0335800000
BS 25	black	50	0335200000
BS 25	grey	50	0335300000
BS 25	blue	50	0335400000
BS 25	red	50	0335500000
BS 25	uninsulated	50	0334700000
BS M 3 x 20		100	0377100000
CuNi 60 (copper alloy)			
Connecting sleeves			
VH 12		100	0249000000
E-Cu 57 (copper alloy)			
VH 19		50	0318000000
CuZn 39 (brass alloy)			

QL / Q

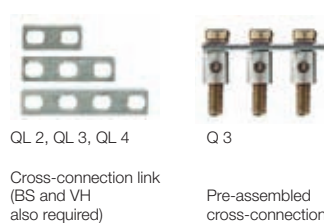

Type	No. of poles	Qty.	Order No.
QL 2, QL 3, QL 4			
QL 2	2 poles	50	0194300000
QL 3	3 poles	50	0194400000
QL 4	4 poles	50	0194500000
QL 5	5 poles	50	0220500000
QL 6	6 poles	50	0220600000
QL 10	10 poles	20	0338300000
QL 15	15 poles	10	0221200000
E-Cu 57 (copper alloy)			
Q2	2 poles	50	0456700000
Q3	3 poles	50	0456800000
Q4	4 poles	50	0456900000
Q10	10 poles	20	0457000000

QB



Type	No. of poles	Qty.	Order No.
QB 2, QB 3, QB 4			
QB 2	2 poles	50	0205700000
QB 3	3 poles	50	0205800000
QB 4	4 poles	50	0205900000
QB 10	10 poles	20	0343800000

QS 2



Type	No. of poles	Qty.	Order No.
QS 2	2 poles	20	0270960000
x = 8 mm, y = 16 mm			
QS 2	2 poles	20	0270860000
x = 10 mm, y = 20 mm			
QS 2	2 poles	20	0270760000
x = 12 mm, y = 20 mm			

Tools and ferrules

Tools and ferrules

Tools and ferrules

Cutting, stripping and crimping tools	J.2
Rechargeable and electric torque screwdriver	J.10
Screwdrivers	J.12
Wire end ferrules / Insulated cable lugs	J.21
Wire end ferrules with plastic collar	J.22
Twin-wire end ferrules with plastic collar	J.28
Wire end ferrules for short-circuit and earth-fault-proof cables	J.31
Wire end ferrules with plastic collar, special sizes	J.32
Wire end ferrules without plastic collar	J.33
Tools for insulated cable lugs and ferrules	J.35

Tools

Cutter

- Cutting formation for different cable sizes increases the quality of the cuts for smaller cross-sections.

KT 8

Notching tool



Cutting tool that does not damage the conductor; for cutting copper and aluminium cables with a diameter of up to 8 mm.

- Not suitable for steel wires, steel-armoured cables, aluminium alloys and hard-drawn copper conductors!

KT 12

Notching tool



Cutting tool that does not damage the conductor; for cutting copper and aluminium cables with a diameter of up to 12 mm.

- Not suitable for steel wires, steel-armoured cables, aluminium alloys and hard-drawn copper conductors!

J

Technical data

Max. cutting performance copper cable	
Solid (max. conductor cross-section)	mm ² / AWG
Stranded (max. conductor cross-section)	mm ² / AWG
Flexible (max. conductor cross-section)	mm ² / AWG
Flexible, Stranded (max. diameter)	mm
Sector line	
Max. cutting performance aluminium cable	
Stranded (max. conductor cross-section)	mm ² / AWG
Stranded (max. diameter)	mm
Solid	mm ²
Data-/ telephone-/ control cable	
O.D. max.	mm
Tool data	
Length / width / height	mm
Weight	g
Information	

KT8	
16 / 6	
16 / 6	
16 / 6	
8	
16 / 6	
8	
16	
8	
165 / 65 / 25	
180	
Tool closed	

KT12	
16 / 6	
25 / 3	
35 / 2	
12	
25 / 6	
8	
25	
12	
215 / 66 / 28	
300	
Tool closed	

Ordering data

Version	
Information	

Type	Qty.	Order No.
KT 8	1	9002650000
Information		

Type	Qty.	Order No.
KT 12	1	9002660000
Information		

Accessories

Type	Qty.	Order No.
Information		

Type	Qty.	Order No.
Information		

Type	Qty.	Order No.
Information		

WAW 1

Notching tool



Tool for trimming poles from WQV 2.5 to WQV 35 cross connections used in Weidmüller W-Series terminals.

Technical data

Length	167 mm
Weight	227 g

Ordering data

Type	Qty.	Order No.
WAW 1	1	9004500000

WAW 2

Notching tool



Tool for punching out the cross-connection windows of the Weidmüller W-Series, Test-disconnect terminal WTR 2.5, Fuse terminal WSI 6.

Technical data

Length	205 mm
Weight	338 g

Ordering data

Type	Qty.	Order No.
WAW 2	1	9004510000

KT ZQV

Cutter



Cutter for non-pinch cutting of Weidmüller Z-series cross-connections.

Technical data

Length	215 mm
Weight	300 g

Ordering data

Type	Qty.	Order No.
KT ZQV	1	9002170000

Tools

Stripping and cutting tools

- For flexible and massive conductors with PVC-insulation
- Stripping length adjustable with shoulder
- automatic opening of the clamping jaws after stripping
- no splicing of the single conductor
- adjustable to different insulation thicknesses
- cable with double insulation in two processing steps without special adjustment
- Blade-device free from float and self-adjustable
- long durability
- optimised ergonomically design

stripax®



stripax® 16



Stripping and cutting tool for flexible conductors with PVC-insulation of 0.08...6 mm² (~AWG 28...10)

- No damaging of the conductor due to special, self-adjustable stripping blades
- Processing of multi-conductors, with thin flat ribbon cables even multiple conductors in one operation

Stripping and cutting tool for flexible and massive conductors with PVC-insulation of 6...16 mm² (~AWG 10... 6)

- Cutting of flexible and massive conductors up to 6 mm² (AWG 10)
- No damaging of the conductor due to special blade forms

J

Technical data

Max. stripping performance	
Cable model	
Conductor cross-section	mm ²
Conductor diameter	mm
Max. stripping length	mm
Adjustable depth of cut	mm
Cutting performance	
Max. cutting performance	mm ²
Tool data	
Length	mm
Weight	g

Information

Ordering data

Version
Information

Accessories

Type	Qty.	Order No.
Cleaning brush	5	9005450000
Spare stripping blades	1	9054030000
Information		

stripax®	
flexible & solid conductors with PVC insulation	
Conductor cross-section	mm ²
Conductor diameter	mm
Max. stripping length	mm
Adjustable depth of cut	mm
Cutting performance	
Max. cutting performance	mm ²
Tool data	
Length	mm
Weight	g

Information

Type	Qty.	Order No.
STRIPAX	1	9005000000
Information		

Type	Qty.	Order No.
Cleaning brush	5	9005450000
Spare stripping blades	1	9054030000
Information		

stripax® 16	
flexible & solid conductors with PVC insulation	
Conductor cross-section	mm ²
Conductor diameter	mm
Max. stripping length	mm
Adjustable depth of cut	mm
Cutting performance	
Max. cutting performance	mm ²
Tool data	
Length	mm
Weight	g

Information

Type	Qty.	Order No.
STRIPAX 16	1	9005610000
Information		

Type	Qty.	Order No.
Cleaning brush	5	9005450000
Spare stripping blades	1	9054080000
Information		

Crimping and cutting tool for wire end ferrules

- Cutting
- Stripping
- Crimping
- Conductor entry sideways
- Wire end ferrules according to DIN 46228-4
- Ratchet for precise crimping
- Efficient operation:
Change of tools not necessary, therefore significant saving of time
- automatic transport of wire end ferrules
- Only wire end ferrules in strips of 50 pieces may be used with this tool. The use of wire end ferrules on reels can lead to damage.

stripax® plus 2.5

Cutting, stripping and crimping tool for wire end ferrules



Cutting, stripping and crimping tool for linked wire end ferrules on strip with 0.5...2.5 mm² (~AWG 20...14) from Weidmüller

- Easy handling of wire end ferrules
- Automatic feeding of wire end ferrules

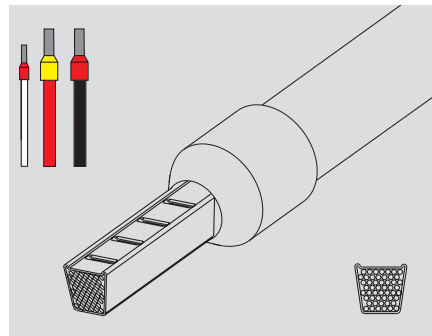

Technical data

Description of contact

Type of contact	
Crimping range	mm ²
Crimping range 1 (with multiple crimping positions)	mm ²
Crimping range 2 (with multiple crimping positions)	mm ²
Crimping range 3 (with multiple crimping positions)	mm ²
Plug width	mm

stripax® plus 2.5

Strip of wire end ferrules

0.5 ... 2.5
0.5 ... 0.75
1 ... 1.5
2.5

Tool data

Length	mm	210
Weight	g	260

Information

Only Weidmüller wire end ferrules on strips à 50 pieces may be used.

Ordering data

Version

Type	Qty.	Order No.
stripax plus 2,5	1	902000000

Information

Spare cutter (order no.: 9050340000)

Accessories

Information

Tools

Crimping tools for wire end ferrules

- Ratchet for precise crimping
- Release mechanism in case of incorrect operation
- Entry for wire end ferrule on the side

PZ 4

Crimping tool for wire end ferrules from 0.5...4 mm²



Crimping tool for wire end ferrules (to DIN 46228 part 1 and 4) with and without plastic collar and twin wire end ferrules of 0.5...2.5 mm²

- Only one crimping station for the whole cross-section

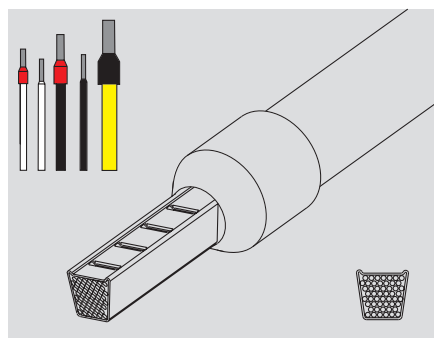

PZ 6/5

Crimping tool for wire end ferrules from 0.25...6 mm²



Crimping tool for wire end ferrules (to DIN 46228 pt. 1 and 4) with and without plastic collar of 0.25...6 mm² (~ AWG 24...10) and twin wire end ferrules of 0.5...4.0 mm²

- Crimp according to Euro-Norm EN 60947-1
- Five crimping stations corresponding to the conductor cross-section
- Approval according to VG 95211 (military designation VG 95 236 T 14 B 002)

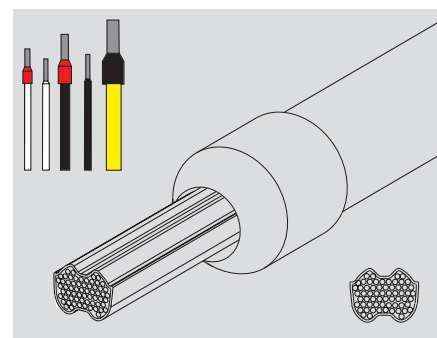

Technical data

Description of contact	
Type of contact	
Crimping range	mm ²
Crimping range 1 (with multiple crimping positions)	mm ²
Crimping range 2 (with multiple crimping positions)	mm ²
Crimping range 3 (with multiple crimping positions)	mm ²
Crimping range 4 (with multiple crimping positions)	mm ²
Crimping range 5 (with multiple crimping positions)	mm ²

Tool data	
Length	mm
Weight	g

Information	

Ordering data

Version

Information

Accessories

Information

PZ 4		
Wire end ferrules with/without plastic collar		
Crimping range	0.5 ... 4	

Length	mm	200
Weight	g	448

Information		

Type	Qty.	Order No.
PZ 4	1	9012500000

Information

Information

PZ 6/5		
Wire end ferrules with/without plastic collar		
Crimping range	0.25 ... 6	
	0.25 ... 0.5	
	0.75 ... 1.5	
	2.5	
	4	
	6	

Length	mm	200
Weight	g	423

Information		

Type	Qty.	Order No.
PZ 6/5	1	9011460000

Information

Information

Crimping tools for wire end ferrules

- Ratchet for precise crimping
- Release mechanism in case of incorrect operation

PZ 3

Crimping tool for wire end ferrules from 0.5...6 mm²



Crimping tool for wire end ferrules of 0.5...6 mm² with and without plastic collar according to DIN 46228 part 1 and 4 (~ AWG 20...10) and twin-wire end ferrules of 0.5...4 mm²

- Only one die for the whole cross-section
- Wire end ferrule insertion from the front

PZ 6 roto

Crimping tool for wire end ferrules from 0.14...6 mm²



Crimping tool for wire end ferrules of 0.14...6 mm² with and without plastic collar to DIN 46228 part 1 and 4 (~ AWG 26...10) and twin-wire end ferrules of 0.5...4 mm²

- Only one die for the whole cross-section
- Pivoted die for wire end ferrule-insertion
- Wire end ferrule insertion from the front or from the side

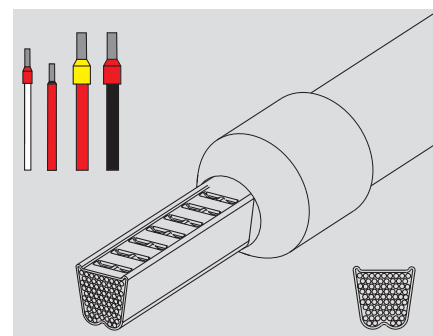
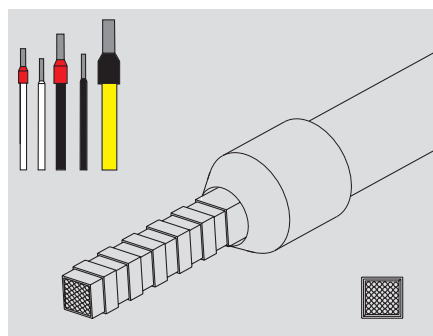

Technical data

Description of contact	
Type of contact	
Crimping range	mm ²
Crimping range 1 (with multiple crimping positions)	mm ²
Crimping range 2 (with multiple crimping positions)	mm ²
Crimping range 3 (with multiple crimping positions)	mm ²
Plug width	mm

PZ 3	
Wire end ferrules with/without plastic collar	
Crimping range	0.5 ... 6
Crimping range 1 (with multiple crimping positions)	
Crimping range 2 (with multiple crimping positions)	
Crimping range 3 (with multiple crimping positions)	
Plug width	

PZ 6 roto	
Wire end ferrules with/without plastic collar	
Crimping range	0.14 ... 6
Crimping range 1 (with multiple crimping positions)	
Crimping range 2 (with multiple crimping positions)	
Crimping range 3 (with multiple crimping positions)	
Plug width	

Tool data	
Length	mm
Weight	g
Information	

Length	mm	200
Weight	g	426
Information		

Length	mm	200
Weight	g	428
Information		

Ordering data

Version

Type	Qty.	Order No.
PZ 3	1	0567300000

Type	Qty.	Order No.
PZ 6 roto	1	9014350000

Information

Information

Information

Accessories

Information

Information

Information

Tools

Crimping tools for wire end ferrules

- Ratchet for precise crimping
- Release mechanism in case of incorrect operation
- Entry for wire end ferrule on the side

PZ 16

Crimping tool for wire end ferrules from 6...16 mm²



Crimping tool for wire end ferrules (to DIN 46228 part 1 and 4) with and without plastic collar from 6...16 mm² (~ AWG 10...6)

- Three crimping stations corresponding to the conductor cross-sections
- Crimp according to Euro-Norm EN 60947-1
- Approval according to VG 95211 (military designation VG 95 236 T 14 B 002)

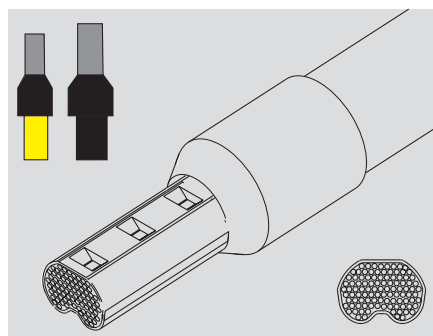

PZ ZH 16

Crimping tool for twin wire end ferrules, 6...16 mm²



Crimping tool for twin wire end ferrules (to DIN 46228 pt.4) with plastic collar from 6...16 mm² (~AWG 10...6)

- Three crimping stations corresponding to the conductor cross-sections

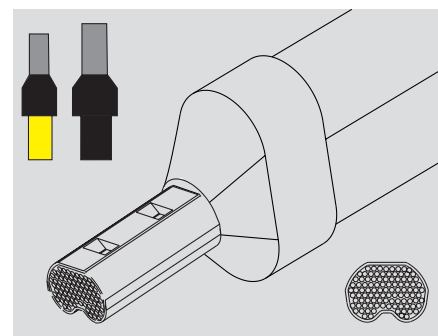

Technical data

Description of contact	
Type of contact	
Crimping range	mm ²
Crimping range 1 (with multiple crimping positions)	mm ²
Crimping range 2 (with multiple crimping positions)	mm ²
Crimping range 3 (with multiple crimping positions)	mm ²
Plug width	mm

Tool data	
Length	mm
Weight	g
Information	

Ordering data

Version

Information

Accessories

Information

PZ 16		
Wire end ferrules with/without plastic collar		
Crimping range	6 ... 16	
Crimping range 1	6	
Crimping range 2	10	
Crimping range 3	16	

Tool data		
Length	200	
Weight	418	
Information		

Type	Qty.	Order No.
PZ 16	1	901260000

Information

Information

PZ ZH 16		
Twin wire end ferrules		
Crimping range	6 ... 16	
Crimping range 1	6	
Crimping range 2	10	
Crimping range 3	16	

Tool data		
Length	260	
Weight	700	
Information		

Type	Qty.	Order No.
PZ ZH 16	1	901360000

Information

Information

Crimping tools for wire end ferrules

- Ratchet for precise crimping
- Release mechanism in case of incorrect operation

PZ 50

Crimping tool for wire end ferrules with 25, 35 and 50 mm²



Crimping tool for wire end ferrules of 25, 35 and 50 mm² with and without plastic collar to DIN 46228 part 1 and 4(- AWG 3...1)

- Three crimping stations corresponding to the conductor cross-sections
- Crimp according to Euro-Norm EN 60947-1
- Approval according to VG 95211 (military designation VG 95 236 T 14 B 002)

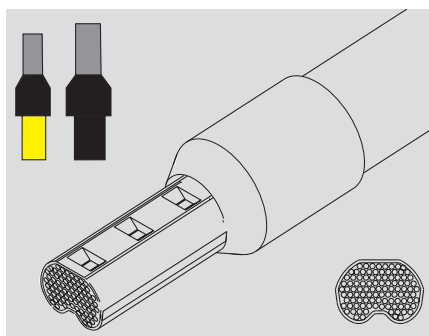

Technical data

Description of contact	
Type of contact	
Crimping range	mm ²
Crimping range 1 (with multiple crimping positions)	mm ²
Crimping range 2 (with multiple crimping positions)	mm ²
Crimping range 3 (with multiple crimping positions)	mm ²
Plug width	mm

PZ 50	
Wire end ferrules with/without plastic collar	
25 ... 50	
25	
35	
50	

Tool data	
Length	mm
Weight	g
Information	

260
700

Ordering data

Version

Type	Qty.	Order No.
PZ 50	1	9006450000

Information

Accessories

Information

--

--

Tools

Rechargeable torque screwdriver

DMS 3



DMS 3 Set



DMS 3 rechargeable torque screwdriver

- One-hand operation under all working conditions
- Switchable forward and reverse
- Two speeds: 200 and 400 rpm
- Precise torque settings from approx. 0.2 ... 3 Nm in 6 steps
- Consistent performance during battery discharge
- Grip swings easily from rod to pistol form
- Takes 1/4" bits held ball-bearing clamping mechanism (form E6.3)
- Safety lock prevents inadvertent operation
- Easy changeover from battery drive to manual operation up to 15 Nm

Technical data

Screwdriver	
Motor	2.4 V DC
Idling speed	200/400 min ⁻¹
Max. torque	3.0 Nm
Chuck	1/4" E 6.3 DIN 3126
Length	239 mm
Weight	400 g
Battery	
Type	2 Ni-Cd batteries each 1.2 V
Weight	122 g
Charger	
Input	230 V AC, 50 Hz, 50 mA
Output	2.9 V AC, 1.4 A, 4.1 VA
Charging time	1 hour
Weight	700 g

Ordering data

Type	Qty.	Order No.
DMS 3	1	9007440000
Screwdriver incl. battery		

Accessories

Type	Qty.	Order No.
Spare battery	1	9007450000
Charger	1	9007460000

Type	Qty.	Order No.
DMS 3 set 1 (screwdriver incl. battery, charger, bits, plastic carrying case)*	1	9007470000
DMS 3 set 2 (as set1 with 1 additional battery)	1	9007480000

*) refer to figure

Electric torque screwdriver

DMS 2 Set



- Torque adjustable in four steps for standard screws M2.5 to M4
- Selectable electric power cut-off upon reaching a preselected torque
- High repetition accuracy
- Start-up in low gear and switchover to operating rpm is controlled via the pressure on the screw head
- Switchable forward and reverse
- Fatigue-free working due to ergonomic design and low weight
- Ideal design for one-hand operation under all working conditions and at different working locations
- Low noise
- Low energy consumption

Technical data

Rated voltage	230 V
Frequency	60 Hz
Rated power	45 W
Current consumption	0.2 A
rpm of spindle in search gear	350 min ⁻¹
in working mode	700 min ⁻¹
Torques	
Level 1 (M 2.5)	0.5 ± 0.1 Nm
Level 2 (M 3)	0.7 ± 0.15 Nm
Level 3 (M 3.5)	1.2 ± 0.2 Nm
Level 4 (M4)	1.7 ± 0.25 Nm
Weight incl. supply cable	0.990 kg
Weight	0.820 kg
Noise level to DIN 45 634	58 db (A)
Protection class II to DIN 57 740	
DIN/VDE 0740 T.1 and T.2	
EMC to EC directive 89/336/EWG	
CE mark	

Ordering data

Standard equipment	Type	Qty.	Order No.
	DMS 2 with 1/4" drive	1	0664600000
	Form E 6.3 DIN 3126 with hang-up clip and 4 bits for slotted screws (Length: 50 mm)		
	Blade dimensions 0.5 x 3 / 0.6 x 3.5 / 0.8 x 4 / 1.0 x 5.5		

Accessories

Type	Qty.	Order No.
BAL 2 (balancer for hanging up the DMS 2)	1	0181800000

Screwdrivers

Screwdrivers

Weidmüller screwdrivers come in four different grip sizes, and are the result of a consistent grip concept which takes into account both the human hand and the different requirements when working

- Perfect handling with all grip sizes
- Maximum torques
- Optimum transmission of axial force
- Complete range including all commercial dimensions



SoftFinish-grip

With the SoftFinish zone for use in dry conditions and for general applications, Weidmüller offers a complete range of screwdrivers that enables far higher torques and at the same time substantially more comfort due to the soft material of the grip.

Product benefits:

- Made of special soft material which is kind to the skin, the SoftFinish zone enables maximum torques
- Perfect ergonomic grip design for comfortable screw driving and optimum handling
- Version with solid steel tip can be used for chiselling
- You can choose from long-life extremely stressable blades in standard sizes
- ChromTop blade tip offers maximum corrosion protection and greatest possible dimensional accuracy of the blade geometry in the screw head over many years

SoftFinish electric

VDE-insulated screwdriver according to DIN EN 60900, IEC 900 for work on live equipment

Product benefits:

- The protective insulation directly injected onto the screwdriver blade ensures electrical safety, even in critical applications
- Safe for working at up to 1500 volts DC and 1000 volts AC
- Each screwdriver is individually tested in a water bath at 10,000 volts according to DIN EN 60900
- Perfect ergonomic grip design for comfortable screw driving and optimum handling
- Made of special soft material which is kind to the skin, the SoftFinish zone prevents slipping in critical situations and at the same time enables maximum torques

Combined cutting and screw driving tool

that does not damage the edge; for cutting of copper cables with a diameter of up to 1.5 mm² solid and 2.5 mm² flexible.

swifty®



swifty®

- Cable cutting tool to mount on non-insulated screw drivers with a blade diameter of 3.5 mm
- Minimum manual force required
- Automatic opening of the cutter
- Ergonomically designed grip

swifty®set

- Efficient operation:
- Only one tool for cable-processing in IDC-technology
- Suitable for screw and tension clamps
- Readily available pocket size
- For right-handed and left-handed use
- One-hand operation

swifty®set



Technical data

Maximum cutting capacity		
Copper cable:		
Solid cable (conductor cross-section)	mm ²	1.5
Flexible cable (conductor cross-section)	mm ²	2.5
Tool data		
Length x width x height	mm	35 / 18 / 40
Weight	g	20

Ordering data

Type	Qty.	Order No.
swifty® (without screwdriver)	1	9006020000

Type	Qty.	Order No.
swifty®set (with screwdriver)	1	9006060000
Screwdriver (SD 0.6 3.5x100)	1	9008330000

Tools

VDE insulated screwdriver

VDE insulated screwdriver sets, for working on live parts up to 1000 V AC and 1500 V DC, DIN EN 60900, IEC 900. safety tested GS, every one tested. Blade made from fully hardened, high-alloy chromium-vanadium-molybdenum steel, gunmetal finish.



SDI S

VDE insulated slot-head screwdriver, SDI DIN 7437, ISO 2380/2, output to DIN 5264, ISO 2380/1, SoftFinish grip



Type	Size / SW	A	B	C	Order No.
SDI 0.4 x 2.5 x 75		0.4	2.5	80	9008370000
SDI 0.5 x 3.0 x 100		0.5	3.0	100	9008380000
SDI 0.6 x 3.5 x 100		0.6	3.5	100	9008390000
0.8 x 4.0 x 100		0.8	4.0	100	9008400000
SDI 1.0 x 4.5 x 125		1.0	4.5	125	9008910000
SDI 1.0 x 5.5 x 125		1.0	5.5	125	9008410000
SDI 1.2 x 6.5 x 150		1.2	6.5	125	9025870000
SDI 1.6 x 8.0 x 175		1.6	8.0	175	9008430000
SDI 0.4 x 2.0 x 60		0.4	2.0	60	9205690000
SDI 1.0 x 4.5 x 175		1.0	4.5	175	9205700000
SDI 1.0 x 5.5 x 175		1.0	5.5	175	9205710000

SDIK PH

VDE insulated crosshead screwdriver, for Phillips screws, SDIK PH DIN 7438, ISO 8764/2-PH, output to ISO 8764-PH, SoftFinish grip



SDIK PH0	0	60	9008560000
SDIK PH1	1	80	9008570000
SDIK PH2	2	100	9008580000
SDIK PH3	3	150	9008590000

SDIK PZ

VDE insulated crosshead screwdriver type Pozidriv SDIK PZ DIN 7438, ISO 8764/2-PZ, output to ISO 8764-PZ, SoftFinish grip



SDIK PZ1	1	80	9008900000
SDIK PZ2	2	100	9008890000

SDIT

VDE insulated Torx®-screwdriver, SDIT SoftFinish grip



SDI T8	8	60	9201940000
SDI T10	10	80	9009640000
SDI T15	15	80	9009650000
SDI T20	20	80	9009660000
SDI T25	25	80	9009670000
SDI T30	30	100	9009680000
SDI T35	40	150	9009690000

SKI

VDE insulated hexagon socket wrench, SKI SoftFinish grip



SKI 5.0 x 125	5	125	9009000000
SKI 5.5 x 125	5.5	125	9008990000
SKI 6.0 x 125	6	125	9008980000
SKI 7.0 x 125	7	125	9008970000
SKI 8.0 x 125	8	125	9008960000
SKI 9.0 x 125	9	125	9008950000
SKI 10.0 x 125	10	125	9008940000
SKI 11.0 x 125	11	125	9008930000
SKI 13.0 x 125	13	125	9008920000

Information

Uninsulated screwdriver

Weidmüller SoftFinish screwdriver for general uses, blade made from fully hardened, high-alloy chromium-vanadium-molybdenum steel, matt chrome finish.



SDI S

Slotted screwdriver with round blade SD DIN 5265, ISO 2380/2, output to DIN 5264, ISO 2380/1, ChromTop tip, SoftFinish grip



Type	Size / SW	A	B	C	Order No.
SD 0.4 x 2.0 x 60		0.4	2.0	60	9037160000
SD 0.4 x 2.5 x 75		0.4	2.5	75	9009030000
SD 0.5 x 3.0 x 80		0.5	3.0	80	9008320000
SD 0.6 x 3.5 x 100		0.6	3.5	100	9008330000
SD 0.6 x 3.5 x 200		0.6	3.5	200	9010110000
SD 0.8 x 4.0 x 100		0.8	4.0	100	9008340000
SD 1.2 x 6.5 x 150		1.2	6.5	150	9009010000
SD 0.8 x 4.5 x 125		0.8	4.5	125	9009020000
SD 1.0 x 5.5 x 150		1.0	5.5	150	9008350000

SDK PH

Crosshead screwdriver, Phillips, SDK PH DIN 5262, ISO 8764/2-PH, output to ISO 8764-PH, ChromTop tip, SoftFinish grip



SDK PH0	0	60	9008470000
SDK PH1	1	80	9008480000
SDK PH2	2	100	9008490000
SDK PH3	3	150	9008500000

SDK PZ

Crosshead screwdriver, Pozidriv, SDK PZ DIN 5262, ISO 8764/2-PZ, output to ISO 8764/1-PZ, ChromTop tip, SoftFinish grip



SDK PZ0	0	60	9008520000
SDK PZ1	1	80	9008530000
SDK PZ2	2	100	9008540000
SDK PZ3	3	150	9008550000

SD TH

Torx® TH screwdriver with hole in tip of blade (tamper-resistant), SD TH for screwing Torx® and Torx®-TH security screws (pin in centre of Torx recess), ChromTop tip, SoftFinish grip



SD TH8	8	60	9009190000
SD TH10	10	80	9009180000
SD TH15	15	80	9009170000
SD TH20	20	100	9009160000
SD TH25	25	100	9009150000
SD TH30	30	115	9009140000

SK

Hexagon socket wrench SK DIN 3125, output to DIN 3125, SoftFinish grip



SK 5.5 x 125	5,5	125	9009120000
SK 6.0 x 125	6	125	9009110000
SK 7.0 x 125	7	125	9009100000
SK 8.0 x 125	8	125	9009090000
SK 9.0 x 125	9	125	9009080000
SK 10.0 x 125	10	125	9009070000
SK 11.0 x 125	11	125	9009060000
SK 12.0 x 125	12	125	9009050000
SK 13.0 x 125	13	125	9009040000

Information

Tools

Wrench set Weidmüller

Allen key made from fully hardened, high-alloy chromium-vanadium-steel, to DIN ISO 2936 L (DIN 911), surface high-quality refined.



SK WSD S

9-piece offset screwdriver set in Prostar holder, with **MagicRing**: holds standard screws (size 3 and larger) in any position thanks to spring steel ring, with **ball point**: for working at angles up to 25°.



Type	Size / SW	A	B	C	Order No.
	1.5				
	2				
	2.5				
	3				
	4				
	5				
	6				
	8				
	10				
SK WSD-S 1.5-10.0					9008850000

SK S

7-piece Allen key set



	2				
	2.5				
	3				
	4				
	5				
	8				
	6				
SKS 2.0-8.0					9008860000

SK S

7-piece Allen key set with MagicRing and ball point: holds standard screws (size 3 and larger) in any position thanks to spring steel ring, with ball point: for working at angles up to 25°.



	2				
	2.5				
	3				
	4				
	5				
	6				
	8				
SKS 2.0-8.0 MR					9008870000

TH S

8-piece Torx®-TH screwdriver set with hole in the blade point (tamper-proof), for screwing Torx® and Torx®-TH tamper-proof screws (centre pin in profile)

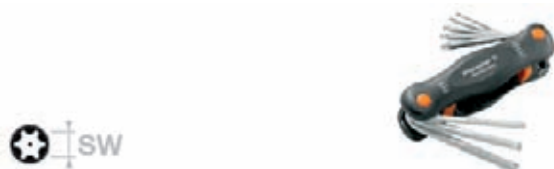

	9				
	10				
	15				
	20				
	25				
	27				
	30				
	40				
TH-S 9-40					9008880000

Information

DMS manual / DMSI manual

Torque screwdrivers with insulation up to 1000 V (VDE)

• DMSI manual

The “DMSI manual” with integral window torque scale combined with a Weidmüller 1000 V insulated (VDE) interchangeable blade ensures controlled tightening of screws plus reliability in electrical applications.

Every 1000 V insulated handle (VDE) and blade (VDE) is tested and provides the necessary safety up to 1000 V AC/1500 V DC.



Torque screwdrivers

• DMS manual

This is a versatile tool suitable for a variety of jobs, with integral scale for easy reading of the torque value plus a Weidmüller interchangeable blade.



Scale

Each model is available with two torque ranges:

- 0.5 to 1.7 Nm
- 2.0 to 8.0 Nm
- setting tool included

Advantages:

- Compact and especially lightweight design
- Torque set with special tool (included) to ensure the right setting
- Ergonomic handle size to match the torque range
- Every tool checked and given an ID No., 100% quality control with verification and product reference
- Audible, unmistakable click upon reaching the torque, no unnecessary effort
- Interchangeable blade made from high-quality wear-resistant tool steel
- All tools comply with the accuracy stipulations of: EN ISO 6798, BS EN 26789, ASME B107.14M
- Operating accuracy: $\pm 6\%$ of set scale value



Setting tool

Tools

Uninsulated torque screwdriver



DMS manual

Torque-screwdriver
EN ISO 6798, BS EN 26789, ASME B107.14M



Type	Size / SW	A	B	C	Order No.
DMS MANUELL 0.5-1.7	0.5 - 1.7 Nm				9918370000
DMS MANUELL 2.0-8.0	2.0 - 8.0 Nm				9918380000

WK K S

Interchangeable blades for torque-screwdriver
output according to DIN 5264, ISO 2380/1



WK S 0.4 x 2.5	max. 0.6 Nm	0.4	2.5	175	9918520000
WK S 0.5 x 3.0	max. 0.6 Nm	0.5	3.0	175	9918530000
WK S 0.6 x 3.5	max. 1.1 Nm	0.6	3.5	175	9918540000
WK S 0.8 x 4.0	max. 2.5 Nm	0.8	4.0	175	9918550000
WK S 1.0 x 5.5	max. 3.8 Nm	1.0	5.5	175	9918560000

WK K PZ

Interchangeable blades for torque-screwdriver
output according to DIN 5260-PZ, ISO 8764/1-PZ



WK K PZ0	max. 0.9 Nm			175	9918600000
WK K PZ1	max. 3.8 Nm			175	9918610000
WK K PZ2	max. 5.5 Nm			175	9918620000

WK K PH

Interchangeable blades for torque-screwdriver
output according to DIN 5260-PH, ISO 8764/1-PH



WK K PH0	max. 0.9 Nm			175	9918570000
WK K PH1	max. 3.8 Nm			175	9918580000
WK K PH2	max. 5.5 Nm			175	9918590000

Information

VDE insulated torque screwdriver

VDE insulated torque screwdriver Weidmüller SoftFinish electric for work on live parts up to 1000 Vac and 1500 Vdc, DIN EN 60900, IEC 900. GS symbol, every one tested.



DMSI manual

VDE insulated torque-screwdriver
EN ISO 6798, BS EN 26789, ASME B107.14M



Type	Size / SW	A	B	C	Order No.
DMSI MANUELL 0.5-1.7	0.5 - 1.7 Nm				9918390000
DMSI MANUELL 2.0-8.0	2.0 - 8.0 Nm				9918400000

WK SI

VDE insulated interchangeable blades for VDE insulated torque-screwdriver
output according to DIN 5264, ISO 2380/1



WK SI 0.4 x 2.5	max. 0.6 Nm	0.4	2.5	175	9918410000
WK SI 0.5 x 3.0	max. 0.6 Nm	0.5	3.0	175	9918420000
WK SI 0.6 x 3.5	max. 1.1 Nm	0.6	3.5	175	9918430000
WK SI 0.8 x 4.0	max. 2.5 Nm	0.8	4.0	175	9918440000
WK SI 1.0 x 5.5	max. 3.8 Nm	1.0	5.5	175	9918450000

WK IK PH

VDE insulated interchangeable blades for VDE insulated torque-screwdriver
output according to DIN 5260-PH, ISO 8764/1-PH



WK IK PH0	max. 0.9 Nm			175	9918460000
WK IK PH1	max. 3.8 Nm			175	9918470000
WK IK PH2	max. 5.5 Nm			175	9918480000

WK IK PZ

VDE insulated interchangeable blades for VDE insulated torque-screwdriver
output according to DIN 5260-PZ, ISO 8764/1-PZ



WK IK PZ0	max. 0.9 Nm			175	9918490000
WK IK PZ1	max. 3.8 Nm			175	9918500000
WK IK PZ2	max. 5.5 Nm			175	9918510000

Information

Wire end ferrules / Insulated cable lugs

Weidmüller stocks a comprehensive range of wire end ferrules and insulated cable lugs for immediate supply.

Wire end ferrules

Wire end ferrules ensure the long-term quality of electrical connections. Another advantage is their usefulness during installation. The wide range of products embraces wire end ferrules with or without plastic collars and twin wire end ferrules in all the colours normally required by users.



Insulated cable lugs

Insulated cable lugs ensure the long-term quality of electrical connections. Most of the products in the range (apart from the butt connectors) have a conical inlet. This guarantees optimum entry of the conductor as the strands are automatically centred.



Wire end ferrules with plastic collar

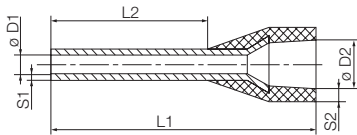

- Polypropylene conical cable entry
- Heat-resistant up to 105 °C
- Cable entry made from a not readily flammable material on request

For conductors from 0.14 to 150 mm² (AWG 26-300MCM)
Tin-plated copper
Dimensional tolerances to DIN 46228 part 4

Weidmüller colour code

packed loose

Ordering data

Type	ø mm ²	AWG	L1	L2	D1	D2	S1	S2	Stripping length	Colour	Qty.	Order No.
H0.25/10	0.25	24	10.0	6.0	0.8	1.8	0.15	0.25	8.0	● light blue	500	9025740000
H0.25/12	0.25	24	12.0	8.0	0.8	1.8	0.15	0.25	10.0	● light blue	500	9025760000
H0.34/10	0.34	22	10.0	6.0	0.8	2.0	0.15	0.25	8.0	● turquoise	500	9025750000
H0.34/12	0.34	22	12.0	8.0	0.8	2.0	0.15	0.25	10.0	● turquoise	500	9025770000
H0.5/12	0.50	20	12.0	6.0	1.0	2.6	0.15	0.25	8.0	● orange	500	0409500000
H0.5/14	0.50	20	14.0	8.0	1.0	2.6	0.15	0.25	10.0	● orange	500	0690700000
H0.5/16	0.50	20	16.0	10.0	1.0	2.6	0.15	0.25	12.0	● orange	500	9025870000
H0.75/12	0.75	18	12.0	6.0	1.2	2.8	0.15	0.25	8.0	○ white	500	0409600000
H0.75/14	0.75	18	14.0	8.0	1.2	2.8	0.15	0.25	10.0	○ white	500	0462900000
H0.75/16	0.75	18	16.0	10.0	1.2	2.8	0.15	0.25	12.0	○ white	500	9025860000
H0.75/18	0.75	18	18.0	12.0	1.2	2.8	0.15	0.25	14.0	○ white	500	9025910000
H1.0/12	1.00	17	12.0	6.0	1.4	3.0	0.15	0.25	8.0	● yellow	500	0409700000
H1.0/14	1.00	17	14.0	8.0	1.4	3.0	0.15	0.25	10.0	● yellow	500	0463000000
H1.0/16	1.00	17	16.0	10.0	1.4	3.0	0.15	0.25	12.0	● yellow	500	9025950000
H1.0/18	1.00	17	18.0	12.0	1.4	3.0	0.15	0.25	15.0	● yellow	500	9025930000
H1.5/14	1.50	16	14.0	8.0	1.7	3.5	0.15	0.25	10.0	● red	500	0463100000
H1.5/16	1.50	16	16.0	10.0	1.7	3.5	0.15	0.25	12.0	● red	500	0635100000
H1.5/24	1.50	16	24.0	18.0	1.7	3.5	0.15	0.25	20.0	● red	500	0565600000
H2.5/14D	2.50	14	14.0	8.0	2.2	4.2	0.15	0.25	10.0	● blue	500	9019160000
H2.5/18D	2.50	14	18.0	12.0	2.2	4.2	0.15	0.25	14.0	● blue	500	9019170000
H2.5/24D	2.50	14	24.0	18.0	2.2	4.2	0.15	0.25	20.0	● blue	500	9019180000
H4.0/17D	4.00	12	17.0	10.0	2.8	4.8	0.2	0.3	12.0	● grey	500	9019190000
H4.0/20D	4.00	12	20.0	12.0	2.8	4.8	0.2	0.3	14.0	● grey	500	9019200000
H4.0/26D	4.00	12	26.0	18.0	2.8	4.8	0.2	0.3	20.0	● grey	100	9019210000
H6.0/20	6.00	10	20.0	12.0	3.5	6.3	0.2	0.3	14.0	● black	100	0533500000
H6.0/26	6.00	10	26.0	18.0	3.5	6.3	0.2	0.3	20.0	● black	100	0565700000
H10.0/22	10.00	7	22.0	12.0	4.5	7.6	0.2	0.4	15.0	● ivory	100	0534200000
H10.0/28	10.00	7	28.0	18.0	4.5	7.6	0.2	0.4	21.0	● ivory	100	0565800000
H16.0/24	16.00	6	24.0	12.0	5.8	8.8	0.2	0.4	15.0	● green	100	0565900000
H16.0/28	16.00	6	28.0	18.0	5.8	8.8	0.2	0.4	21.0	● green	100	0566000000
H25.0/30	25.00	3	30.0	16.0	7.3	11.2	0.2	0.4	18.0	● brown	50	0317000000
H25.0/36	25.00	3	36.0	22.0	7.3	11.2	0.2	0.4	24.0	● brown	50	0317100000
H35.0/30	35.00	2	30.0	16.0	8.3	12.7	0.2	0.4	19.0	● beige	50	0317200000
H35.0/39	35.00	2	39.0	25.0	8.3	12.7	0.2	0.4	28.0	● beige	50	0317300000
H50.0/36	50.00	1	36.0	20.0	10.3	15.0	0.3	0.5	26.0	● olive green	50	0444200000
H70.0/40	70.00	2/0	37.0	20.0	12.7	16.0	0.35	0.6	26.0	● yellow	25	9028200000
H95.0/44	95.00	3/0	44.0	25.0	14.7	18.0	0.35	0.6	31.0	● red	25	9028210000
H120.0/50	120.00	4/0	50.0	30.0	16.5	21.0	0.5	0.7	36.0	● blue	25	9028220000
H150.0/54	150.00	300 MCM	54.0	32.0	18.5	23.5	0.5	0.75	38.0	● yellow	25	9028230000

Weidmüller colour code

in multipack bag

Ordering data

Type	ø mm ²	AWG	L1	L2	D1	D2	S1	S2	Stripping length	Colour	Qty.	Order No.
H0.14/10	0.14	26	10.0	6.0	0.6	1.5	0.15	0.25	8.0	● grey	500	9005180000
H0.14/12	0.14	26	12.0	8.0	0.6	1.5	0.15	0.25	10.0	● grey	500	9028240000
H0.25/10	0.25	24	10.0	6.0	0.8	1.8	0.15	0.25	8.0	● light blue	500	9026050000
H0.25/12	0.25	24	12.0	8.0	0.8	1.8	0.15	0.25	10.0	● light blue	500	9025780000
H0.34/10	0.34	22	10.0	6.0	0.8	2.0	0.15	0.25	8.0	● turquoise	500	9026030000
H0.34/12	0.34	22	12.0	8.0	0.8	2.0	0.15	0.25	10.0	● turquoise	500	9025790000
H0.5/10	0.50	20	10.0	6.0	1.0	2.6	0.15	0.25	8.0	● orange	500	9028260000
H0.5/14	0.50	20	14.0	8.0	1.0	2.6	0.15	0.25	10.0	● orange	500	9026060000
H0.5/16	0.50	20	16.0	10.0	1.0	2.6	0.15	0.25	12.0	● orange	500	9028270000
H0.75/12	0.75	18	12.0	6.0	1.2	2.8	0.15	0.25	8.0	○ white	500	9028280000
H0.75/14	0.75	18	14.0	8.0	1.2	2.8	0.15	0.25	10.0	○ white	500	9026070000
H0.75/16	0.75	18	16.0	10.0	1.2	2.8	0.15	0.25	12.0	○ white	500	9028290000
H0.75/18	0.75	18	18.0	12.0	1.2	2.8	0.15	0.25	14.0	○ white	500	9028300000
H1.0/12	1.00	17	12.0	6.0	1.4	3.0	0.15	0.25	8.0	● yellow	500	9028310000
H1.0/14	1.00	17	14.0	8.0	1.4	3.0	0.15	0.25	10.0	● yellow	500	9026080000
H1.0/16	1.00	17	16.0	10.0	1.4	3.0	0.15	0.25	12.0	● yellow	500	9028320000
H1.0/18	1.00	17	18.0	12.0	1.4	3.0	0.15	0.25	15.0	● yellow	500	9028340000
H1.5/14	1.50	16	14.0	8.0	1.7	3.5	0.15	0.25	10.0	● red	500	9026090000
H1.5/16	1.50	16	16.0	10.0	1.7	3.5	0.15	0.25	12.0	● red	500	9028350000
H2.5/14	2.50	14	14.0	8.0	2.2	4.2	0.15	0.25	10.0	● blue	500	9026100000
H4.0/17	4.00	12	17.0	10.0	2.8	4.8	0.2	0.3	12.0	● grey	250	9026010000

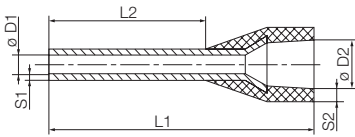

- Polypropylene conical cable entry
- Heat-resistant up to 105 °C
- Cable entry made from a not readily flammable material on request

For conductors from 0.5 to 2.5 mm² (AWG 22-14)
Tin-plated copper
Dimensional tolerances to DIN 46228 part 4

Weidmüller colour code

Strip of wire end ferrules

Ordering data

Type	ø mm ²	AWG	L1	L2	D1	D2	S1	S2	Stripping length	Colour	Qty.	Order No.
H0.5/14	0.50	20	14.0	8.0	1.0	2.6	0.15	0.25	10.0	● orange	500	9004270000
H0.75/14	0.75	18	14.0	8.0	1.2	2.8	0.15	0.25	10.0	○ white	500	9004290000
H1.0/14	1.00	17	14.0	8.0	1.4	3.0	0.15	0.25	10.0	● yellow	500	9004320000
H1.5/14	1.50	16	14.0	8.0	1.7	3.2	0.15	0.25	10.0	● red	500	9004340000
H2.5/14D	2.50	14	14.0	8.0	2.2	4.0	0.15	0.25	11.0	● blue	500	9004360000

Weidmüller colour code

Reel of wire end ferrules

Ordering data

Type	ø mm ²	AWG	L1	L2	D1	D2	S1	S2	Stripping length	Colour	Qty.	Order No.
H0.34/12	0.34	22	12.0	8.0	0.8	2.0	0.15	0.25	10.0	● turquoise	5000	9004390000
H0.5/14	0.50	20	14.0	8.0	1.0	2.6	0.15	0.25	10.0	● orange	5000	9005810000
H0.75/14	0.75	18	14.0	8.0	1.2	2.8	0.15	0.25	10.0	○ white	5000	9005820000
H1.0/14	1.00	17	14.0	8.0	1.4	3.0	0.15	0.25	11.0	● yellow	5000	9005830000
H1.5/14	1.50	16	14.0	8.0	1.7	3.2	0.15	0.25	10.0	● red	5000	9005840000
H2.5/14D	2.50	14	14.0	8.0	2.2	4.0	0.15	0.25	11.0	● blue	3000	9005850000

Wire end ferrules with plastic collar

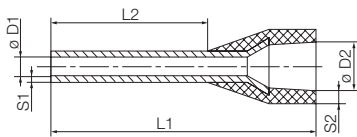

- Polypropylene conical cable entry
- Heat-resistant up to 105 °C
- Cable entry made from a not readily flammable material on request

For conductors from 0.5 to 50 mm² (AWG 20-1)
Tin-plated copper
Dimensional tolerances to DIN 46228 part 4

DIN colour code

packed loose

Ordering data

Type	ø mm ²	AWG	L1	L2	D1	D2	S1	S2	Stripping length	Colour	VG*	Qty.	Order No.
H0.5/12D	0.50	20	12.0	6.0	1.0	2.6	0.15	0.25	8.0	○ white	T 20A 001 A	500	9019000000
H0.5/14D	0.50	20	14.0	8.0	1.0	2.6	0.15	0.25	10.0	○ white	T 20A 002 A	500	9019010000
H0.5/16D	0.50	20	16.0	10.0	1.0	2.6	0.15	0.25	12.0	○ white	T 20A 003 A	500	9019020000
H0.75/12D	0.75	18	12.0	6.0	1.2	2.8	0.15	0.25	8.0	● grey	T 20A 004 A	500	9019030000
H0.75/14D	0.75	18	14.0	8.0	1.2	2.8	0.15	0.25	10.0	● grey	T 20A 005 A	500	9019040000
H0.75/16D	0.75	18	16.0	10.0	1.2	2.8	0.15	0.25	12.0	● grey	T 20A 006 A	500	9019050000
H0.75/18D	0.75	18	18.0	12.0	1.2	2.8	0.15	0.25	14.0	● grey	T 20A 007 A	500	9019060000
H1.0/12D	1.00	17	12.0	6.0	1.4	3.0	0.15	0.25	8.0	● red	T 20A 008 A	500	9019070000
H1.0/14D	1.00	17	14.0	8.0	1.4	3.0	0.15	0.25	10.0	● red	T 20A 009 A	500	9019080000
H1.0/16D	1.00	17	16.0	10.0	1.4	3.0	0.15	0.25	12.0	● red	T 20A 010 A	500	9019100000
H1.0/18D	1.00	17	18.0	12.0	1.4	3.0	0.15	0.25	15.0	● red	T 20A 011 A	500	9019110000
H1.5/14D	1.50	16	14.0	8.0	1.7	3.5	0.15	0.25	10.0	● black	T 20A 012 A	500	9019120000
H1.5/16D	1.50	16	16.0	10.0	1.7	3.5	0.15	0.25	12.0	● black	T 20A 013 A	500	9019130000
H1.5/18D	1.50	16	18.0	12.0	1.7	3.5	0.15	0.25	15.0	● black	T 20A 014 A	500	9019140000
H1.5/24D	1.50	16	24.0	18.0	1.7	3.5	0.15	0.25	20.0	● black	T 20A 015 A	500	9019150000
H2.5/14D	2.50	14	14.0	8.0	2.2	4.2	0.15	0.25	10.0	● blue	T 20A 016 A	500	9019160000
H2.5/18D	2.50	14	18.0	12.0	2.2	4.2	0.15	0.25	14.0	● blue	T 20A 017 A	500	9019170000
H2.5/24D	2.50	14	24.0	18.0	2.2	4.2	0.15	0.25	20.0	● blue	T 20A 018 A	500	9019180000
H4.0/17D	4.00	12	17.0	10.0	2.8	4.8	0.2	0.3	12.0	● grey	T 20A 019 A	500	9019190000
H4.0/20D	4.00	12	20.0	12.0	2.8	4.8	0.2	0.3	14.0	● grey	T 20A 020 A	500	9019200000
H4.0/26D	4.00	12	26.0	18.0	2.8	4.8	0.2	0.3	20.0	● grey	T 20A 021 A	100	9019210000
H6.0/20D	6.00	10	20.0	12.0	3.5	6.3	0.2	0.3	14.0	● yellow	T 20A 022 A	100	9019220000
H6.0/26D	6.00	10	26.0	18.0	3.5	6.3	0.2	0.3	20.0	● yellow	T 20A 023 A	100	9019230000
H10.0/22D	10.00	7	22.0	12.0	4.5	7.6	0.2	0.4	15.0	● red	T 20A 024 A	100	9019240000
H10.0/28D	10.00	7	28.0	18.0	4.5	7.6	0.2	0.4	21.0	● red	T 20A 025 A	100	9019250000
H16.0/24D	16.00	6	24.0	12.0	5.8	8.8	0.2	0.4	15.0	● blue	T 20A 026 A	100	9019260000
H16.0/28D	16.00	6	28.0	18.0	5.8	8.8	0.2	0.4	21.0	● blue	T 20A 027 A	100	9019270000
H25.0/30D	25.00	3	30.0	16.0	7.3	11.2	0.2	0.4	18.0	● yellow	T 20A 028 A	50	9019280000
H25.0/36D	25.00	3	36.0	22.0	7.3	11.2	0.2	0.4	24.0	● yellow	T 20A 030 A	50	9019300000
H35.0/30D	35.00	2	30.0	18.0	8.3	12.7	0.2	0.4	21.0	● red	T 20A 032 A	50	9019320000
H35.0/30D	35.00	2	30.0	16.0	8.3	12.7	0.2	0.4	19.0	● red	T 20A 031 A	50	9019310000
H35.0/39D	35.00	2	39.0	25.0	8.3	12.7	0.2	0.4	28.0	● red	T 20A 033 A	50	9019330000
H50.0/36D	50.00	1	36.0	20.0	10.3	15.0	0.3	0.5	26.0	● blue	T 20A 034 A	50	9019340000
H50.0/40D	50.00	1	40.0	25.0	10.3	15.0	0.3	0.5	31.0	● blue	T 20A 035 A	50	9019350000

DIN colour code

in multipack bag

Ordering data

Type	ø mm ²	AWG	L1	L2	D1	D2	S1	S2	Stripping length	Colour	VG*	Qty.	Order No.
H0.5/14D	0.50	20	14.0	8.0	1.0	2.6	0.15	0.25	10.0	○ white	T 20A 002 A	500	9019400000
H0.75/14D	0.75	18	14.0	8.0	1.2	2.8	0.15	0.25	10.0	● grey	T 20A 005 A	500	9019410000
H1.0/14D	1.00	17	14.0	8.0	1.4	3.0	0.15	0.25	10.0	● red	T 20A 009 A	500	9019420000
H1.5/14D	1.50	16	14.0	8.0	1.7	3.5	0.15	0.25	10.0	● black	T 20A 012 A	500	9019430000
H1.5/24D	1.50	16	24.0	18.0	1.7	3.5	0.15	0.25	20.0	● black	T 20A 015 A	500	9004140000
H2.5/14	2.50	14	14.0	8.0	2.2	4.2	0.15	0.25	10.0	● blue		500	9026100000
H4.0/17	4.00	12	17.0	10.0	2.8	4.8	0.2	0.3	12.0	● grey		250	9026010000

DIN colour code

Strip of wire end ferrules

Ordering data

Type	ø mm ²	AWG	L1	L2	D1	D2	S1	S2	Stripping length	Colour	VG*	Qty.	Order No.
H0.5/14D	0.50	20	14.0	8.0	1.0	2.6	0.15	0.25	10.0	○ white	T 20A 002 A	500	9004280000
H0.75/14D	0.75	18	14.0	8.0	1.2	2.8	0.15	0.25	10.0	● grey	T 20A 005 A	500	9004300000
H1.0/14D	1.00	17	14.0	8.0	1.4	3.0	0.15	0.25	10.0	● red	T 20A 009 A	500	9004330000
H1.5/14D	1.50	16	14.0	8.0	1.7	3.2	0.15	0.25	10.0	● black	T 20A 012 A	500	9004350000
H2.5/14D	2.50	14	14.0	8.0	2.2	4.0	0.15	0.25	11.0	● blue	T 20A 016 A	500	9004360000

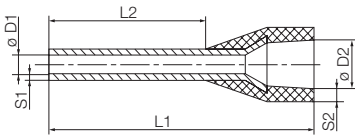

- Polypropylene conical cable entry
- Heat-resistant up to 105 °C
- Cable entry made from a not readily flammable material on request

For conductors from 0.5 to 2.5 mm² (AWG 20-14)
 Tin-plated copper
 Dimensional tolerances to DIN 46228 part 4

DIN colour code

Reel of wire end ferrules

Ordering data

Type	ø mm ²	AWG	L1	L2	D1	D2	S1	S2	Stripping length	Colour	VG*	Qty.	Order No.
H0.5/14D	0.50	20	14.0	8.0	1.0	2.6	0.15	0.25	10.0	○ white		5000	9005860000
H0.75/14	0.75	18	14.0	8.0	1.2	2.8	0.15	0.25	10.0	● grey		5000	9005870000
H1.0/14D	1.00	17	14.0	8.0	1.4	3.0	0.15	0.25	11.0	● red		5000	9005880000
H1.5/14D	1.50	16	14.0	8.0	1.7	3.2	0.15	0.25	10.0	● black		5000	9005890000
H2.5/14D	2.50	14	14.0	8.0	2.2	4.0	0.15	0.25	11.0	● blue		3000	9005850000

Wire end ferrules with plastic collar

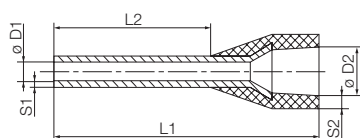

- Polypropylene conical cable entry
- Heat-resistant up to 105 °C
- Cable entry made from a not readily flammable material on request

For conductors from 0.14 to 25 mm² (AWG 26-3)

Tin-plated copper

Dimensional tolerances to DIN 46228 part 4

other colour code

packed loose

Ordering data

Type	ø mm ²	AWG	L1	L2	D1	D2	S1	S2	Stripping length	Colour	Qty.	Order No.
H0.25/10T	0.25	24	10.0	6.0	0.8	1.8	0.15	0.25	8.0	● yellow	500	9021010000
H0.25/12T	0.25	24	12.0	8.0	0.8	1.8	0.15	0.25	10.0	● yellow	500	9021020000
H0.5/12D	0.50	20	12.0	6.0	1.0	2.6	0.15	0.25	8.0	○ white	500	9019000000
H0.5/14D	0.50	20	14.0	8.0	1.0	2.6	0.15	0.25	10.0	○ white	500	9019010000
H0.5/16D	0.50	20	16.0	10.0	1.0	2.6	0.15	0.25	12.0	○ white	500	9019020000
H0.75/12T	0.75	18	12.0	6.0	1.2	2.8	0.15	0.25	8.0	● light blue	500	9021030000
H0.75/14	0.75	18	14.0	8.0	1.2	2.8	0.15	0.25	10.0	● light blue	500	9021040000
H0.75/16T	0.75	18	16.0	10.0	1.2	2.8	0.15	0.25	12.0	● light blue	500	9021050000
H0.75/18T	0.75	18	18.0	12.0	1.2	2.8	0.15	0.25	14.0	● light blue	500	9021060000
H1.0/12D	1.00	17	12.0	6.0	1.4	3.0	0.15	0.25	8.0	● red	500	9019070000
H1.0/14D	1.00	17	14.0	8.0	1.4	3.0	0.15	0.25	10.0	● red	500	9019080000
H1.0/16D	1.00	17	16.0	10.0	1.4	3.0	0.15	0.25	12.0	● red	500	9019100000
H1.0/18D	1.00	17	18.0	12.0	1.4	3.0	0.15	0.25	15.0	● red	500	9019110000
H1.5/14D	1.50	16	14.0	8.0	1.7	3.5	0.15	0.25	10.0	● black	500	9019120000
H1.5/16D	1.50	16	16.0	10.0	1.7	3.5	0.15	0.25	12.0	● black	500	9019130000
H1.5/18D	1.50	16	18.0	12.0	1.7	3.5	0.15	0.25	15.0	● black	500	9019140000
H1.5/24D	1.50	16	24.0	18.0	1.7	3.5	0.15	0.25	20.0	● black	500	9019150000
H2.5/14T	2.50	14	14.0	8.0	2.2	4.2	0.15	0.25	10.0	● grey	500	9021070000
H2.5/18T	2.50	14	18.0	12.0	2.2	4.2	0.15	0.25	14.0	● grey	500	9021080000
H2.5/24T	2.50	14	24.0	18.0	2.2	4.2	0.15	0.25	20.0	● grey	500	9021090000
H4.0/17T	4.00	12	17.0	10.0	2.8	4.8	0.2	0.3	12.0	● orange	500	9021100000
H4.0/20T	4.00	12	20.0	12.0	2.8	4.8	0.2	0.3	14.0	● orange	500	9021110000
H4.0/26T	4.00	12	26.0	18.0	2.8	4.8	0.2	0.3	20.0	● orange	100	9021120000
H6.0/20T	6.00	10	20.0	12.0	3.5	6.3	0.2	0.3	14.0	● green	100	9021130000
H6.0/26T	6.00	10	26.0	18.0	3.5	6.3	0.2	0.3	20.0	● green	100	9021140000
H10.0/22T	10.00	7	22.0	12.0	4.5	7.6	0.2	0.4	15.0	● brown	100	9021150000
H10.0/28T	10.00	7	28.0	18.0	4.5	7.6	0.2	0.4	21.0	● brown	100	9021160000
H16.0/24T	16.00	6	24.0	12.0	5.8	8.8	0.2	0.4	15.0	○ white	100	9021170000
H16.0/28T	16.00	6	28.0	18.0	5.8	8.8	0.2	0.4	21.0	○ white	100	9021180000
H25.0/30T	25.00	3	30.0	16.0	7.3	11.2	0.2	0.4	18.0	● black	50	9021190000
H25.0/36T	25.00	3	36.0	22.0	7.3	11.2	0.2	0.4	24.0	● black	50	9021200000

other colour code

in multipack bag

Ordering data

Type	ø mm ²	AWG	L1	L2	D1	D2	S1	S2	Stripping length	Colour	Qty.	Order No.
H0.14/10T	0.14	26	10.0	6.0	0.6	1.5	0.15	0.25	8.0	● brown	500	9028250000
H0.25/10T	0.25	24	10.0	6.0	0.8	1.8	0.15	0.25	8.0	● yellow	500	9021210000
H0.25/12T	0.25	24	12.0	8.0	0.8	1.8	0.15	0.25	10.0	● yellow	500	9021220000
H0.5/14D	0.50	20	14.0	8.0	1.0	2.6	0.15	0.25	10.0	○ white	500	9019400000
H0.75/14T	0.75	18	14.0	8.0	1.2	2.8	0.15	0.25	10.0	● light blue	500	9021230000
H1.0/14D	1.00	17	14.0	8.0	1.4	3.0	0.15	0.25	10.0	● red	500	9019420000
H1.5/14D	1.50	16	14.0	8.0	1.7	3.5	0.15	0.25	10.0	● black	500	9019430000
H1.5/24D	1.50	16	24.0	18.0	1.7	3.5	0.15	0.25	20.0	● black	500	9004140000
H2.5/14T	2.50	14	14.0	8.0	2.2	4.2	0.15	0.25	10.0	● grey	500	9021240000
H4.0/17T	4.00	12	17.0	10.0	2.8	4.8	0.2	0.3	12.0	● orange	250	9021250000

other colour code

Strip of wire end ferrules

Ordering data

Type	ø mm ²	AWG	L1	L2	D1	D2	S1	S2	Stripping length	Colour	Qty.	Order No.
H0.5/14D	0.50	20	14.0	8.0	1.0	2.6	0.15	0.25	10.0	○ white	500	9004280000
H0.75/14T	0.75	18	14.0	8.0	1.2	2.8	0.15	0.25	10.0	● light blue	500	9004310000
H1.0/14D	1.00	17	14.0	8.0	1.4	3.0	0.15	0.25	10.0	● red	500	9004330000
H1.5/14D	1.50	16	14.0	8.0	1.7	3.2	0.15	0.25	10.0	● black	500	9004350000
H2.5/14T	2.50	14	14.0	8.0	2.2	4.0	0.15	0.25	11.0	● grey	500	9004370000

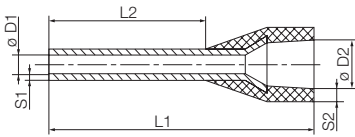

- Polypropylene conical cable entry
- Heat-resistant up to 105 °C
- Cable entry made from a not readily flammable material on request

For conductors from 0.5 to 2.5 mm² (AWG 20-14)
 Tin-plated copper
 Dimensional tolerances to DIN 46228 part 4

other colour code

Reel of wire end ferrules

Ordering data

Type	ø mm ²	AWG	L1	L2	D1	D2	S1	S2	Stripping length	Colour	Qty.	Order No.
H0.5/14D	0.50	20	14.0	8.0	1.0	2.6	0.15	0.25	10.0	○ white	5000	9005860000
H0.75/14T	0.75	18	14.0	8.0	1.2	2.8	0.15	0.25	10.0	● light blue	5000	9005900000
H1.0/14D	1.00	17	14.0	8.0	1.4	3.0	0.15	0.25	11.0	● red	5000	9005880000
H1.5/14D	1.50	16	14.0	8.0	1.7	3.2	0.15	0.25	10.0	● black	5000	9005890000
H2.5/14T	2.50	14	14.0	8.0	2.2	4.0	0.15	0.25	11.0	● grey	3000	9005910000

Twin-wire end ferrules with plastic collar

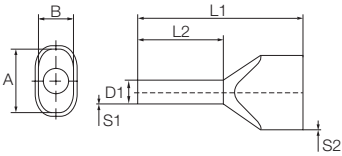

- Polypropylene conical cable entry
- Heat-resistant up to 105 °C
- Cable entry made from a not readily flammable material on request

For conductors from 2 x 0,5-2 x 16 mm² (2 x AWG 20-2 x AWG 6)
Tin-plated copper
Dimensional tolerances to DIN 46228 part 4

Weidmüller colour code

packed loose

Ordering data

Type	ø mm ²	AWG	L1	L2	D1	D2	S1	S2	Stripping length	Colour	Qty.	Order No.
H0.5/15	0.50	20	15.0	8.0	1.4		0.15	0.3	11.0	● orange	500	9037200000
H0.5/16.5	0.50	20	16.0	10.0	1.4		0.15	0.3	13.0	● orange	500	9037210000
H0.5/18.5	0.50	20	19.0	12.0	1.4		0.15	0.3	15.0	● orange	500	9037220000
H0.75/15	0.75	18	15.0	8.0	1.7		0.15	0.3	11.0	○ white	500	9037230000
H0.75/17	0.75	18	17.0	10.0	1.7		0.15	0.3	13.0	○ white	500	9037240000
H0.75/19S	0.75	18	19.0	12.0	1.4		0.15	0.3	21.0	○ white	500	9202820000
H0.75/24.5	0.75	18	24.0	18.0	1.7		0.15	0.3	21.0	○ white	500	9037250000
H1.0/15	1.00	17	15.0	8.0	2.0		0.15	0.3	12.0	● yellow	500	9037260000
H1.0/15S	1.00	17	16.0	8.0	2.2		0.15	0.3	12.0	● yellow	500	9018690000
H1.0/20	1.00	17	19.0	12.0	2.0		0.15	0.3	16.0	● yellow	500	9037270000
H1.0/25.6	1.00	17	25.0	18.0	2.0		0.15	0.3	22.0	● yellow	500	9037280000
H1.5/16	1.50	16	16.0	8.2	2.2		0.15	0.3	11.0	● red	500	9037290000
H1.5/20	1.50	16	20.0	12.0	2.2		0.15	0.3	15.0	● red	500	9037300000
H1.5/25.6	1.50	16	26.0	18.0	2.2		0.15	0.3	21.0	● red	100	9037310000
H2.5/18.5D	2.50	14	19.0	10.0	2.8		0.15	0.4	13.0	● blue	500	9037500000
H2.5/20.5D	2.50	14	21.0	12.0	2.8		0.15	0.4	15.0	● blue	100	9037510000
H2.5/26.5D	2.50	14	27.0	18.0	2.8		0.15	0.4	21.0	● blue	100	9037520000
H4.0/22D	4.00	12	22.0	12.0	3.5		0.2	0.5	15.0	● grey	100	9037530000
H4.0/28D	4.00	12	28.0	18.0	3.5		0.2	0.5	21.0	● grey	100	9037540000
H6.0/25	6.00	10	25.0	12.0	4.5		0.2	0.5	20.0	● black	100	9037320000
H6.0/29	6.00	10	29.0	18.0	4.5		0.2	0.5	24.0	● black	100	9037330000
H10.0/24S	10.00	7	24.0	12.0	6.5		0.2	0.5	17.0	● ivory	100	9018860000
H10.0/26	10.00	7	24.0	12.0	5.8		0.2	0.5	17.0	● ivory	100	9037340000
H10.0/30	10.00	7	30.0	18.0	5.8		0.2	0.5	23.0	● ivory	100	9037350000
H10.0/30S	10.00	7	30.0	18.0	6.5		0.2	0.5	23.0	● ivory	100	9018870000
H16.0/29	16.00	6	29.0	16.0	8.3		0.3	0.6	20.0	● green	50	9037360000
H16.0/38	16.00	6	38.0	25.0	8.3		0.3	0.6	29.0	● green	50	9037370000

Weidmüller colour code

in multipack bag

Ordering data

Type	ø mm ²	AWG	L1	L2	D1	D2	S1	S2	Stripping length	Colour	Qty.	Order No.
H0.5/15	0.50	20	15.0	8.0	1.4		0.15	0.3	11.0	● orange	500	9004440000
H0.75/15	0.75	18	15.0	8.0	1.7		0.15	0.3	11.0	○ white	500	9018510000
H0.75/17	0.75	18	17.0	10.0	1.7		0.15	0.3	13.0	○ white	500	9004900000
H1.0/15	1.00	17	15.0	8.0	2.0		0.15	0.3	12.0	● yellow	500	9018530000
H1.0/15S	1.00	17	16.0	8.0	2.2		0.15	0.3	12.0	● yellow	500	9018650000
H1.0/20	1.00	17	19.0	12.0	2.0		0.15	0.3	16.0	● yellow	500	9004910000
H1.5/16	1.50	16	16.0	8.2	2.2		0.15	0.3	11.0	● red	500	9004410000
H1.5/20	1.50	16	20.0	12.0	2.2		0.15	0.3	15.0	● red	500	9004920000
H2.5/18.5D	2.50	14	19.0	10.0	2.8		0.15	0.4	13.0	● blue	250	9004430000
H2.5/20.5D	2.50	14	21.0	12.0	2.8		0.15	0.4	15.0	● blue	250	9004740000
H4.0/22D	4.00	12	22.0	12.0	3.5		0.2	0.5	15.0	● grey	100	9004730000
H6.0/25	6.00	10	25.0	12.0	4.5		0.2	0.5	20.0	● black	100	9004930000
H10.0/26	10.00	7	24.0	12.0	5.8		0.2	0.5	17.0	● ivory	100	9004940000

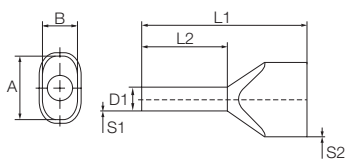

- Polypropylene conical cable entry
- Heat-resistant up to 105 °C
- Cable entry made from a not readily flammable material on request

For conductors from 2 x 0,5-2 x 16 mm² (2 x AWG 20-2 x AWG 6)
 Tin-plated copper
 Dimensional tolerances to DIN 46228 part 4

DIN colour code

packed loose

Ordering data

Type	ø mm ²	AWG	L1	L2	D1	D2	S1	S2	Stripping length	Colour	Qty.	Order No.
H0.5/15D	0.50	20	15.0	8.0	1.4		0.15	0.3	11.0	○ white	500	9037380000
H0.5/16.5D	0.50	20	16.0	10.0	1.4		0.15	0.3	13.0	○ white	500	9037390000
H0.5/18.4D	0.50	20	19.0	12.0	1.4		0.15	0.3	15.0	○ white	500	9037400000
H0.75/15D	0.75	18	15.0	8.0	1.7		0.15	0.3	11.0	● grey	500	9037410000
H0.75/17D	0.75	18	17.0	10.0	1.7		0.15	0.3	13.0	● grey	500	9037420000
H0.75/19DS	0.75	18	19.0	12.0	1.4		0.15	0.3	21.0	● grey	500	9202830000
H0.75/24.5D	0.75	18	24.0	18.0	1.7		0.15	0.3	21.0	● grey	500	9037430000
H1.0/15D	1.00	17	16.0	8.0	2.2		0.15	0.3	12.0	● red	500	9037440000
H1.0/20D	1.00	17	19.0	12.0	2.0		0.15	0.3	16.0	● red	500	9037450000
H1.0/25.6D	1.00	17	25.0	18.0	2.0		0.15	0.3	22.0	● red	500	9037460000
H1.5/16D	1.50	16	16.0	8.0	2.2		0.15	0.3	11.0	● black	500	9037470000
H1.5/20D	1.50	16	20.0	12.0	2.2		0.15	0.3	15.0	● black	500	9037480000
H1.5/25.6D	1.50	16	26.0	18.0	2.2		0.15	0.3	21.0	● black	100	9037490000
H2.5/18.5D	2.50	14	19.0	10.0	2.8		0.15	0.4	13.0	● blue	500	9037500000
H2.5/20.5D	2.50	14	21.0	12.0	2.8		0.15	0.4	15.0	● blue	100	9037510000
H2.5/26.5D	2.50	14	27.0	18.0	2.8		0.15	0.4	21.0	● blue	100	9037520000
H4.0/22D	4.00	12	22.0	12.0	3.5		0.2	0.5	15.0	● grey	100	9037530000
H4.0/28D	4.00	12	28.0	18.0	3.5		0.2	0.5	21.0	● grey	100	9037540000
H6.0/25D	6.00	10	25.0	12.0	4.5		0.2	0.5	20.0	● yellow	100	9037550000
H6.0/29D	6.00	10	29.0	18.0	4.5		0.2	0.5	24.0	● yellow	100	9037560000
H10.0/24DS	10.00	7	24.0	12.0	6.5		0.2	0.5	17.0	● red	100	9018880000
H10.0/26D	10.00	7	24.0	12.0	5.8		0.2	0.5	17.0	● red	100	9037570000
H10.0/30D	10.00	7	30.0	18.0	5.8		0.2	0.5	23.0	● red	100	9037580000
H10.0/30DS	10.00	7	30.0	18.0	6.5		0.2	0.5	23.0	● red	100	9018890000
H16.0/29D	16.00	6	29.0	16.0	8.3		0.3	0.6	20.0	● blue	50	9037590000
H16.0/38D	16.00	6	38.0	25.0	8.3		0.3	0.6	29.0	● blue	50	9037600000

DIN colour code

in multipack bag

Ordering data

Type	ø mm ²	AWG	L1	L2	D1	D2	S1	S2	Stripping length	Colour	Qty.	Order No.
H0.5/15D	0.50	20	15.0	8.0	1.4		0.15	0.3	11.0	○ white	500	9004780000
H0.75/15D	0.75	18	15.0	8.0	1.7		0.15	0.3	11.0	● grey	500	9018520000
H0.75/17D	0.75	18	17.0	10.0	1.7		0.15	0.3	13.0	● grey	500	9004770000
H1.0/15D	1.00	17	16.0	8.0	2.2		0.15	0.3	12.0	● red	500	9018540000
H1.0/20D	1.00	17	19.0	12.0	2.0		0.15	0.3	16.0	● red	500	9004760000
H1.5/16D	1.50	16	16.0	8.0	2.2		0.15	0.3	11.0	● black	500	9004420000
H1.5/20D	1.50	16	20.0	12.0	2.2		0.15	0.3	15.0	● black	500	9004750000
H2.5/18.5D	2.50	14	19.0	10.0	2.8		0.15	0.4	13.0	● blue	250	9004430000
H2.5/20.5D	2.50	14	21.0	12.0	2.8		0.15	0.4	15.0	● blue	250	9004740000
H4.0/22D	4.00	12	22.0	12.0	3.5		0.2	0.5	15.0	● grey	100	9004730000
H6.0/25D	6.00	10	25.0	12.0	4.5		0.2	0.5	20.0	● yellow	100	9004720000
H10.0/26D	10.00	7	24.0	12.0	5.8		0.2	0.5	17.0	● red	100	9004710000

Twin-wire end ferrules with plastic collar

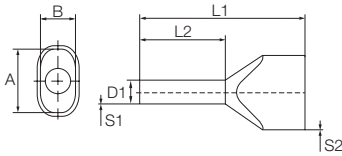

- Polypropylene conical cable entry
- Heat-resistant up to 105 °C
- Cable entry made from a not readily flammable material on request

For conductors from 2 x 0,5-2 x 16 mm² (2 x AWG 20-2 x AWG 6)
Tin-plated copper
Dimensional tolerances to DIN 46228 part 4

other colour code

packed loose

Ordering data

Type	ø mm ²	AWG	L1	L2	D1	D2	S1	S2	Stripping length	Colour	Qty.	Order No.
H0.5/15	0.50	20	15.0	8.0	1.4		0.15	0.3	11.0	● orange	500	9037200000
H0.5/16.5	0.50	20	16.0	10.0	1.4		0.15	0.3	13.0	● orange	500	9037210000
H0.5/18.5	0.50	20	19.0	12.0	1.4		0.15	0.3	15.0	● orange	500	9037220000
H0.75/15T	0.75	18	15.0	8.0	1.7		0.15	0.3	11.0	● light blue	500	9037610000
H0.75/17T	0.75	18	17.0	10.0	1.7		0.15	0.3	13.0	● light blue	500	9037620000
H0.75/19TS	0.75	18	19.0	12.0	1.4		0.15	0.3	21.0	● light blue	500	9202840000
H0.75/24.5T	0.75	18	24.0	18.0	1.7		0.15	0.3	21.0	● light blue	500	9037630000
H1.0/15D	1.00	17	16.0	8.0	2.2		0.15	0.3	12.0	● red	500	9037440000
H1.0/20D	1.00	17	19.0	12.0	2.0		0.15	0.3	16.0	● red	500	9037450000
H1.0/25.6D	1.00	17	25.0	18.0	2.0		0.15	0.3	22.0	● red	500	9037460000
H1.5/16D	1.50	16	16.0	8.0	2.2		0.15	0.3	11.0	● black	500	9037470000
H1.5/20D	1.50	16	20.0	12.0	2.2		0.15	0.3	15.0	● black	500	9037480000
H1.5/25.6D	1.50	16	26.0	18.0	2.2		0.15	0.3	21.0	● black	100	9037490000
H2.5/18.5T	2.50	14	19.0	10.0	2.8		0.15	0.4	13.0	● grey	500	9037640000
H2.5/20.5T	2.50	14	21.0	12.0	2.8		0.15	0.4	15.0	● grey	100	9037650000
H2.5/26.5T	2.50	14	27.0	18.0	2.8		0.15	0.4	21.0	● grey	100	9037660000
H4.0/22T	4.00	12	22.0	12.0	3.5		0.2	0.5	15.0	● orange	100	9037670000
H4.0/28T	4.00	12	28.0	18.0	3.5		0.2	0.5	21.0	● orange	100	9037680000
H6.0/25T	6.00	10	25.0	12.0	4.5		0.2	0.5	20.0	● green	100	9037690000
H6.0/29T	6.00	10	29.0	18.0	4.5		0.2	0.5	24.0	● green	100	9037700000
H10.0/26T	10.00	7	24.0	12.0	5.8		0.2	0.5	17.0	● brown	100	9037710000
H10.0/30T	10.00	7	30.0	18.0	5.8		0.2	0.5	23.0	● brown	100	9037720000
H16.0/19T	16.00	6	29.0	16.0	8.3		0.3	0.6	20.0	○ white	50	9037730000
H16.0/38T	16.00	6	38.0	25.0	8.3		0.3	0.6	29.0	○ white	50	9037740000

other colour code

in multipack bag

Ordering data

Type	ø mm ²	AWG	L1	L2	D1	D2	S1	S2	Stripping length	Colour	Qty.	Order No.
H0.75/17T	0.75	18	17.0	10.0	1.7		0.15	0.3	13.0	● light blue	500	9005140000
H1.0/15D	1.00	17	16.0	8.0	2.2		0.15	0.3	12.0	● red	500	9018540000
H1.0/20D	1.00	17	19.0	12.0	2.0		0.15	0.3	16.0	● red	500	9004760000
H1.5/16D	1.50	16	16.0	8.0	2.2		0.15	0.3	11.0	● black	500	9004420000
H1.5/20D	1.50	16	20.0	12.0	2.2		0.15	0.3	15.0	● black	500	9004750000
H2.5/18.5T	2.50	14	19.0	10.0	2.8		0.15	0.4	13.0	● grey	250	9018580000
H2.5/20.5	2.50	14	21.0	12.0	2.8		0.15	0.4	15.0	● grey	250	9005150000
H4.0/22T	4.00	12	22.0	12.0	3.5		0.2	0.5	15.0	● orange	100	9018590000
H6.0/25T	6.00	10	25.0	12.0	4.5		0.2	0.5	20.0	● green	100	9005160000
H10.0/26T	10.00	7	24.0	12.0	5.8		0.2	0.5	17.0	● brown	100	9005170000

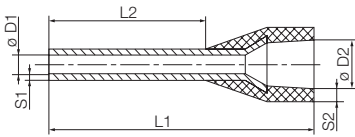

- Polypropylene conical cable entry
- Heat-resistant up to 105 °C
- Cable entry made from a not readily flammable material on request

For conductors from 1.5 to 16 mm² (AWG 16-6)
 Tin-plated copper
 Dimensional tolerances to DIN 46228 part 4

Weidmüller colour code

packed loose

Ordering data

Type	ø mm ²	AWG	L1	L2	D1	D2	S1	S2	Stripping length	Colour	Qty.	Order No.
H1.5/24 XS	1.50	16	24.0	18.0	1.8	6.8	0.15	0.3	20.0	● black	100	9202870000
H2.5/24 XS	2.50	14	24.0	18.0	2.3	7.6	0.15	0.3	20.0	● blue	100	9202880000

Weidmüller colour code

in multipack bag

Ordering data

Type	ø mm ²	AWG	L1	L2	D1	D2	S1	S2	Stripping length	Colour	Qty.	Order No.
H1.5/17.5X	1.50	16	17.5	8.0	1.8	6.8	0.15	0.3	13.0	● black	100	9006590000
H1.5/19.5X	1.50	16	19.5	10.0	1.8	6.8	0.15	0.3	15.0	● black	100	9006630000
H2.5/17.5X	2.50	14	17.5	8.0	2.3	7.6	0.15	0.3	14.0	● blue	100	9006670000
H2.5/21.5X	2.50	14	21.5	12.0	2.3	7.6	0.15	0.3	17.0	● blue	100	9006710000
H4.0/19.5X	4.00	12	19.5	10.0	2.9	7.8	0.2	0.3	14.0	● grey	100	9006750000
H6.0/23.0X	6.00	10	23.0	12.0	3.6	8.1	0.2	0.3	17.0	● yellow	100	9006790000
H10.0/24.5X	10.00	7	24.0	12.0	4.6	9.6	0.2	0.3	17.0	● red	100	9006830000
H16.0/25.5X	16.00	6	25.5	12.0	6.0	11.9	0.2	0.3	26.0	● blue	100	9006870000

Wire end ferrules with plastic collar, special sizes

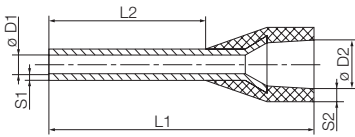

- Polypropylene conical cable entry
- Heat-resistant up to 105 °C
- Cable entry made from a not readily flammable material on request

For conductors from 0.5 to 2.5 mm² (AWG 20-14)
Tin-plated copper
Dimensional tolerances to DIN 46228 part 4

Weidmüller colour code

packed loose

Ordering data

Type	ø mm ²	AWG	L1	L2	D1	D2	S1	S2	Stripping length	Colour	Qty.	Order No.
H0.5/14S	0.50	20	14.0	8.0	1.0	2.9	0.15	0.25	10.0	● orange	500	9004560000
H0.5/14S	0.50	20	14.0	8.0	1.0	2.9	0.15	0.25	10.0	○ white	500	9004590000
H0.5/16DS	0.50	20	16.0	10.0	1.0	2.9	0.15	0.25	12.0	○ white	500	9202910000
H0.5/16S	0.50	20	16.0	10.0	1.0	2.9	0.15	0.25	12.0	● orange	500	9202900000
H0.75/14S	0.75	18	14.0	8.0	1.2	3.4	0.15	0.25	10.0	○ white	500	9025960000
H0.75/14TS	0.75	18	14.0	8.0	1.2	3.4	0.15	0.25	10.0	● light blue	500	9018550000
H1.0/14S	1.00	17	14.0	8.0	1.4	3.5	0.15	0.25	10.0	● yellow	500	9025970000
H1.0/14S	1.00	17	14.0	8.0	1.4	3.5	0.15	0.25	10.0	● red	500	9018560000
H1.5/12S	1.50	16	12.0	6.0	1.7	3.5	0.15	0.25	8.0	● red	500	9025690000
H1.5/14S	1.50	16	14.0	8.0	1.7	3.9	0.15	0.25	10.0	● red	500	9025980000
H1.5/14S	1.50	16	14.0	8.0	1.7	3.9	0.15	0.25	10.0	● black	500	9025240000
H2.5/12DS	2.50	14	12.0	6.0	2.2	4.2	0.15	0.25	8.0	● blue	500	9028490000
H2.5/12TS	2.50	14	12.0	6.0	2.2	4.2	0.15	0.25	8.0	● grey	500	9036200000
H2.5/14S	2.50	14	14.0	8.0	2.2	4.0	0.15	0.25	10.0	● blue	500	1333100000
H2.5/14TS	2.50	14	14.0	8.0	2.2	4.0	0.15	0.25	10.0	● grey	500	9426770000
H2.5/16DS	2.50	14	16.0	10.0	2.2	4.2	0.15	0.25	13.0	● blue	500	9036220000

Weidmüller colour code

in multipack bag

Ordering data

Type	ø mm ²	AWG	L1	L2	D1	D2	S1	S2	Stripping length	Colour	Qty.	Order No.
H0.75/14S	0.75	18	14.0	8.0	1.2	3.4	0.15	0.25	10.0	○ white	500	9025700000
H1.0/14S	1.00	17	14.0	8.0	1.4	3.5	0.15	0.25	10.0	● yellow	500	9025710000
H1.5/14DS	1.50	16	14.0	8.0	1.7	3.9	0.15	0.25	10.0	● black	500	9028360000
H1.5/14S	1.50	16	14.0	8.0	1.7	3.9	0.15	0.25	10.0	● red	500	9025720000

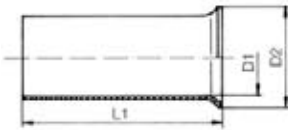

For conductors 0.25-185 mm² (AWG 24-350MCM)
 Material: tin-plated copper
 Dimensional tolerances to DIN 46228 part 1

without plastic collar

packed loose

Ordering data

Type	ø mm ²	AWG	L1	L2	D1	D2	S1	S2	Stripping length	Colour	Qty.	Order No.
H0.25/5	0.25	24	5.0		0.7	1.6			5.0		1000	9018910000
H0.5/10	0.50	20	10.0		1.0	2.1			10.0		1000	9004050000
H0.5/6	0.50	20	6.0		1.0	2.1			6.0		1000	0282600000
H0.75/10	0.75	18	10.0		1.2	2.3			10.0		1000	0542500000
H0.75/6	0.75	18	6.0		1.2	2.3			6.0		1000	0282700000
H1.0/10	1.00	17	10.0		1.4	2.5			10.0		1000	0282800000
H1.0/6	1.00	17	6.0		1.4	2.5			6.0		1000	0372600000
H1.5/7	1.50	16	7.0		1.7	2.8			7.0		1000	0372700000
H1.5/10	1.50	16	10.0		1.7	2.8			10.0		1000	0186500000
H1.5/12	1.50	16	12.0		1.7	2.8			12.0		1000	9004060000
H1.5/18	1.50	16	18.0		1.7	2.8			18.0		1000	9004070000
H2.5/7	2.50	14	7.0		2.2	3.4			7.0		1000	0373000000
H2.5/10	2.50	14	10.0		2.2	3.4			10.0		1000	9004080000
H2.5/12	2.50	14	12.0		2.2	3.4			12.0		1000	0186100000
H2.5/18	2.50	14	18.0		2.2	3.4			18.0		1000	9004090000
H4.0/9	4.00	12	9.0		2.8	4.0			9.0		500	0373100000
H4.0/15	4.00	12	15.0		2.8	4.0			15.0		500	9004100000
H4.0/12	4.00	12	12.0		2.8	4.0			12.0		1000	0244100000
H4.0/18	4.00	12	18.0		2.8	4.0			18.0		500	9004110000
H6.0/10	6.00	10	10.0		3.5	4.7			10.0		500	9004120000
H6.0/12	6.00	10	12.0		3.5	4.7			12.0		500	0191900000
H6.0/15	6.00	10	15.0		3.5	4.7			15.0		500	0124700000
H6.0/18	6.00	10	18.0		3.5	4.7			18.0		500	9004130000
H10.0/12	10.00	7	12.0		4.5	5.8			12.0		500	0282900000
H10.0/15	10.00	7	15.0		4.5	5.8			15.0		500	0124800000
H10.0/18	10.00	7	18.0		4.5	5.8			18.0		500	0379300000
H16.0/12	16.00	6	12.0		5.8	7.5			12.0		500	0492500000
H16.0/15	16.00	6	15.0		5.8	7.5			15.0		500	0124300000
H16.0/18	16.00	6	18.0		5.8	7.5			18.0		100	0375200000
H16.0/25	16.00	6	25.0		5.8	7.5			25.0		100	9004150000
H16.0/32	16.00	6	32.0		5.8	7.5			32.0		100	9004160000
H25.0/15	25.00	3	15.0		7.3	9.5			15.0		250	0124400000
H25.0/18	25.00	3	18.0		7.3	9.5			18.0		100	0375300000
H25.0/25	25.00	3	25.0		7.3	9.5			25.0		250	9004170000
H25.0/32	25.00	3	32.0		7.3	9.5			32.0		100	9004180000
H35.0/18	35.00	2	18.0		8.3	11.0			18.0		100	0368900000
H35.0/25	35.00	2	25.0		8.3	11.0			25.0		100	9004190000
H35.0/30	35.00	2	30.0		8.3	11.0			30.0		100	9451000000
H35.0/32	35.00	2	32.0		8.3	11.0			32.0		100	9004200000
H50.0/18	50.00	1	18.0		10.3	13.0			18.0		100	9004210000
H50.0/25	50.00	1	25.0		10.3	13.0			25.0		100	9025880000
H50.0/32	50.00	1	32.0		10.3	13.0			32.0		100	9004220000
H70.0/25	70.00	2/0	25.0		12.5	15.0			25.0		50	9004230000
H70.0/32	70.00	2/0	32.0		12.5	15.0			32.0		50	9004240000
H95.0/25	95.00	3/0	25.0		14.5	17.0			25.0		50	9004250000
H95.0/32	95.00	3/0	32.0		14.5	17.0			32.0		50	9004260000
H120.0/32	120.00	4/0	32.0		16.5	19.0			32.0		25	9036240000
H150.0/32	150.00	300 MCM	32.0		18.5	21.0			32.0		25	9036250000
H185.0/32	185.00	350 MCM	32.0		20.0	23.5			32.0		25	9036260000

Tools

Tools for insulated cable lugs

Tool	Order No.	0.5 - 1.5	Type of contact 1.5 - 2.5	4.0 - 6.0
CTI 6	9006120000	●	●	●
CTI 6 S	9006210000	●	●	●
HTI 15	9014400000	●	●	●
Station		red	blue	yellow

Crimping tools for ferrules

	PZ 1.5	stripax® plus 2.5	PZ 3	PZ 4	PZ 6 roto	PZ 6 HEX	PZ 6/5	PZ 16	PZ 50
	Order No.								
	9005990000	9020000000	0567300000	9012500000	9014350000	9013650000	9011460000	9012600000	9006450000
Ferrule mm ²									
H 0.25	●				●	●	●		
H 0.34	●				●	●	●		
H 0.5	●	● ¹	●	●	●	●	●		
H 0.75	●	● ¹	●	●	●	●	●		
H 1.0	●	● ¹	●	●	●	●	●		
H 1.5	●	● ¹	●	●	●	●	●		
H 2.5		● ¹	●	●	●	●	●		
H 4.0			●	●	●	●	●		
H 6.0			●		●	●	●	●	
H 10.0								●	
H 16.0								●	
H 25.0									●
H 35.0									●
H 50.0									●

●¹ = ferrules in strip form only

Twin wire end ferrules are to be crimped according to the following table:

Tool	Order No.	H 0.5	H 0.75	H 1.0	H 1.5	Ferrules H 2.5	H 4.0	H 6.0	H 10.0	H 16.0
PZ 1.5	9005990000	●	●							
PZ 3	0567300000	●	●	●	●	●				
PZ 4	9012500000	●	●	●	●	●				
PZ 6 roto	9014350000	●	●	●	●	●	●			
PZ 6/5	9011460000		●	●	●	●	●			
Station		1.5 mm ²	1.5 mm ²	2.5 mm ²	2.5 mm ²	4 mm ²	6 mm ²			
PZ ZH 16	9013600000							●	●	●

Marking systems

Marking systems

Marking systems

Overview terminal markers	K.2
Selection table	K.3
DEK standard printing	K.6
Dekafix	K.10
Introduction - WS	K.12
Introduction - ZS	K.13
WS / ZS	K.14
Tag carrier	K.16
Overview Printing systems	K.20
Laser printer – SMark-Laser	K.21
Inkjet printer – PrintJet PRO	K.22
Plotter – MCP Plus	K.23
Plotter – MC-Mobilo	K.25
Software – M-Print® PRO Label Designer	K.26

Terminal markers

Weidmüller's multitude of different terminal markers enable users to solve virtually every labelling task of all types of wire and cable connectors. Whether multi-character labelling, ready-to-use markers with standard printing or individual, custom markers, whether white or coloured or group designations at terminals, the comprehensive range of Weidmüller products solves every marking task simply, quickly and clearly.

The tables on the following pages show which markers fit the various terminal series. The terminal pitch governs the selection of a marker. For example, a WDU 2.5 terminal has a pitch of 5 mm, the WS 12/5 marker is 12 mm long and suitable for a 5 mm pitch.

Whole blocks of terminals can be marked as a strip using the Weidmüller system. When a terminal with a larger pitch has to be marked (e.g. WDU 16), a smaller marker (e.g. WS 12/5) can be clipped onto it. Most of the markers are compatible with each other.

The two traditional marker series, DEK and WS, are available as ready-to-use markers. And these markers are also available in the MultiCard format for printing by users themselves. MultiCard – the concept for labelling with the SMark Laser, Print-Jet, Plotter or MC-Mobilo.

To see a small selection of the Weidmüller markers, order our bag of samples, order No. **1646670000**.

W series

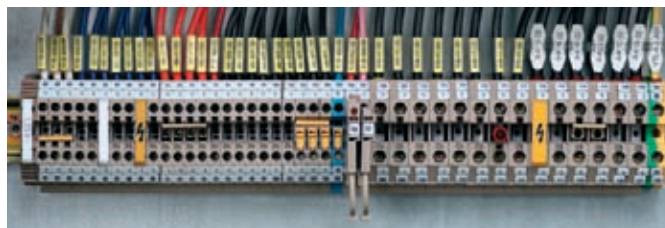

Z series



I series

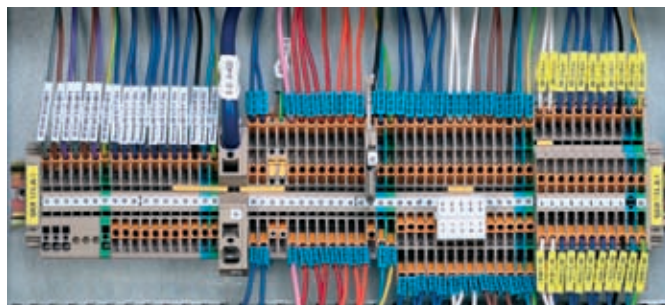

P series



Owing to the sheer number of possible applications and environmental influences such as moisture, radiation, gases or heat/cold to which the products can be exposed, Weidmüller accepts no liability for the suitability of products in all customer applications. Suitability tests for specific applications must therefore be carried out by the customer. However, Weidmüller will be happy to provide help and advice upon request.

Due to the different identification system available on the market, we wish to point out that Weidmüller does not guarantee industrial identification products if the Weidmüller components (markers – transparent sleeves – ink/toner/colour ink ribbons – printing systems) are combined with third-party products, unless Weidmüller has explicitly agreed for the purpose of an individual application.

Designation	Terminal width	DEK	WS	ZS	SchT 7	SchT 9/4	SchT 14/6	WTS 3/4	WGB 5/ WAD 5	WGB 8/ WAD 8	WAD 12	WAD 27	ZGB 15/ ZGB 30	BZT 1	BZT 2	EM 8/30
AKE 2.5/AKZ 2.5...	5	5	-	-	-	-	-	-	-	-	-	-	-	-	-	-
AKZ 1.5...	5	5	-	-	-	-	-	-	-	-	-	-	-	-	-	-
AKZ 4.../AKB 4...	6	6	8/5	-	-	x	-	-	-	-	-	-	-	-	-	-
BZT ZVL 1.5	5.08	5	12/5	-	-	-	-	-	-	-	-	-	-	-	-	-
DLA 2.5...	6	6	8/5	-	x	x	x	-	-	-	-	-	-	-	-	-
DLD 2.5...	6	6	8/5	-	x	x	x	-	-	-	-	-	-	-	-	-
DLI 2.5	6	6	8/5	-	x	x	x	-	-	-	-	-	-	-	-	-
EW 15	9.5	5	12/5	-	x	x	-	x	-	-	-	-	-	-	-	-
EW 15/2	8	5	-	-	-	-	-	-	-	-	-	-	-	-	-	-
EW 35	8.5	5	8/5	-	-	-	-	x	-	-	-	-	-	-	-	-
EWK	8.5	5	8/5	-	-	-	-	-	-	-	-	-	-	-	-	-
EWK 1	8.5	5	8/5	-	-	-	-	x	-	-	-	-	-	-	-	-
EWK 2	8.5	5	8/5	-	-	-	-	-	-	-	-	-	-	-	-	-
IAK 1.5N 3L	5	5	10/5 ²⁾	10/5	-	-	-	-	-	-	-	-	x	-	-	-
IDK 1.5N	5	5	10/5 ²⁾	10/5	-	x ³⁾	-	-	-	-	-	-	-	-	-	-
IDK 1.5N/V	5	5	10/5 ²⁾	10/5	-	-	-	-	-	-	-	-	x	-	-	-
IDU 1.5 N ...	5	5	10/5 ²⁾	10/5	-	-	-	-	-	-	-	-	x	-	-	-
IDU 2.5N...	6	6	10/6 ¹⁾	12/6	-	-	-	-	-	-	-	-	-	-	-	-
IEK 1.5N...	5	5	10/5 ²⁾	10/5	-	-	-	-	-	-	-	-	x	-	-	-
IHK 1.5N...	5	5	10/5 ²⁾	10/5	-	-	-	-	-	-	-	-	x	-	-	-
IPE 1.5N...	5	5	10/5 ²⁾	10/5	-	-	-	-	-	-	-	-	x	-	-	-
IPE 2.5N...	6	6	10/6 ¹⁾	12/6	-	-	-	-	-	-	-	-	-	-	-	-
ITR 1.5N...	5	5	10/5 ²⁾	10/5	-	-	-	-	-	-	-	-	x	-	-	-
ITR 2.5N...	6	6	10/6 ¹⁾	12/6	-	-	-	-	-	-	-	-	-	-	-	-
PTR 2.5/...	5	5	10/5	10/5	-	-	-	-	-	-	-	-	-	-	-	-
MAK 2.5/VLI 1.5...	6	6	8/5	-	x	x	x	-	-	-	-	-	x	-	-	-
WDK 1.5/R 3.5...	3.5	3.5	-	-	-	-	-	-	-	-	-	-	-	-	-	-
WDK 2.5 ...	5	5	8/5	-	-	x	-	-	-	-	-	-	x	-	-	-
WDK 2.5 800V	6	6	8/5	-	-	x	-	-	-	-	-	-	x	-	-	-
WDK 2.5/BLA R5.08	5.08	5	8/5	-	-	-	-	x	-	-	-	-	-	-	-	-
WDK 2.5/BLZ R5.08	5.08	5	8/5	-	-	-	-	x	-	-	-	-	-	-	-	-
WDK 2.5N...	5	5	8/5	-	-	-	-	-	-	-	-	-	-	-	-	-
WDK 4N...	5	5	8/5	-	-	-	-	-	-	-	-	-	-	-	-	-
WDL 2.5/...	6	6	8/5	-	-	-	-	x	-	-	-	-	x	-	-	-
WDT 1.5	6.5	6.5	8/5	-	-	-	-	-	-	-	-	-	-	-	-	-
WDTR 2.5...	6.2	6	8/5	-	-	x	-	-	-	-	-	-	-	-	-	-
WDU (WPE) 120/150	32	5	10/5	-	-	-	-	x	-	-	-	x	-	-	-	-
WDU (WPE) 35 N	16	5	12/5	-	x	x	x	x	-	-	-	-	x	-	-	-
WDU (WPE) 70/95	27	5	12/5	-	-	-	-	x	-	-	-	x	-	-	-	-
WDU (WPE) 70N	20.5	5	12/5	-	x	x	x	x	-	-	-	-	x	-	-	-
WDU 1.5 LD/BLA	5.08	5	12/5	-	x	x	x	x	-	-	-	-	x	-	-	-
WDU 1.5/BLA	5.08	5	12/5	-	x	x	x	x	-	-	-	-	x	-	-	-
WDU 1.5/BLZ R7.62	7.62	5	-	-	-	-	-	-	-	-	-	-	x	-	-	-
WDU 1.5/BLZ/5.08	5.08	5	12/5	-	x	x	x	x	-	-	-	-	x	-	-	-
WDU 1.5/BLZ/LD/5.08	5.08	5	12/5	-	x	x	x	x	-	-	-	-	x	-	-	-
WDU 1.5/R 3.5...	3.5	3.5	-	-	-	-	-	-	-	-	-	-	-	-	-	-
WDU 1.5/R/BLA	5.08	5	12/5	-	x	x	x	x	-	-	-	-	x	-	-	-
WDU 1.5/ZZ	5	5	12/5	-	x	x	x	x	-	-	-	-	x	-	-	-
WDU 10 SL	10	5	12/5	-	x	x	x	x	x	x	-	-	x	-	-	-
WDU 10...	10	5	12/5	-	x	x	x	x	x	x	-	-	x	-	-	-
WDU 16 (ZA)	12	5	12/5	-	x	x	x	x	-	-	x	-	x	-	-	-
WDU 16 N	12	5	12/5	-	x	x	x	x	-	-	-	-	x	-	-	-
WDU 2.5 F	5	5	12/5	-	-	-	-	x	-	-	-	-	-	-	-	-
WDU 2.5 FF	5	5	12/5	-	x	-	-	x	-	-	-	-	-	-	-	-
WDU 2.5 N (WDU 1.5)	5	5	12/5	-	x	x	x	x	-	-	-	-	x	-	-	-
WDU 2.5 TC...	5	5	12/5	-	x	x	-	x	-	-	-	-	x	-	-	-
WDU 2.5...	5	5	12/5	-	x	x	x	x	x	-	-	-	x	-	-	-
WDU 2.5/1.5/ZZ	5	5	12/5	-	x	x	x	x	-	-	-	-	x	-	-	-
WDU 2.5/BLZ R7.62	7.62	5	-	-	-	-	-	-	-	-	-	-	x	-	-	-
WDU 240...	36	5	12/5	-	-	-	-	-	-	-	-	-	-	-	-	-
WDU 35	16	5	12/5	-	x	x	x	x	-	-	x	-	x	-	-	-
WDU 4 ...	6	6	12/6	-	x	x	x	x	x	-	-	-	x	-	-	-
WDU 4N ...	6	6	12/6	-	x	x	x	x	-	-	-	-	x	-	-	-
WDU 50N	18.5	5	12/5	-	-	-	-	-	-	-	-	-	-	-	-	-
WDU 6 ...	8	8	12/8	-	x	x	x	x	x	x	-	-	x	-	-	-
WDU 95N	27	8	15/5	-	-	-	-	-	-	-	-	-	-	-	-	-
WDUL 4	6	6	12/6	-	x	x	x	x	x	-	-	-	x	-	-	-
WEW 32/1	12.2	5	12/5	-	x	x	x	x	-	-	-	x	x	-	-	-
WEW 35/1	12.2	5	12/5	-	x	x	x	x	-	-	-	x	x	-	-	-
WEW 35/2	8	8	12/5	-	x	x	x	x	-	-	x	-	-	-	-	x
WF 10...	35.6	6	15/5	-	-	-	-	-	-	-	-	-	-	-	-	-
WF 12...	35.6	6	15/5	-	-	-	-	-	-	-	-	-	-	-	-	-
WF 5...	13	6	15/5	-	-	-	-	-	-	-	-	-	-	-	-	-
WF 6...	19.6	6	15/5	-	-	-	-	-	-	-	-	-	-	-	-	-
WF 8...	24.6	6	15/5	-	-	-	-	-	-	-	-	-	-	-	-	-
WFF 120...	42	5	12/6.5	-	-	-	-	-	-	-	-	-	-	-	-	-
WFF 185...	55	5	12/6.5	-	-	-	-	-	-	-	-	-	-	-	-	-
WFF 300...	55	5	12/6.5	-	-	-	-	-	-	-	-	-	-	-	-	-
WFF 35...	27	5	12/5	-	-	-	-	-	-	-	-	-	-	-	-	-
WFF 70...	32	5	12/6.5	-	-	-	-	-	-	-	-	-	-	-	-	-
WGK	8-25	5.6.8	10/5	10/5	-	-	-	-	-	-	-	-	-	-	-	-
WMA 4...	6	6	12/6	-	x	x	x	x	x	-	-	-	x	-	-	-
WNT 10	10	5	12/5	-	x	x	x	x	-	-	-	-	x	-	-	-
WNT 16 N	12	5	12/5	-	x	x	x	x	-	-	-	-	x	-	-	-
WNT 2.5	5	5	12/5	-	x	x	x	x	-	-	-	-	x	-	-	-

¹⁾ = WS 10/6 Middle; ²⁾ = WS 10/5 Middle; ³⁾ = SnapMark

Terminal markers – Selection table

Marking systems

Designation	Terminal width	DEK	WS	ZS	SchT 7	SchT 9/4	SchT 14/6	WTS 3/4	WGB 5/ WAD 5	WGB 8/ WAD 8	WAD 12	WAD 27	ZGB 15/ ZGB 30	BZT 1	BZT 2	EM 8/30
WNT 35 N	16	5	12/5	-	x	x	x	x	-	-	-	-	x	-	-	-
WNT 4	6	6	12/6	-	x	x	x	x	-	-	-	-	x	-	-	-
WNT 6	8	8	12/5	-	x	x	x	x	-	-	-	-	x	-	-	-
WNT 70 N	20.5	5	12/5	-	x	x	x	x	-	-	-	-	x	-	-	-
WPE 1.5/R3.5	3.5	3.5	12/3.5	-	-	-	-	-	-	-	-	-	-	-	-	-
WPE 1.5/ZZ	5	5	12/5	-	x	x	x	x	-	-	-	-	x	-	-	-
WPE 10...	10	5	12/5	-	x	x	x	x	-	-	-	-	x	-	-	-
WPE 120	32	8	12/6.5	-	-	-	-	-	-	-	-	-	-	-	-	-
WPE 16	12	5	12/5	-	x	x	x	x	-	-	-	-	x	-	-	-
WPE 16 N	12	5	12/5	-	x	x	x	x	-	-	-	-	x	-	-	-
WPE 2.5 N (WPE 1.5)	5	5	12/5	-	x	x	x	x	-	-	-	-	x	-	-	-
WPE 2.5...	5	5	12/5	-	x	x	x	x	-	-	-	-	x	-	-	-
WPE 2.5/1.5/ZR	5	5	12/5	-	-	-	-	-	-	-	-	-	-	-	-	-
WPE 35...	16	5	12/5	-	x	x	x	x	-	-	-	-	x	-	-	-
WPE 4	6	6	12/6	-	x	x	x	x	-	-	-	-	x	-	-	-
WPE 4N	6	6	12/6	-	-	-	-	-	-	-	-	-	-	-	-	-
WPE 50N	18.5	8	12/6.5	-	-	-	-	-	-	-	-	-	-	-	-	-
WPE 6	8	8	12/5	-	x	x	x	x	-	-	-	-	x	-	-	-
WPE 95N/120N	27	8	15/5	-	-	-	-	-	-	-	-	-	-	-	-	-
WPO 4	6	6	10/6	-	-	-	-	-	-	-	-	-	x	-	-	-
WSI 6...	8	8	12/5	-	-	-	-	x	-	-	-	-	x	-	-	-
WSI 6/2...	12	8	12/6.5	-	-	-	-	-	-	-	-	-	-	-	-	-
WTD 6/1	8	8	12/5	-	-	-	-	x	-	-	-	-	x	-	-	-
WTL 4 ...	6	6	12/6	-	-	-	-	-	-	-	-	-	-	-	-	-
WTL 6/1...	8	8	12/8	-	-	-	-	x	-	-	-	-	x	-	-	-
WTL 6/2	8	8	12/8	-	-	-	-	x	-	-	-	-	x	-	-	-
WTL 6/3...	8	8	12/8	-	-	-	-	x	-	-	-	-	x	-	-	-
WTQ 6/1	8	8	12/8	-	-	-	-	x	-	-	-	-	x	-	-	-
WTR 2.5 ...	5	5	12/5	-	-	-	-	x	-	-	-	-	x	-	-	-
WTR 4...	6	6	12/6	-	-	-	-	-	-	-	-	-	-	-	-	-
ZAP/TW ZIA 1.5/...	3.8	3.5	-	-	-	-	-	-	-	-	-	-	-	-	-	-
ZDK 1.5...	3.5	3.5	12/3.5	-	-	-	-	-	-	-	-	-	-	-	-	-
ZDK 2.5...	5	5	12/5	15/5	-	-	-	x	-	-	-	-	x	-	-	-
ZDK 2.5-2...	5	5	10/5	10/5	-	-	-	-	-	-	-	-	-	-	-	-
ZDK 2.5/3AN	5	5	10/5	10/5	-	-	-	-	-	-	-	-	-	-	-	-
ZDK 4/S/...	6	6	-	12/6	-	-	-	x	-	-	-	-	x	-	-	-
ZDK 6/S/...	8	8	-	-	-	-	-	x	-	-	-	-	x	-	-	-
ZDKPE 2.5	5	5	10/5	10/5	-	-	-	-	-	-	-	-	-	-	-	-
ZDL 2.5/...	5	5	-	10/5	-	-	-	-	-	-	-	-	x	-	-	-
ZDLD 2.5-2...	5	5	-	10/5	-	-	-	-	-	-	-	-	x	-	-	-
ZDT 2.5 ...	5	5	10/5	10/5	-	-	-	-	-	-	-	-	-	-	-	-
ZDTPE 2.5...	5	5	10/5	10/5	-	-	-	-	-	-	-	-	-	-	-	-
ZDTR 2.5	5	5	12/5	15/5	-	-	-	x	-	-	-	-	x	-	-	-
ZDU (ZPE) 10	10	5	12/5	15/5	-	x	-	-	-	-	-	-	x	x	x	-
ZDU (ZPE) 10/S...	10	5	10/5	15/5	-	x	-	-	-	-	-	-	x	x	x	-
ZDU (ZPE) 16...	12	5	12/5	15/5	-	x	-	x	-	-	-	-	x	x	x	-
ZDU (ZPE) 16/S...	12	5	10/5	15/5	-	x	-	-	-	-	-	-	x	x	x	-
ZDU (ZPE) 2.5N	5	5	10/5	10/5	-	-	-	-	-	-	-	-	-	-	-	-
ZDU (ZPE) 2.5 ...	5	5	12/5	15/5	-	-	-	x	-	-	-	-	x	x	x	-
ZDU (ZPE) 2.5-2/...	5	5	12/5	15/5	-	-	-	x	-	-	-	-	x	-	-	-
ZDU (ZPE) 35...	16	5	12/5	15/5	-	-	-	x	-	-	-	-	x	x	x	-
ZDU (ZPE) 4...	6	6	12/6	12/6	-	-	-	x	-	-	-	-	x	x	x	-
ZDU (ZPE) 4-2...	6	6	12/6	12/6	-	-	-	-	-	-	-	-	-	-	-	-
ZDU (ZPE) 6...	8	8	12/8	15/5	-	-	-	x	-	-	-	-	x	x	x	-
ZDU (ZPE) 6-2...	8	8	12/8	12/6	-	-	-	-	-	-	-	-	-	-	-	-
ZDU 1.5...	3.5	3.5	12/3.5	-	-	-	-	-	-	-	-	-	-	x	x	-
ZDUA (ZPEA) 2.5-2	5	5	8/5	15/5	-	-	-	x	-	-	-	-	x	-	-	-
ZDUA 2.5-2N	5	5	10/5	10/5	-	-	-	-	-	-	-	-	-	-	-	-
ZDUB (ZPEB) 2.5-2/...	5	5	8/5	15/5	-	-	-	-	-	-	-	-	x	-	-	-
ZEI 16	16	5	12/5	15/5	-	-	-	x	-	-	-	-	x	-	-	-
ZEI 6	10	8	12/6	12/6	-	-	-	x	-	-	-	-	x	x	x	-
ZEW 35/2	8	8	-	-	-	-	-	-	-	-	-	-	-	-	-	x
ZIA 1.5 ...	5.08	5	8/5	15/5	-	-	-	x	-	-	-	-	x	-	-	-
ZMAK 2.5	5	5	10/5	15/5	-	-	-	-	-	-	-	-	x	-	-	-
ZNT 10/S	10	5	-	-	-	-	-	-	-	-	-	-	-	-	-	-
ZNT 16/S	12	5	-	-	-	-	-	-	-	-	-	-	-	-	-	-
ZNT 2.5/S	5	5	10/5	10/5	-	-	-	-	-	-	-	-	-	-	-	-
ZNT 4/S	6	6	10/6	12/6	-	-	-	-	-	-	-	-	-	-	-	-
ZNT 6/S	8	8	10/6	12/6	-	-	-	-	-	-	-	-	-	-	-	-
ZP 2.5...	5	5	10/5	10/5	-	-	-	-	-	-	-	-	-	-	-	-
ZPE 16-2/1 AN	12	8	12/6	12/6	-	-	-	-	-	-	-	-	-	-	-	-
ZPV 1.5	5.08	5	12/5	15/5	-	x	x	x	-	-	-	-	x	-	-	-
ZRV 1.5...	5	5	8/5	10/5	-	x	x	x	-	-	-	-	x	-	-	-
ZSI 2.5...	8	8	12/5	15/5	-	-	-	x	-	-	-	-	x	-	-	-
ZSI 2.5/2...	12	5	12/5	15/5	-	-	-	x	-	-	-	-	x	-	-	-
ZSI 6-2/FC	8	6	12/6	12/6	-	-	-	-	-	-	-	-	-	-	-	-
ZT 2.5 ...	5	5	10/5	10/5	-	-	-	-	-	-	-	-	-	-	-	-
ZTD 6	8	8	12/6.5	-	-	-	-	-	-	-	-	-	-	-	-	-
ZTL 6	8	8	12/6.5	-	-	-	-	-	-	-	-	-	-	-	-	-
ZTPE 2.5 ...	5	5	10/5	10/5	-	-	-	-	-	-	-	-	-	-	-	-
ZTR 2.5...	5	5	12/5	15/5	-	-	-	x	-	-	-	-	x	-	-	-
ZTR 2.5-2...	5	5	14/5	10/5	-	-	-	-	-	-	-	-	-	-	-	-
PDL 4...	5	5	12/5	-	-	-	-	-	-	-	-	-	-	-	-	-
PDU 2.5/4...	5	5	12/5	-	-	-	-	-	-	-	-	-	-	-	-	-
PDU 6/10...	8	8	10/8	-	-	-	-	-	-	-	-	-	-	-	-	-

K

Designation	Terminal width	DEK	WS	ZS	SchT 7	SchT 9/4	SchT 14/6	WTS 3/4	WGB 5/ WAD 5	WGB 8/ WAD 8	WAD 12	WAD 27	ZGB 15/ ZGB 30	BZT 1	BZT 2	EM 8/30
PDU 16	12	-	10/12	-	-	-	-	-	-	-	-	-	-	-	-	-
PKD 2.5/4	5	5	12/5	-	-	-	-	-	-	-	-	-	-	-	-	-
PPE 2.5/4	5	5	12/5	-	-	-	-	-	-	-	-	-	-	-	-	-
PPE 6/10	8	8	10/8	-	-	-	-	-	-	-	-	-	-	-	-	-
PPE 16	12	-	10/12	-	-	-	-	-	-	-	-	-	-	-	-	-
PNT 2.5/4	5	5	12/5	-	-	-	-	-	-	-	-	-	-	-	-	-
PNT 6/10	8	8	10/8	-	-	-	-	-	-	-	-	-	-	-	-	-
PNT 16	12	-	10/12	-	-	-	-	-	-	-	-	-	-	-	-	-
PEI 16	12	-	10/12	-	-	-	-	-	-	-	-	-	-	-	-	-
AST 1-4/35	6.2	6	-	-	-	-	-	-	-	-	-	-	-	-	-	-
AST 5/35	6.5	6	-	-	-	-	-	-	-	-	-	-	-	-	-	-
DK 4...	6	6	-	-	-	-	-	-	-	-	-	-	-	-	-	-
DKT 4...	6	6	-	-	-	-	-	-	-	-	-	-	-	-	-	-
EK 10	10	5	-	-	-	-	-	-	-	-	-	-	-	-	-	-
EK 16	12	5	-	-	-	-	-	-	-	-	-	-	-	-	-	-
EK 2.5...	6	6	-	-	-	-	-	-	-	-	-	-	-	-	-	-
EK 35...	16	5	-	-	-	-	-	-	-	-	-	-	-	-	-	-
EK 4...	6.5	6.5	-	-	-	-	-	-	-	-	-	-	-	-	-	-
EK 6/35	8	8	-	-	-	-	-	-	-	-	-	-	-	-	-	-
KDKS 1...	8	8	-	-	-	-	-	-	-	-	-	-	-	-	-	-
KSKM...	13	5	-	-	-	-	-	-	-	-	-	-	-	-	-	-
KST...	24-34	5	-	-	-	-	-	-	-	-	-	-	-	-	-	-
NT...	6-12	6	-	-	-	-	-	-	-	-	-	-	-	-	-	-
RSF 1-3...	8	5	-	-	-	-	-	-	-	-	-	-	-	-	-	-
SAK 10...	10	5	-	-	-	-	-	-	-	-	-	-	-	-	-	-
SAK 16...	12	5	-	-	-	-	-	-	-	-	-	-	-	-	-	-
SAK 2.5	6.1	6	-	-	X	-	-	-	-	-	-	-	-	-	-	-
SAK 2.5/35	5	5	-	-	X	-	-	-	-	-	-	-	-	-	-	-
SAK 35...	18	5	-	-	X	-	-	-	-	-	-	-	-	-	-	-
SAK 4...	6.5	6.5	-	-	X	-	-	-	-	-	-	-	-	-	-	-
SAK 6...	8	8	-	-	X	-	-	-	-	-	-	-	-	-	-	-
SAK 95/35	28	5	-	-	X	-	-	-	-	-	-	-	-	-	-	-
SAKC 10/35	12	6.5	-	-	X	-	-	-	-	-	-	-	-	-	-	-
SAKC 4/35	6.5	6.5	-	-	X	-	-	-	-	-	-	-	-	-	-	-
SAKG...	32-54	5	-	-	X	-	-	-	-	-	-	-	-	-	-	-
SAKR...	6.5	6.5	-	-	X	-	-	-	-	-	-	-	-	-	-	-
SAKS....	13-28	5	-	-	X	-	-	-	-	-	-	-	-	-	-	-
SAKT...	8	6.5	-	-	X	-	-	-	-	-	-	-	-	-	-	-
SAKD 2.5N	5	5	-	-	X	-	-	-	-	-	-	-	-	-	-	-
SAKA 10	12	5	-	-	X	-	-	-	-	-	-	-	-	-	-	-
SAKB 10	10	5	-	-	X	-	-	-	-	-	-	-	-	-	-	-
ASK 1	8	8	-	-	X	-	-	-	-	-	-	-	-	-	-	-
SAKK 4..	8	6.5	-	-	X	-	-	-	-	-	-	-	-	-	-	-
SAKK 10..	11.5	5	-	-	X	-	-	-	-	-	-	-	-	-	-	-
SAKH 4-10	6.5-14	5	-	-	X	-	-	-	-	-	-	-	-	-	-	-
SAKH 35	18	6.5	-	-	-	-	-	-	-	-	-	-	-	-	-	-
KMVF...	6	5	-	-	-	-	-	-	-	-	-	-	-	-	-	-
AKZ 1.5-2.5	5.1	5	-	-	-	-	-	-	-	-	-	-	-	-	-	-
AKZ 4	6.1	6	-	-	-	-	-	-	-	-	-	-	-	-	-	-
AKE 2.5	5.1	5	-	-	-	-	-	-	-	-	-	-	-	-	-	-
AKE 4	7	6.5	-	-	-	-	-	-	-	-	-	-	-	-	-	-
ADK 1	6	6	-	-	-	-	-	-	-	-	-	-	-	-	-	-
AL 1	6.5	6.5	-	-	-	-	-	-	-	-	-	-	-	-	-	-
AKA 4	6	6	-	-	-	-	-	-	-	-	-	-	-	-	-	-

DEK card with printing

The Dekafix marker is the universal marker for terminals and plug-in connectors as well as electronic modules from the Weidmüller product range. Dekafix provides you with a wide range of standard printing options. The system is particularly suitable for short sequences of numbers and is also available with customer specific printing.

- In strips for fast installation
- Large selection of ready-to-use printed markers
- Excellent printing quality thanks to the MC Laser
- Available in 4 widths
- Custom printing also possible

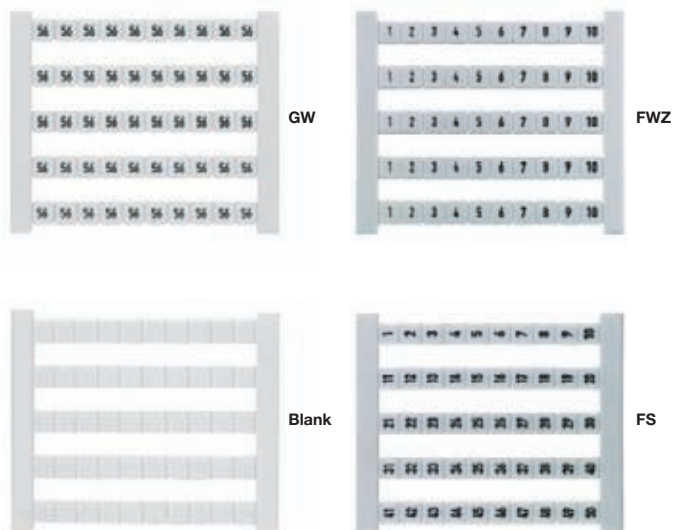

Technical data

Material	Polyamide 66, halogen-free
UL 94 flammability rating	V2
Temperature range	-40 °C to 100 °C
Printing	black

Ordering data

Colour	Available in all colours of the international colour code; for MC on request		
	● brown	● red	● orange
	● yellow	● green	● blue
	● violet	● grey	○ white
Qty	500 pcs		
Pitch	DEK 5 = 5 mm : DEK 6 = 6 mm : DEK 6.5 = 6.5 mm : DEK 8 = 8 mm		
Printing variations	FZ = consecutive horizontal	e.g. DEK 5 FW 1-50	
	FS = consecutive vertical	e.g. DEK 5 FS 51-100	
	FWZ = consecutive horizontal line	e.g. DEK 5 FWZ 1-10	
	FSZ = consecutive vertical line	e.g. DEK 5 FSZ 21-30	
	GW = identical horizontal	e.g. DEK 5 GW A	
	GS = identical vertical	e.g. DEK 5 GS B	
No. of characters	horizontal	vertical	
Dek 5	max. 3 characters	max. 3 characters	
Dek 6	max. 3 characters	max. 3 characters	
Dek 6,5	max. 4 characters	max. 3 characters	
Dek 8	max. 5 characters	max. 3 characters	
Specify colour and characters for special printing			

Versions DEK

Type/Print	Order No.	Type/Print	Order No.	Type/Print	Order No.	Type/Print	Order No.
DEK 5 BL NEUTRAL	0473391693	DEK 5 FW X6-Z6	0133261155	DEK 5 GW 16	0522660016	DEK 5 GW 88	0522660088
DEK 5 BR NEUTRAL	0473391692	DEK 5 FW X7-Z7	0133261156	DEK 5 GW 17	0522660017	DEK 5 GW 89	0522660089
DEK 5 FS 1-50	0473560001	DEK 5 FW X8-Z8	0133261157	DEK 5 GW 18	0522660018	DEK 5 GW 90	0522660090
DEK 5 FS 101-150	0473560101	DEK 5 FW X9-Z9	0133261158	DEK 5 GW 19	0522660019	DEK 5 GW 91	0522660091
DEK 5 FS 151-200	0473560151	DEK 5 FWZ 1-10	0523060001	DEK 5 GW 20	0522660020	DEK 5 GW 92	0522660092
DEK 5 FS 201-250	0473560201	DEK 5 FWZ 1-19	0235860000	DEK 5 GW 21	0522660021	DEK 5 GW 93	0522660093
DEK 5 FS 251-300	0473560251	DEK 5 FWZ 1-9	1572000000	DEK 5 GW 22	0522660022	DEK 5 GW 94	0522660094
DEK 5 FS 301-350	0473560301	DEK 5 FWZ 11-20	0523060011	DEK 5 GW 23	0522660023	DEK 5 GW 95	0522660095
DEK 5 FS 351-400	0473560351	DEK 5 FWZ 2-20	0236160000	DEK 5 GW 24	0522660024	DEK 5 GW 96	0522660096
DEK 5 FS 401-450	0473560401	DEK 5 FWZ 21-30	0523060021	DEK 5 GW 25	0522660025	DEK 5 GW 97	0522660097
DEK 5 FS 451-500	0473560451	DEK 5 FWZ 21-39	0235960000	DEK 5 GW 26	0522660026	DEK 5 GW 98	0522660098
DEK 5 FS 501-550	0473560501	DEK 5 FWZ 22-40	0236260000	DEK 5 GW 27	0522660027	DEK 5 GW 99	0522660099
DEK 5 FS 51-100	0473560051	DEK 5 FWZ 31-40	0523060031	DEK 5 GW 28	0522660028	DEK 5 GW 100	0522660100
DEK 5 FS 551-600	0473560551	DEK 5 FWZ 41-50	0523060041	DEK 5 GW 29	0522660029	DEK 5 GW 101	0522660101
DEK 5 FS 601-650	0473560601	DEK 5 FWZ 41-59	0236060000	DEK 5 GW 30	0522660030	DEK 5 GW 102	0522660102
DEK 5 FS 651-700	0473560651	DEK 5 FWZ 42-60	0236360000	DEK 5 GW 31	0522660031	DEK 5 GW 103	0522660103
DEK 5 FS 701-750	0473560701	DEK 5 FWZ 51-60	0523060051	DEK 5 GW 32	0522660032	DEK 5 GW 104	0522660104
DEK 5 FS 751-800	0473560751	DEK 5 FWZ 61-70	0523060061	DEK 5 GW 33	0522660033	DEK 5 GW 105	0522660105
DEK 5 FS 801-850	0473560801	DEK 5 FWZ 71-80	0523060071	DEK 5 GW 34	0522660034	DEK 5 GW 106	0522660106
DEK 5 FS 851-900	0473560851	DEK 5 FWZ 81-90	0523060081	DEK 5 GW 35	0522660035	DEK 5 GW 107	0522660107
DEK 5 FS 901-950	0473560901	DEK 5 FWZ 91-100	0523060091	DEK 5 GW 36	0522660036	DEK 5 GW 108	0522660108
DEK 5 FSZ 1-10	0460660001	DEK 5 FWZ L1-EIK	0354361203	DEK 5 GW 37	0522660037	DEK 5 GW 109	0522660109
DEK 5 FSZ 11-20	0460660011	DEK 5 FWZ L1-PE	0354361187	DEK 5 GW 38	0522660038	DEK 5 GW 110	0522660110
DEK 5 FSZ 18,20,...32	0582360018	DEK 5 FWZ U,V,W,N,PE	0558360000	DEK 5 GW 39	0522660039	DEK 5 GW 111	0522660111
DEK 5 FSZ 2,4,6,...16	0582360002	DEK 5 GE NEUTRAL	0473391687	DEK 5 GW 40	0522660040	DEK 5 GW 112	0522660112
DEK 5 FSZ 21-30	0460660021	DEK 5 GN NEUTRAL	0473391688	DEK 5 GW 41	0522660041	DEK 5 GW 113	0522660113
DEK 5 FSZ 31-40	0460660031	DEK 5 GR NEUTRAL	0473391691	DEK 5 GW 42	0522660042	DEK 5 GW 114	0522660114
DEK 5 FSZ 41-50	0460660041	DEK 5 GS A	0132961021	DEK 5 GW 43	0522660043	DEK 5 GW 115	0522660115
DEK 5 FSZ 51-60	0460660051	DEK 5 GS B	0132961022	DEK 5 GW 44	0522660044	DEK 5 GW 116	0522660116
DEK 5 FSZ 61-70	0460660061	DEK 5 GS C	0132961023	DEK 5 GW 45	0522660045	DEK 5 GW 117	0522660117
DEK 5 FSZ 71-80	0460660071	DEK 5 GS D	0132961024	DEK 5 GW 46	0522660046	DEK 5 GW 118	0522660118
DEK 5 FSZ 81-90	0460660081	DEK 5 GS E	0132961025	DEK 5 GW 47	0522660047	DEK 5 GW 119	0522660119
DEK 5 FSZ 91-100	0460660091	DEK 5 GS F	0132961026	DEK 5 GW 48	0522660048	DEK 5 GW 120	0522660120
DEK 5 FW 1,3,5,...99	1358460000	DEK 5 GS G	0132961027	DEK 5 GW 49	0522660049	DEK 5 GW 121	0522660121
DEK 5 FW 1-50	0473460001	DEK 5 GS H	0132961028	DEK 5 GW 50	0522660050	DEK 5 GW 122	0522660122
DEK 5 FW 101-500	0132660010	DEK 5 GS I	0132961029	DEK 5 GW 51	0522660051	DEK 5 GW 123	0522660123
DEK 5 FW 101-150	0473460101	DEK 5 GS J	0132961030	DEK 5 GW 52	0522660052	DEK 5 GW 124	0522660124
DEK 5 FW 151-200	0473460151	DEK 5 GS K	0132961031	DEK 5 GW 53	0522660053	DEK 5 GW 125	0522660125
DEK 5 FW 2,4,...100	1358560000	DEK 5 GS L	0132961032	DEK 5 GW 54	0522660054	DEK 5 GW 126	0522660126
DEK 5 FW 201-250	0473460201	DEK 5 GS M	0132961033	DEK 5 GW 55	0522660055	DEK 5 GW 127	0522660127
DEK 5 FW 251-300	0473460251	DEK 5 GS N	0132961034	DEK 5 GW 56	0522660056	DEK 5 GW 128	0522660128
DEK 5 FW 301-350	0473460301	DEK 5 GS O	0132961035	DEK 5 GW 57	0522660057	DEK 5 GW 129	0522660129
DEK 5 FW 351-400	0473460351	DEK 5 GS P	0132961036	DEK 5 GW 58	0522660058	DEK 5 GW 130	0522660130
DEK 5 FW 401-450	0473460401	DEK 5 GS PE	0157261187	DEK 5 GW 59	0522660059	DEK 5 GW 131	0522660131
DEK 5 FW 451-500	0473460451	DEK 5 GS Q	0132961037	DEK 5 GW 60	0522660060	DEK 5 GW 132	0522660132
DEK 5 FW 501-550	0473460501	DEK 5 GS R	0132961038	DEK 5 GW 61	0522660061	DEK 5 GW 133	0522660133
DEK 5 FW 51-100	0473460051	DEK 5 GS S	0132961039	DEK 5 GW 62	0522660062	DEK 5 GW 134	0522660134
DEK 5 FW 551-600	0473460551	DEK 5 GS T	0132961040	DEK 5 GW 63	0522660063	DEK 5 GW 135	0522660135
DEK 5 FW 601-650	0473460601	DEK 5 GS U	0132961041	DEK 5 GW 64	0522660064	DEK 5 GW 136	0522660136
DEK 5 FW 651-700	0473460651	DEK 5 GS V	0132961042	DEK 5 GW 65	0522660065	DEK 5 GW 137	0522660137
DEK 5 FW 701-750	0473460701	DEK 5 GS W	0132961043	DEK 5 GW 66	0522660066	DEK 5 GW 138	0522660138
DEK 5 FW 751-800	0473460751	DEK 5 GS X	0132961044	DEK 5 GW 67	0522660067	DEK 5 GW 139	0522660139
DEK 5 FW 801-850	0473460801	DEK 5 GS Y	0132961045	DEK 5 GW 68	0522660068	DEK 5 GW 140	0522660140
DEK 5 FW 851-900	0473460851	DEK 5 GS Z	0132961046	DEK 5 GW 69	0522660069	DEK 5 GW 141	0522660141
DEK 5 FW 901-950	0473460901	DEK 5 GS \perp	0157261202	DEK 5 GW 70	0522660070	DEK 5 GW 142	0522660142
DEK 5 FW 951-999	0473460951	DEK 5 GS \oplus	0157261203	DEK 5 GW 71	0522660071	DEK 5 GW 143	0522660143
DEK 5 FW U1-PE1	0133161114	DEK 5 GW	0576260000	DEK 5 GW 72	0522660072	DEK 5 GW 144	0522660144
DEK 5 FW U2-PE2	0133161115	DEK 5 GW 1	0522660001	DEK 5 GW 73	0522660073	DEK 5 GW 145	0522660145
DEK 5 FW U3-PE3	0133161116	DEK 5 GW 2	0522660002	DEK 5 GW 74	0522660074	DEK 5 GW 146	0522660146
DEK 5 FW U4-PE4	0133161117	DEK 5 GW 3	0522660003	DEK 5 GW 75	0522660075	DEK 5 GW 147	0522660147
DEK 5 FW U5-PE5	0133161118	DEK 5 GW 4	0522660004	DEK 5 GW 76	0522660076	DEK 5 GW 148	0522660148
DEK 5 FW U6-PE6	0133161119	DEK 5 GW 5	0522660005	DEK 5 GW 77	0522660077	DEK 5 GW 149	0522660149
DEK 5 FW U7-PE7	0133161120	DEK 5 GW 6	0522660006	DEK 5 GW 78	0522660078	DEK 5 GW 150	0522660150
DEK 5 FW U8-PE8	0133161121	DEK 5 GW 7	0522660007	DEK 5 GW 79	0522660079	DEK 5 GW 151	0522660151
DEK 5 FW U9-PE9	0133161122	DEK 5 GW 8	0522660008	DEK 5 GW 80	0522660080	DEK 5 GW 152	0522660152
DEK 5 FW X1-Z1	0133261150	DEK 5 GW 9	0522660009	DEK 5 GW 81	0522660081	DEK 5 GW 153	0522660153
DEK 5 FW X10-Z10	0133261159	DEK 5 GW 10	0522660010	DEK 5 GW 82	0522660082	DEK 5 GW 154	0522660154
DEK 5 FW X2-Z2	0133261151	DEK 5 GW 11	0522660011	DEK 5 GW 83	0522660083	DEK 5 GW 155	0522660155
DEK 5 FW X3-Z3	0133261152	DEK 5 GW 12	0522660012	DEK 5 GW 84	0522660084	DEK 5 GW 156	0522660156
DEK 5 FW X4-Z4	0133261153	DEK 5 GW 13	0522660013	DEK 5 GW 85	0522660085	DEK 5 GW 157	0522660157
DEK 5 FW X5-Z5	0133261154	DEK 5 GW 14	0522660014	DEK 5 GW 86	0522660086	DEK 5 GW 158	0522660158
		DEK 5 GW 15	0522660015	DEK 5 GW 87	0522660087	DEK 5 GW 159	0522660159

Versions DEK

Type/Print	Order No.	Type/Print	Order No.	Type/Print	Order No.	Type/Print	Order No.
DEK 5 GW 160	0522660160	DEK 5 GW N	0522761034	DEK 6 FS 201-250	0468760201	DEK 6 FWZ L1-⊕	0631961203
DEK 5 GW 161	0522660161	DEK 5 GW n	0522861060	DEK 6 FS 251-300	0468760251	DEK 6 FWZ L1-PE	0631961187
DEK 5 GW 162	0522660162	DEK 5 GW O	0522761035	DEK 6 FS 301-350	0468760301	DEK 6 FWZ R,S,T,N,⊥	0631860000
DEK 5 GW 163	0522660163	DEK 5 GW o	0522861061	DEK 6 FS 351-400	0468760351	DEK 6 GE NEUTRAL	0468591687
DEK 5 GW 164	0522660164	DEK 5 GW P	0522761036	DEK 6 FS 401-450	0468760401	DEK 6 GN NEUTRAL	0468591688
DEK 5 GW 165	0522660165	DEK 5 GW p	0522861062	DEK 6 FS 451-500	0468760451	DEK 6 GR NEUTRAL	0468591691
DEK 5 GW 166	0522660166	DEK 5 GW PE	0537261187	DEK 6 FS 501-550	0468760501	DEK 6 GW 0	0526961000
DEK 5 GW 167	0522660167	DEK 5 GW PEN	0537261188	DEK 6 FS 51-100	0468760051	DEK 6 GW 1	0526960001
DEK 5 GW 168	0522660168	DEK 5 GW Q	0522761037	DEK 6 FS 551-600	0468760051	DEK 6 GW 2	0526960002
DEK 5 GW 169	0522660169	DEK 5 GW q	0522861063	DEK 6 FS 601-650	0468760061	DEK 6 GW 3	0526960003
DEK 5 GW 170	0522660170	DEK 5 GW R	0522761038	DEK 6 FS 651-700	0468760061	DEK 6 GW 4	0526960004
DEK 5 GW 171	0522660171	DEK 5 GW r	0522861064	DEK 6 FS 701-750	0468760071	DEK 6 GW 5	0526960005
DEK 5 GW 172	0522660172	DEK 5 GW RT/SW +	0576291737	DEK 6 FS 751-800	0468760071	DEK 6 GW 6	0526960006
DEK 5 GW 173	0522660173	DEK 5 GW S	0522761039	DEK 6 FS 801-850	0468760081	DEK 6 GW 7	0526960007
DEK 5 GW 174	0522660174	DEK 5 GW s	0522861065	DEK 6 FS 851-900	0468760081	DEK 6 GW 8	0526960008
DEK 5 GW 175	0522660175	DEK 5 GW T	0522761040	DEK 6 FS 901-950	0468760091	DEK 6 GW 9	0526960009
DEK 5 GW 176	0522660176	DEK 5 GW t	0522861066	DEK 6 FS 951-999	0468760091	DEK 6 GW 10	0526960010
DEK 5 GW 177	0522660177	DEK 5 GW U	0522761041	DEK 6 FSZ 1-110	0133360001	DEK 6 GW 11	0526960011
DEK 5 GW 178	0522660178	DEK 5 GW u	0522861067	DEK 6 FSZ 11-20	0133360011	DEK 6 GW 12	0526960012
DEK 5 GW 179	0522660179	DEK 5 GW V	0522761042	DEK 6 FSZ 21-30	0133360021	DEK 6 GW 13	0526960013
DEK 5 GW 180	0522660180	DEK 5 GW v	0522861068	DEK 6 FSZ 31-40	0133360031	DEK 6 GW 14	0526960014
DEK 5 GW 181	0522660181	DEK 5 GW W	0522761043	DEK 6 FSZ 41-50	0133360041	DEK 6 GW 15	0526960015
DEK 5 GW 182	0522660182	DEK 5 GW w	0522861069	DEK 6 FSZ 51-60	0133360051	DEK 6 GW 16	0526960016
DEK 5 GW 183	0522660183	DEK 5 GW W-STROM	0576261215	DEK 6 FSZ 61-70	0133360061	DEK 6 GW 17	0526960017
DEK 5 GW 184	0522660184	DEK 5 GW X	0522761044	DEK 6 FSZ 71-80	0133360071	DEK 6 GW 18	0526960018
DEK 5 GW 185	0522660185	DEK 5 GW x	0522861070	DEK 6 FSZ 81-90	0133360081	DEK 6 GW 19	0526960019
DEK 5 GW 186	0522660186	DEK 5 GW Y	0522761045	DEK 6 FSZ 91-100	0133360091	DEK 6 GW 20	0526960020
DEK 5 GW 187	0522660187	DEK 5 GW y	0522861071	DEK 6 FW 1,3,5...99	1358660000	DEK 6 GW 21	0526960021
DEK 5 GW 188	0522660188	DEK 5 GW Z	0522761046	DEK 6 FW 1-5 (10X)	0688660000	DEK 6 GW 22	0526960022
DEK 5 GW 189	0522660189	DEK 5 GW z	0522861072	DEK 6 FW 1-50	0468660001	DEK 6 GW 23	0526960023
DEK 5 GW 190	0522660190	DEK 5 GW +	0576261198	DEK 6 FW 101-150	0468660101	DEK 6 GW 24	0526960024
DEK 5 GW 191	0522660191	DEK 5 GW -	0576261199	DEK 6 FW 151-200	0468660151	DEK 6 GW 25	0526960025
DEK 5 GW 192	0522660192	DEK 5 GW ⊥	0576261202	DEK 6 FW 2,4,...100	1358760000	DEK 6 GW 26	0526960026
DEK 5 GW 193	0522660193	DEK 5 GW ⊕	0576261203	DEK 6 FW 251-300	0468660201	DEK 6 GW 27	0526960027
DEK 5 GW 194	0522660194	DEK 5 NEUTRAL	0473360000	DEK 6 FW 301-350	0468660251	DEK 6 GW 28	0526960028
DEK 5 GW 195	0522660195	DEK 5 OR NEUTRAL	0473391690	DEK 6 FW 351-400	0468660301	DEK 6 GW 29	0526960029
DEK 5 GW 196	0522660196	DEK 5 RT NEUTRAL	0473391686	DEK 6 FW 401-450	0468660351	DEK 6 GW 30	0526960030
DEK 5 GW 197	0522660197	DEK 5 SW NEUTRAL	0473391694	DEK 6 FW 451-500	0468660401	DEK 6 GW 31	0526960031
DEK 5 GW 198	0522660198	DEK 5 VI NEUTRAL	0473391689	DEK 6 FW 501-550	0468660451	DEK 6 GW 32	0526960032
DEK 5 GW 199	0522660199			DEK 6 FW 551-600	0468660501	DEK 6 GW 33	0526960033
DEK 5 GW 200	0522660200	DEK 5/3,5 MC FS 1-10	1762320001	DEK 6 FW 601-650	0468660551	DEK 6 GW 34	0526960034
DEK 5 GW A	0522761021	DEK 5/3,5 MC FS 101-110	1762320101	DEK 6 FW 651-700	0468660601	DEK 6 GW 35	0526960035
DEK 5 GW a	0522861047	DEK 5/3,5 MC FS 11-20	1762320011	DEK 6 FW 701-750	0468660651	DEK 6 GW 36	0526960036
DEK 5 GW B	0522761022	DEK 5/3,5 MC FS 111-120	1762320111	DEK 6 FW 751-800	0468660701	DEK 6 GW 37	0526960037
DEK 5 GW b	0522861048	DEK 5/3,5 MC FS 121-130	1762320121	DEK 6 FW 801-850	0468660751	DEK 6 GW 38	0526960038
DEK 5 GW BL/SW -	0576291741	DEK 5/3,5 MC FS 131-140	1762320131	DEK 6 FW 851-900	0468660801	DEK 6 GW 39	0526960039
DEK 5 GW C	0522761023	DEK 5/3,5 MC FS 141-150	1762320141	DEK 6 FW 901-950	0468660851	DEK 6 GW 40	0526960040
DEK 5 GW c	0522861049	DEK 5/3,5 MC FS 21-30	1762320021	DEK 6 FW 951-999	0468660901	DEK 6 GW 41	0526960041
DEK 5 GW d	0522761024	DEK 5/3,5 MC FS 31-40	1762320031	DEK 6 FW 991-999	0468660951	DEK 6 GW 42	0526960042
DEK 5 GW d	0522861050	DEK 5/3,5 MC FS 41-50	1762320041	DEK 6 FW L,N,PE	0632560000	DEK 6 GW 43	0526960043
DEK 5 GW E	0522761025	DEK 5/3,5 MC FS 51-60	1762320051	DEK 6 FWZ 1-10	0518960001	DEK 6 GW 44	0526960044
DEK 5 GW e	0522861051	DEK 5/3,5 MC FS 61-70	1762320061	DEK 6 FWZ 101-110	0518960101	DEK 6 GW 45	0526960045
DEK 5 GW F	0522761026	DEK 5/3,5 MC FS 71-80	1762320071	DEK 6 FWZ 111-120	0518960111	DEK 6 GW 46	0526960046
DEK 5 GW f	0522861052	DEK 5/3,5 MC FS 81-90	1762320081	DEK 6 FWZ 121-130	0518960121	DEK 6 GW 47	0526960047
DEK 5 GW G	0522761027	DEK 5/3,5 MC FS 91-100	1762320091	DEK 6 FWZ 131-140	0518960131	DEK 6 GW 48	0526960048
DEK 5 GW g	0522861053	DEK 5/3,5 MC GW 0	1755281000	DEK 6 FWZ 141-150	0518960141	DEK 6 GW 49	0526960049
DEK 5 GW H	0522761028	DEK 5/3,5 MC GW 1	1755280001	DEK 6 FWZ 151-160	0518960151	DEK 6 GW 50	0526960050
DEK 5 GW h	0522861054	DEK 5/3,5 MC GW 2	1755280002	DEK 6 FWZ 161-170	0518960161	DEK 6 GW 51	0526960051
DEK 5 GW I	0522761029	DEK 5/3,5 MC GW 3	1755280003	DEK 6 FWZ 171-180	0518960171	DEK 6 GW 52	0526960052
DEK 5 GW i	0522861055	DEK 5/3,5 MC GW 4	1755280004	DEK 6 FWZ 181-190	0518960181	DEK 6 GW 53	0526960053
DEK 5 GW J	0522761030	DEK 5/3,5 MC GW 5	1755280005	DEK 6 FWZ 191-200	0518960191	DEK 6 GW 54	0526960054
DEK 5 GW j	0522861056	DEK 5/3,5 MC GW 6	1755280006	DEK 6 FWZ 201-210	0518960201	DEK 6 GW 55	0526960055
DEK 5 GW K	0522761031	DEK 5/3,5 MC GW 7	1755280007	DEK 6 FWZ 21-30	0518960021	DEK 6 GW 56	0526960056
DEK 5 GW k	0522861057	DEK 5/3,5 MC GW 8	1755280008	DEK 6 FWZ 31-40	0518960031	DEK 6 GW 57	0526960057
DEK 5 GW L	0522761032	DEK 5/3,5 MC GW 9	1755280009	DEK 6 FWZ 41-50	0518960041	DEK 6 GW 58	0526960058
DEK 5 GW I	0522861058			DEK 6 FWZ 51-60	0518960051	DEK 6 GW 59	0526960059
DEK 5 GW L1	0522361075	DEK 6 NEUTRAL	0468560000	DEK 6 FWZ 61-70	0518960061	DEK 6 GW 60	0526960060
DEK 5 GW L2	0522361076	DEK 6 BL NEUTRAL	0468591693	DEK 6 FWZ 71-80	0518960071	DEK 6 GW 61	0526960061
DEK 5 GW L3	0522361077	DEK 6 BR NEUTRAL	0468591692	DEK 6 FWZ 81-90	0518960081	DEK 6 GW 62	0526960062
DEK 5 GW M	0522761033	DEK 6 FS 1-50	0468760001	DEK 6 FWZ 91-100	0518960091	DEK 6 GW 63	0526960063
DEK 5 GW m	0522861059	DEK 6 FS 101-150	0468760101			DEK 6 GW 64	0526960064
DEK 5 GW MP	0537261235	DEK 6 FS 151-200	0468760151			DEK 6 GW 65	0526960065

Versions DEK

Type/Print	Order No.
DEK 6 GW 66	0526960066
DEK 6 GW 67	0526960067
DEK 6 GW 68	0526960068
DEK 6 GW 69	0526960069
DEK 6 GW 70	0526960070
DEK 6 GW 71	0526960071
DEK 6 GW 72	0526960072
DEK 6 GW 73	0526960073
DEK 6 GW 74	0526960074
DEK 6 GW 75	0526960075
DEK 6 GW 76	0526960076
DEK 6 GW 77	0526960077
DEK 6 GW 78	0526960078
DEK 6 GW 79	0526960079
DEK 6 GW 80	0526960080
DEK 6 GW 81	0526960081
DEK 6 GW 82	0526960082
DEK 6 GW 83	0526960083
DEK 6 GW 84	0526960084
DEK 6 GW 85	0526960085
DEK 6 GW 86	0526960086
DEK 6 GW 87	0526960087
DEK 6 GW 88	0526960088
DEK 6 GW 89	0526960089
DEK 6 GW 90	0526960090
DEK 6 GW 91	0526960091
DEK 6 GW 92	0526960092
DEK 6 GW 93	0526960093
DEK 6 GW 94	0526960094
DEK 6 GW 95	0526960095
DEK 6 GW 96	0526960096
DEK 6 GW 97	0526960097
DEK 6 GW 98	0526960098
DEK 6 GW 99	0526960099
DEK 6 GW 100	0526960100
DEK 6 GW 200	0526960200
DEK 6 GW BL/SW -	1318091741
DEK 6 GW PE	1318061187
DEK 6 GW RT/SW +	1318091737
DEK 6 GW +	1318061198
DEK 6 GW -	1318061199
DEK 6 GW $\frac{1}{2}$	1318061202
DEK 6 GW \oplus	1318061203
DEK 6 NEUTRAL	0468560000
DEK 6 OR NEUTRAL	0468591690
DEK 6 RT NEUTRAL	0468591686
DEK 6 SW NEUTRAL	0468591694
DEK 6 VI NEUTRAL	0468591689
DEK 6,5 BL NEUTRAL	0468091693
DEK 6,5 FS 1-50	0468260001
DEK 6,5 FS 101-150	0468260101
DEK 6,5 FS 151-200	0468260151
DEK 6,5 FS 201-250	0468260201
DEK 6,5 FS 251-300	0468260251
DEK 6,5 FS 301-350	0468260301
DEK 6,5 FS 351-400	0468260351
DEK 6,5 FS 401-450	0468260401
DEK 6,5 FS 451-500	0468260451
DEK 6,5 FS 501-550	0468260501
DEK 6,5 FS 51-100	0468260051
DEK 6,5 FS 551-600	0468260551
DEK 6,5 FS 601-650	0468260601
DEK 6,5 FS 651-700	0468260651
DEK 6,5 FS 701-750	0468260701
DEK 6,5 FS 751-800	0468260751
DEK 6,5 FS 801-850	0468260801
DEK 6,5 FS 851-900	0468260851
DEK 6,5 FS 901-950	0468260901
DEK 6,5 FS 951-999	0468260951
DEK 6,5 FSZ 1-10	0407360001
DEK 6,5 FSZ 11-20	0407360011

Type/Print	Order No.
DEK 6,5 FSZ 21-30	0407360021
DEK 6,5 FSZ 31-40	0407360031
DEK 6,5 FSZ 41-50	0407360041
DEK 6,5 FSZ 51-60	0407360051
DEK 6,5 FSZ 61-70	0407360061
DEK 6,5 FSZ 71-80	0407360071
DEK 6,5 FSZ 81-90	0407360081
DEK 6,5 FSZ 91-100	0407360091
DEK 6,5 FW 1-50	0468160001
DEK 6,5 FW 101-150	0468160101
DEK 6,5 FW 151-200	0468160151
DEK 6,5 FW 201-250	0468160201
DEK 6,5 FW 251-300	0468160251
DEK 6,5 FW 301-350	0468160301
DEK 6,5 FW 351-400	0468160351
DEK 6,5 FW 401-450	0468160401
DEK 6,5 FW 451-500	0468160451
DEK 6,5 FW 501-550	0468160501
DEK 6,5 FW 51-100	0468160051
DEK 6,5 FW 551-600	0468160551
DEK 6,5 FW 601-650	0468160601
DEK 6,5 FW 651-700	0468160651
DEK 6,5 FW 701-750	0468160701
DEK 6,5 FW 751-800	0468160751
DEK 6,5 FW 801-850	0468160801
DEK 6,5 FW 851-900	0468160851
DEK 6,5 FW 901-950	0468160901
DEK 6,5 FW 951-999	0468160951
DEK 6,5 FW L1- \oplus	0632161203
DEK 6,5 FW L1-PE	0632161187
DEK 6,5 FWZ 1-10	0519060001
DEK 6,5 FWZ 11-20	0519060011
DEK 6,5 FWZ 21-30	0519060021
DEK 6,5 FWZ 31-40	0519060031
DEK 6,5 FWZ 41-50	0519060041
DEK 6,5 FWZ 51-60	0519060051
DEK 6,5 FWZ 61-70	0519060061
DEK 6,5 FWZ 71-80	0519060071
DEK 6,5 FWZ 81-90	0519060081
DEK 6,5 FWZ 91-100	0519060091
DEK 6,5 FWZ R,S,T,N,ERD	0632060000
DEK 6,5 GE NEUTRAL	0468091687
DEK 6,5 GN NEUTRAL	0468091688
DEK 6,5 NEUTRAL	0468060000
DEK 6,5 OR NEUTRAL	0468091690
DEK 6,5 RT NEUTRAL	0468091686
DEK 6,5 SW NEUTRAL	0468091694
DEK 6,5 VI NEUTRAL	0468091689
DEK 8 BEDR./FARBIG	1289690000
DEK 8 FS 1-50 TAMPOPR.	1653350001
DEK 8 FS 1-50 TAMPOPR.	1653350001
DEK 8 FS 51-100 TAMPOPR.	1653350051
DEK 8 FS 51-100 TAMPOPR.	1653350051
DEK 8 FSZ 1-10	1289660001
DEK 8 FSZ 11-20	1289660011
DEK 8 FSZ 21-30	1289660021
DEK 8 FSZ 31-40	1289660031
DEK 8 FSZ 41-50	1289660041
DEK 8 FSZ 51-60	1289660051
DEK 8 FSZ 61-70	1289660061
DEK 8 FSZ 71-80	1289660071
DEK 8 FSZ 81-90	1289660081
DEK 8 FSZ 91-100	1289660091
DEK 8 FW 1-50 TAMPOPR.	1653340001
DEK 8 FW 1-50 TAMPOPR.	1653340001
DEK 8 FW 51-100 TAMPOPR.	1653340051
DEK 8 FW 51-100 TAMPOPR.	1653340051
DEK 8 FWZ 1-10	1276960001
DEK 8 FWZ 101-110	1276960101
DEK 8 FWZ 11-20	1276960011
DEK 8 FWZ 111-120	1276960111

Type/Print	Order No.
DEK 8 FWZ 121-130	1276960121
DEK 8 FWZ 131-140	1276960131
DEK 8 FWZ 141-150	1276960141
DEK 8 FWZ 21-30	1276960021
DEK 8 FWZ 31-40	1276960031
DEK 8 FWZ 41-50	1276960041
DEK 8 FWZ 51-60	1276960051
DEK 8 FWZ 61-70	1276960061
DEK 8 FWZ 71-80	1276960071
DEK 8 FWZ 81-90	1276960081
DEK 8 FWZ 91-100	1276960091
DEK 8 GE NEUTRAL	1277091687
DEK 8 GN NEUTRAL	1277091688
DEK 8 NEUTRAL	1277060000
DEK 8 OR NEUTRAL	1277091690
DEK 8 RT NEUTRAL	1277091686
DEK 8 SONDERDR. FARBIG	1326690000
DEK 8 SONDERDR. WEIß	1326660000
DEK 8 VI NEUTRAL	1277091689
WS 8/5 Karte	1773360000
WS 10/5 Karte	1773370000
WS 12/5 Karte	1773380000
WS 12/5 FSZ 1 - 10	1773430001
WS 12/5 FSZ 11 - 20	1773430011
WS 12/5 FSZ 21 - 30	1773430021
WS 12/5 FSZ 31 - 40	1773430031
WS 12/5 FSZ 41 - 50	1773430041
WS 12/5 FWZ 1 - 10	1773330001
WS 12/5 FWZ 11 - 20	1773330011
WS 12/5 FWZ 21 - 30	1773330021
WS 12/5 FWZ 31 - 40	1773330031
WS 12/5 FWZ 41 - 50	1773330041

DEK MultiCard

The Dekafix marker in MultiCard format is the universal marker for all kinds of connectors and also electronic modules from the Weidmüller product range. The blank DEK marker is ideal for flexible, fast printing in situ with our innovative labelling systems SMark-Laser, PrintJet, MCP Plus Plotter or MC-Mobilo. The system is particularly suitable for short sequences of numbers and is also available with special printing.

- In strips for fast installation
- Flexible, fast printing on site during installation
- Excellent printing quality thanks to the Weidmüller MultiCard printers
- Available in 6 widths
- Custom printing with the MC Laser also possible

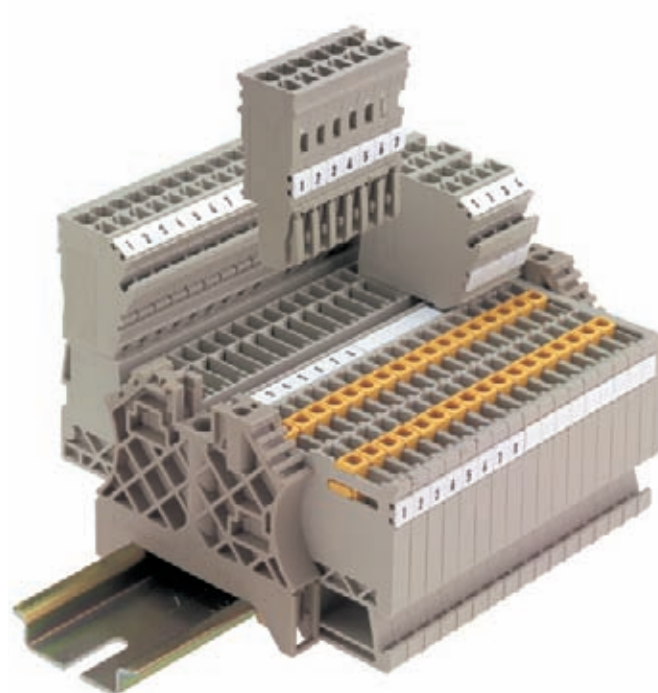

Technical data

Material	Polyamide 66, halogen-free
UL 94 flammability rating	V2
Temperature range	-40 °C to 100 °C
Printing	black

Ordering data

Colour	Available in all colours of the international colour code; for MC on request									
	<table border="0"> <tr> <td>● brown</td> <td>● red</td> <td>● orange</td> </tr> <tr> <td>● yellow</td> <td>● green</td> <td>● blue</td> </tr> <tr> <td>● violet</td> <td>● grey</td> <td>○ white</td> </tr> </table>	● brown	● red	● orange	● yellow	● green	● blue	● violet	● grey	○ white
● brown	● red	● orange								
● yellow	● green	● blue								
● violet	● grey	○ white								
Special printing	Specify special printing and colours per diskette, Excel file or using the M-Print® PRO software.									
Minimum order quantity	1 pack									
Notes on mounting	<p>Mount in strips when the marker pitch (width) corresponds to the pitch of the terminals. For example, DEK 5 mm pitch for terminals with 5 mm pitch such as the WDU 2.5.</p> <p>Mount individual markers when the terminal pitch is larger than the marker pitch (width). For example, DEK 6.5 mount individually on WDU 6 terminals.</p>									

Dekafix - the universal marker for SAK series, W-series, Z-series, P-series and I-series plus WEICOS connectors and electronics devices.



Clamping width: 3.5 mm

DEK - blank

Ordering data

Type	Colour of material	Length	Qty.	Order No.
DEK 5/3,5 MC	white	5 mm	500	1755270000

DEK - Custom printing

Type	Colour of material	Length	Qty.	Order No.
DEK 5/3,5 MC	white	5 mm	100	1767730000

Clamping width: 5.0 mm

DEK - blank

Type	Colour of material	Length	Qty.	Order No.
DEK 5/5 Plus MC	white	5 mm	1000	1854490000
DEK 5/5 Plus MC GE	yellow	5 mm	1000	1907520000
DEK 5/5 MC	white	5 mm	1000	1609801044
DEK 5/5 MC GE	yellow	5 mm	1000	1609801687
DEK 5/5 MC BL	blue	5 mm	1000	1609801693
DEK 5/5 MC GR	grey	5 mm	1000	1609801691
DEK 5/5 MC GN	green	5 mm	1000	1609801688
DEK 5/5 MC RT	red	5 mm	1000	1609801686
DEK 5/30 MC	white	30 mm	100	1951920000

DEK - Custom printing

Type	Colour of material	Length	Qty.	Order No.
DEK 5/5 MC	white	5 mm	200	1609810000
DEK 5/5 Plus MC	white	5 mm	200	1854500000
DEK 5/30 MC	 white	30 mm	20	1025680000

Clamping width: 6.0 mm

DEK - blank

Type	Colour of material	Length	Qty.	Order No.
DEK 5/6 MC	white	5 mm	1000	1609820000
DEK 5/6 Plus MC	 white	5 mm	100	1011320000

DEK - Custom printing

Type	Colour of material	Length	Qty.	Order No.
DEK 5/6 MC	white	5 mm	200	1609830000

Clamping width: 6.5 mm

DEK - blank

Type	Colour of material	Length	Qty.	Order No.
DEK 5/6,5 MC	white	5 mm	900	1609840000

DEK - Custom printing

Type	Colour of material	Length	Qty.	Order No.
DEK 5/6,5 MC	white	5 mm	180	1609850000

Clamping width: 7.5 mm

DEK - blank

Type	Colour of material	Length	Qty.	Order No.
DEK 5/7,5 MC	white	5 mm	320	1720620000

DEK - Custom printing

Type	Colour of material	Length	Qty.	Order No.
DEK 5/7,5 MC	white	5 mm	320	1770490000

Clamping width: 8.0 mm

DEK - blank

Type	Colour of material	Length	Qty.	Order No.
DEK 5/8 MC	white	5 mm	800	1856740000

DEK - Custom printing

Type	Colour of material	Length	Qty.	Order No.
DEK 5/8 MC	white	5 mm	160	1856750000

WS

WS markers are designed specifically for W series terminals. But thanks to their system compatibility, WS markers can also be used with the I series, Z series and P series. The generous size of these markers permit long characters strings and multiple-line printing.

WS markers are ideal for labelling where long, individual character strings are required. And the proven MultiCard format makes labelling possible with the SMark-Laser, PrintJet, MCP Plus Plotter or MC-Mobilo as well.

- Mount in strips or individually
- Markers in the proven MultiCard format
- Excellent printing quality thanks to the Weidmüller MultiCard printers



Technical data

Material	Polyamide 66, halogen-free
UL 94 flammability rating	V2
Temperature range	-40 °C to 100 °C
Printing	black

Ordering data

Colour	Available in all colours of the international colour code; for MC on request									
	<table border="0"> <tr> <td>● brown</td> <td>● red</td> <td>● orange</td> </tr> <tr> <td>● yellow</td> <td>● green</td> <td>● blue</td> </tr> <tr> <td>● violet</td> <td>● grey</td> <td>○ white</td> </tr> </table>	● brown	● red	● orange	● yellow	● green	● blue	● violet	● grey	○ white
● brown	● red	● orange								
● yellow	● green	● blue								
● violet	● grey	○ white								
Special printing	Specify special printing and colours per diskette, Excel file or using the M-Print® PRO software.									
Minimum order quantity	1 pack									
Notes on mounting	<p>Mount in strips when the marker pitch (width) corresponds to the pitch of the terminals. For example, WS 10/6 = 6 mm pitch for terminals with 6 mm pitch such as the WDU 4.</p> <p>Mount individual markers when the terminal pitch is larger than the marker pitch (width). For example, WS 12/6.5 mount individually on WDU 6 terminals. Weidmüller markers with 5 mm pitch (width) are suitable for all widths of terminals.</p>									

ZS

ZS

ZS markers – in the proven MultiCard format – were specially developed for Z series terminals. They provide users with a large labelling area. Their unique hinged form means that cross-connectors, for example, are still readily accessible without having to remove the marker. Markers can be clipped on in strips to guarantee fast installation, but individual markers are easily separated.

- Hinged labelling area
- Mount in strips or individually
- Markers in the proven MultiCard format
- Flexible, fast printing on site during installation



Technical data

Material	Polyamide 66, halogen-free
UL 94 flammability rating	V2
Temperature range	-40 °C to 100 °C
Printing	black

Ordering data

Colour	white
Notes on mounting	height x width (pitch), e.g. ZS 10/5 10 mm high, 5 mm wide = 5 mm pitch
Special printing	Specify special printing and colours per diskette, Excel file or using the M-Print® PRO software.
Suitable printing systems	SMark-Laser, PrintJet, MCP Plus Plotter, MC-Mobilo
Minimum order quantity	1 pack

Terminal markers – WS / ZS

WS markers are perfect for the connectors of the W-series, I-series, P-series and Z-series. The WS 10/5 and 10/6 Middle, are fitted with a centre foot and can be used for the I-series. The ZS markers are specially designed for the Z-series.

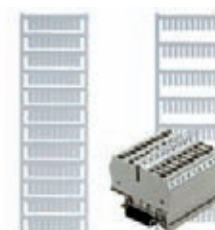

Clamping width: 3.5 mm

WS - blank

Ordering data

Type	Colour of material	Length	Qty.	Order No.
WS 12/3,5 MC	white	12 mm	600	1778270000

WS - Custom printing

Type	Colour of material	Length	Qty.	Order No.
WS 12/3,5 MC	white	12 mm	120	1778280000

Clamping width: 5.0 mm

WS - blank

Type	Colour of material	Length	Qty.	Order No.
WS 8/5 MC	white	8 mm	720	1640740000
WS 8/5 MC GE	yellow	8 mm	720	1773521687
WS 8/5 MC RT	red	8 mm	720	1773521686
WS 8/5 MC BL	blue	8 mm	720	1773521693
WS 8/5 MC OR	orange	8 mm	720	1773521690
WS 8/5 PLUS MC	white	8 mm	600	1951870000
WS 10/5 MC	white	10 mm	720	1635000000
WS 10/5 MC Middle	white	10 mm	720	1792000000
WS 10/5 MC GE	yellow	10 mm	720	1773531687
WS 10/5 MC RT	red	10 mm	720	1773531686
WS 10/5 MC BL	blue	10 mm	720	1773531693
WS 12/5 MC	white	12 mm	720	1609860000
WS 12/5 MC GE	yellow	12 mm	720	1773541687
WS 12/5 MC RT	red	12 mm	720	1773541686
WS 12/5 MC BL	blue	12 mm	720	1773541693
WS 12/5 MC OR	orange	12 mm	720	1773541690
WS 12/5 MC PLUS	white	12 mm	600	1927510000
WS 14/5 MC	white	14 mm	480	1768090000
WS 15/5 MC	white	15 mm	480	1609880000
WS 15/5 MC GE	yellow	15 mm	480	1773571687

WS - Custom printing

Type	Colour of material	Length	Qty.	Order No.
WS 8/5 MC	white	8 mm	144	1640750000
WS 10/5 MC	white	10 mm	144	1635010000
WS 10/5 MC Middle	white	10 mm	144	1792010000
WS 12/5 MC	white	12 mm	144	1609870000
WS 12/5 MC PLUS	white	12 mm	60	1927520000
WS 15/5 MC	white	15 mm	96	1609890000

Clamping width: 6.0 mm

WS - blank

Type	Colour of material	Length	Qty.	Order No.
WS 8/6 PLUS MC	white	8 mm	600	1951880000
WS 10/6 MC	white	10 mm	600	1828450000
WS 10/6 MC Middle	white	10 mm	600	1818400000
WS 10/6 MC Middle GN	green	10 mm	600	1917420000
WS 10/6 MC Middle GE	yellow	10 mm	600	1917430000
WS 10/6 MC Middle RT	red	10 mm	600	1917440000
WS 10/6 MC Middle OR	orange	10 mm	600	1917410000
WS 12/6 MC	white	12 mm	600	1609900000
WS 12/6 MC GE	yellow	12 mm	600	1773551687
WS 12/6 MC RT	red	12 mm	600	1773551686
WS 12/6 MC BL	blue	12 mm	600	1773551693
WS 12/6 MC OR	orange	12 mm	600	1773551690
WS 12/6 MC BR	brown	12 mm	600	1773551692
WS 12/6 MC VI	violet	12 mm	600	1773551689
WS 12/6 MC PLUS	white	12 mm	600	1927530000

WS markers are perfect for the connectors of the W-series, I-series, P-series and Z-series. WS 10/5 and 10/6 Middle are fitted with a centre foot and can be used for the I-series. The ZS markers are specially designed for the Z-series.

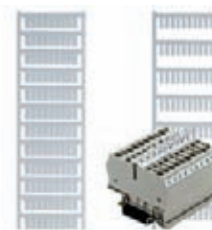

WS - Custom printing

Ordering data

Type	Colour of material	Length	Qty.	Order No.
WS 10/6 MC	white	10 mm	120	1828460000
WS 10/6 MC Middle	white	10 mm	120	1818410000
WS 12/6 MC	white	12 mm	120	1609910000
WS 12/6 MC PLUS	white	12 mm	120	1927540000

Clamping width: 6.5 mm

WS - blank

Type	Colour of material	Length	Qty.	Order No.
WS 12/6,5 MC	white	12 mm	540	1609920000
WS 12/6,5 MC GE	yellow	12 mm	540	1773561687
WS 12/6,5 MC RT	red	12 mm	540	1773561686
WS 12/6,5 MC BL	blue	12 mm	540	1773561693
WS 12/6,5 MC GN	green	12 mm	540	1773561688

WS - Custom printing

Type	Colour of material	Length	Qty.	Order No.
WS 12/6,5 MC	white	12 mm	108	1609930000

Clamping width: 8.0 mm

WS - blank

Type	Colour of material	Length	Qty.	Order No.
WS 10/8 MC	white	10 mm	420	1905950000
WS 12/8 MC	white	12 mm	420	1906000000

WS - Custom printing

Type	Colour of material	Length	Qty.	Order No.
WS 10/8 MC	white	10 mm	84	1906030000
WS 12/8 MC	white	12 mm	84	1906010000

Clamping width: 12.0 / 15.0 mm

WS - blank

Type	Colour of material	Length	Qty.	Order No.
WS 10/12 MC	white	10 mm	300	1905970000
WS 10/15 MC	white	10 mm	240	1854090000

WS - Custom printing

Type	Colour of material	Length	Qty.	Order No.
WS 10/12 MC	white	10 mm	60	1906060000
WS 10/15 MC	white	10 mm	48	1854100000

Clamping width: 5.0 mm

ZS - blank

Type	Colour of material	Length	Qty.	Order No.
ZS 10/5 MC	white	10 mm	480	1610000000
ZS 15/5 MC	white	15 mm	480	1646630000

ZS - Custom printing

Type	Colour of material	Length	Qty.	Order No.
ZS 10/5 MC	white	10 mm	96	1610010000
ZS 15/5 MC	white	15 mm	96	1646640000

Clamping width: 6.0 mm

ZS - blank

Type	Colour of material	Length	Qty.	Order No.
ZS 12/6 MC	white	12 mm	400	1610020000

ZS - Custom printing

Type	Colour of material	Length	Qty.	Order No.
ZS 12/6 MC	white	12 mm	80	1610030000

Terminal markers – Tag carrier



This tag holder is specially conceived for the IDK 1.5N two-tier terminal of the I-series. The flexible hinge mechanism allows cross-connections to be connected or disconnected at little effort. It can be fitted with four DEK 5 tags or two WS 10/5 Middle connector markers.

Snap Mark

Technical specification

Material	Polyamide 66
UL 94 flammability rating	V2
Min. temperature, continuous	-40 °C
Max. temperature, continuous	100 °C
Colour of material	white

Accessories

Ordering data

Type	Length	Width	Qty.	Order No.
Snap Mark I	23 mm	5 mm	50	1805880000

Type	Length	Width	Qty.	Order No.
WS 10/5 MC Middle	10 mm	5 mm	720	1792000000
DEK 5/5 MC	5 mm	5 mm	1000	1609801044



The BZT marker carrier enables clear labelling of the ZDU 2.5/4/6 and ZDUA terminal range. The BZT is equipped with the WS 10/5 connector marker. The ZA version ensures maximum stability due to block construction of the marker carrier.

BZT1 / BZT2

Technical specification

Material	Polyamide
UL 94 flammability rating	V2
Min. temperature, continuous	-40 °C
Max. temperature, continuous	100 °C
Colour of material	beige

Accessories

Ordering data

Type	Length	Width	Qty.	Order No.
BZT 1	8 mm	5 mm	100	1805490000
BZT 1 ZA	8 mm	5 mm	100	1805520000
BZT 2	12 mm	5 mm	100	1805480000
BZT 2 ZA	12 mm	5 mm	100	1805530000

Type	Length	Width	Qty.	Order No.
WS 10/5 MC	10 mm	5 mm	720	1635000000



SCHT 5 / SCHT 5 S

Technical specification

Material	Polyamide 66
UL 94 flammability rating	V2
Min. temperature, continuous	-40 °C
Max. temperature, continuous	100 °C
Colour	beige

Accessories

The SCHT 5 & SCHT 5 S group marker carrier is clipped directly to the TS 32 DIN rail (G-rail) or the TS 35 DIN rail (top-hat rail). It is therefore possible to provide terminal strip labelling irrespective of the terminal and the type of terminal.

Ordering data

Type	Length	Width	Qty.	Order No.
SCHT 5	44,5 mm	19.5 mm	20	0292460000
SCHT 5 S	44,5 mm	9.5 mm	20	1631930000

Type	Length	Width	No. per sheet	Qty.	Order No.
ESO 5 white	40 mm	16.5 mm	60	10	1607710000
ESO 5 yellow	40 mm	16.5 mm	60	10	1631350000
ESO 5P white	40 mm	16.5 mm	60	10	1670370000
ESO 5P yellow	40 mm	16.5 mm	60	10	1670380000
ESO 5 S white	40 mm	7 mm	140	10	1631920000
STR 5 F.SCHT 5	40 mm	16.5 mm		20	0294000000
STR 5 S. F.SCHT 5 S	40 mm	7 mm		20	1631940000



SCHT 7

Technical specification

Material	Polyamide 66
UL 94 flammability rating	V2
Min. temperature, continuous	-40 °C
Max. temperature, continuous	100 °C
Colour	white

Accessories

The SCHT 7 is a hinged group marker carrier for inlay tags which still allows easy access to the clamping screw. To equip with ESO 7, 4 tags of DEK 5/5 or 2 tags of WS 10/5 Middle.

Ordering data

Type	Length	Width	Qty.	Order No.
SCHT 7	39.3 mm	8 mm	20	0517960000

Type	Length	Width	No. per sheet	Qty.	Order No.
DEK 5/5 MC	5 mm	5 mm		1000	1609801044
ESO 7 white	27 mm	6.3 mm	240	10	1607720000
ESO 7 yellow	27 mm	6.3 mm	240	10	1634780000
ESO 7P white	27 mm	6.3 mm	240	10	1670390000
ESO 7P yellow	27 mm	6.3 mm	240	10	1670400000
STR 7 SCHT 7	27 mm	6.3 mm		20	0515300000
WS 10/5 MC Middle	10 mm	5 mm		720	1792000000

Terminal markers – Tag carrier



SCHT 9/4 and SCHT 14/6 are hinged group marker carriers for single dekafix and WS tags, allowing easy access to the clamping screws.

SCHT 9/4 / SCHT 14/6

Technical specification

Material	Polyamide 66
UL 94 flammability rating	V2
Min. temperature, continuous	-40 °C
Max. temperature, continuous	100 °C
Colour	beige

Accessories

Ordering data

Type	Length	Width	Qty.	Order No.
SCHT 14/6	44.3 mm	6 mm	20	1269060000
SCHT 9/4	32 mm	4 mm	20	1278460000

Type	Length	Width	Qty.	Order No.
DEK 5/5 MC	5 mm	5 mm	1000	1609801044
WS 12/5 MC	12 mm	5 mm	720	1609860000



WGB group marker carrier for single dekafix and WS tags. The WGB also covers the cross-connection channels.

Blank WAD covers for labelling with STI pen, or a special printing for the W-series. Cross-connection channels are covered. Also available with lightning flash warning symbol to DIN 30600.

WGB 5 / WGB 8 / WAD

Technical specification

Material	Polyamide 66
UL 94 flammability rating	V2
Min. temperature, continuous	-40 °C
Max. temperature, continuous	100 °C

Ordering data

Type	Length	Width	Colour	Qty.	Order No.
WGB 5	33.5 mm	5 mm	beige	50	1050760000
WGB 8	33.5 mm	7.7 mm	beige	50	1050960000
WAD 5	33.5 mm	5 mm	white	50	1056060000
WAD 5 lightning flash	33.5 mm	5 mm	yellow	50	1053460000
WAD 8	33.5 mm	8 mm	white	50	1056160000
WAD 8 lightning flash	33.5 mm	8 mm	yellow	50	1053560000
WAD 12	36.2 mm	12 mm	white	50	1056260000
WAD 12 lightning flash	36.2 mm	12 mm	yellow	50	1055960000
WAD 27	64 mm	27 mm	white	10	1062960000
WAD 27 lightning flash	64 mm	27 mm	yellow	10	1062860000

WAD – Custom printing

Type	Length	Width	Colour	Qty.	Order No.
WAD 5	33.5 mm	5 mm	white	100	1790060000
WAD 8	33.5 mm	8 mm	white	50	1667700000

Accessories – WGB 5 / WGB 8

Type	Length	Width	Qty.	Order No.
DEK 5/5 MC	5 mm	5 mm	1000	1609801044
DEK 5/30 MC	5 mm	30 mm	100	1951920000
WS 12/5 MC	12 mm	5 mm	720	1609860000



The ZGB 15 / ZGB 30 is a hinged marker carrier. The tag holder can be fitted with the dekafix 5, WS 12/5 connector markers or with the push-in tag ESO 15 / ESO 7.

ZGB 15 / ZGB 30

Technical specification

Material	Polyamide 66
UL 94 flammability rating	V2
Min. temperature, continuous	-40 °C
Max. temperature, continuous	100 °C
Colour	white

Accessories

Ordering data

Type	Length	Width	Qty.	Order No.
ZGB 15	15 mm	7 mm	20	1636530000
ZGB 30	32 mm	7 mm	20	1611930000

Type	Length	Width	No. per sheet	Qty.	Order No.
DEK 5/5 MC	5 mm	5 mm		1000	1609801044
ESO 7 white	27 mm	6.3 mm	240	10	1607720000
ESO 7 yellow	27 mm	6.3 mm	240	10	1634780000
ESO 7P white	27 mm	6.3 mm	240	10	1670390000
ESO 7P yellow	27 mm	6.3 mm	240	10	1670400000
ESO 15 white	15 mm	6 mm	120	1	1636510000
STR 7 SCHAT 7	27 mm	6.3 mm		20	0515300000
STR 15 ZGB 15	15 mm	6.3 mm		20	1636520000
WS 12/5 MC	12 mm	5 mm		720	1609860000



The EM 8/30 end bracket marker is suitable for labelling the WEW 35/2 and ZEW 35/2 end brackets as well as marker carrier for W-series terminals. The EM 8/30 can be fitted with the ESO 7 and ESO 7P inlay tags. The pocket guarantees that the labelling is well protected against environmental influences.

EM 8/30

Technical specification

Material	Polypropylene
UL 94 flammability rating	HB
Min. temperature, continuous	-40 °C
Max. temperature, continuous	80 °C
Colour	transparent

Accessories

Ordering data

Type	Length	Width	Qty.	Order No.
EM 8/30	30 mm	8 mm	50	1806120000

Type	Length	Width	No. per sheet	Qty.	Order No.
ESO 7 white	27 mm	6.3 mm	240	10	1607720000
ESO 7 yellow	27 mm	6.3 mm	240	10	1634780000
ESO 7P white	27 mm	6.3 mm	240	10	1670390000
ESO 7P yellow	27 mm	6.3 mm	240	10	1670400000

Printing systems and software

The Weidmüller labelling systems are the quick and efficient way of producing markers for connectors, wires, cables and devices, plus labels for general use. The **M-Print® PRO** software enables users to mark electrical equipment quickly and simply. For professional and fast design, printing and ordering of your marking requirements. Borders, barcodes, graphics or photos can all be easily integrated. The multitude of data conversion routines presents you with fast and flexible options for data integration. The Weidmüller **SMark-Laser**, **PrintJet PRO**, **MCP Plus** and **MC-Mobilo** printers plus those of the ThermoMark series can be used for printing.

The unique printing speed of the **SMark-Laser** makes it a real winner. The **PrintJet PRO** is the reference model in industrial marking for high-resolution printing and maximum wipe and scratch resistance. The **MCP Plus** plotter provides you with good flexibility because with its positioning frame it can handle more than 120 different types of marker in the MultiCard format. The **MC-Mobilo** is the ideal printer for labelling on site without a PC and a mains power supply, directly during installation work. The printers of the ThermoMark series are ideal for printing labels and/or shrinkable sleeves in excellent quality.

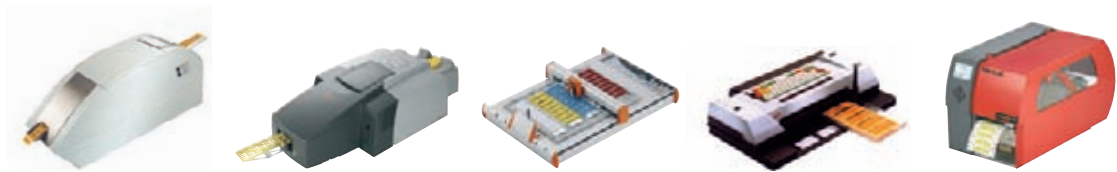

	Printer				
Type of marker	SMark-Laser	PrintJet PRO	MCP Plus plotter	MC-Mobilo	ThermoMark
Connector markers					
DEK	●	●	●	●	
WS	●	●	●	● ¹	
ZS	●	●	●	●	
MF	●	●	●	●	
Cable and wire markers					
SF	●	●	● ²	● ²	
SFX	●	●	●	●	
SFC	●	●	●	●	
TM-I	●	●	●	●	
TwinMark					●
Device markers					
DMC	●	●	●	●	
ESG	●	●	●	●	
SM	●	●	●	●	
ClipCard	●	●	●	●	
Labels					
THM MT					●
THM WriteOn					●

¹ Except WS 15/5

² SF 4 to 6 only with corresponding positioning frame

SMark-Laser

The **SMark-Laser** is a laser printer for printing on markers in the MultiCard format. The fast production of large numbers of individually printed markers is the special feature of this printer. The automatic feed function of the **SMark-Laser** increases productivity even further and ensures that your markers are available without delay.

- Fast printing speed, 4 MultiCards per minute
- Markers can be used immediately
- Fast operation irrespective of the file size
- Good flexibility thanks to production of markers in MultiCard format to meet users' requirements
- Reduces stocks because only blank markers are required
- Printing of graphics and logos as well
- Optional automatic feed for large quantities
- Can be used together with the Weidmüller **M-Print® PRO** software



Technical data

Type	SMark-Laser
Application	Prints all MultiCards
Technology	Laser printer
Printing speed	4 MultiCards per minute
Print quality	600 dpi
Printer drivers	WIN 9.x, NT, 2000/XP
Software	M-Print® PRO
System requirements	Windows® 2000/XP/Vista
Feed	Manual or with optional loader
Interfaces	Centronics
Power supply	AC 230 V / 50 Hz / 16 A
Ambient conditions	20 °C – 35 °C
Dimensions: (L x W x H)	1000 x 430 x 380 mm
Scope of supply	Laser printer, power cable, printer drivers, manual, interface cable, M-Print® PRO software

Ordering data

SMark-Laser

Type	Order No.
SMark-Laser	1767090000
Rack	1782880000
Special toner cartridge	1770070000

Print options

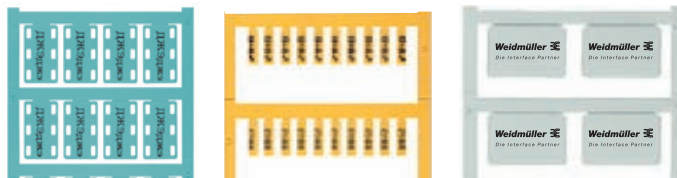

Printing systems – Inkjet printer

PrintJet PRO



The **PrintJet PRO** inkjet printer prints markers for electric connectivity. These markers can be used for clear equipment identification on devices, cables and connectors. The labelling makes servicing, maintenance and troubleshooting much easier. Water-based ink is used for the black or spot colour printing. The print is crystal clear and resistant to environmental influences. The **PrintJet PRO** prints plastic markers in **MultiCard** format. In combination with the user-friendly **M-Print® PRO** software and the attached loader, the printer becomes an essential part of the production. The inkjet process being used, the subsequent fusing, as well as the printer cartridge and ink have all been specially adapted by Weidmüller for industrial use. The printer has excellent long-term use capabilities, thanks to its integrated loader.



- Top-quality, resistant printing
- Spot colour print
- Perfect for constant use
- Integrated loader for 20 MultiCards
- Ideal for large quantities
- The display shows all relevant information
- Flexible connection options, from LAN ports to USB ports

Technical data

PrintJet PRO	
Type	PrintJet PRO
Application	Prints MultiCard markers
Technology	Inkjet process
Print quality	600 / 1.200 dpi
Printer drivers	Windows® 2000/XP/VISTA
Print software	M-Print® PRO
System requirements	Windows® 2000/XP/VISTA
Feed	Integrated loader
Fusing	Thermal fusing
Interface	USB, LAN
Power supply	AC 230 V or AC 115 V
Location	Office conditions
Ambient temperature	20° to 35 °C
Dimensions (L x W x H)	1060 x 500 x 310 mm
Weight	33 kg
Cartridge system	Ink cartridge, CMYK (480.000 characters, Arial font size 6)
Scope of supply	PrintJet printer, power cable, printer drivers, manuals (CD), USB cable, M-Print® PRO software

Ordering data

PrintJet PRO

Type	Order No.
PrintJet PRO 115V	1024050000
PrintJet PRO 230V	1001180001
Accessories	
PJ PRO TNTK INK SET BK	Ink tank starter set, black 1027090000
PJ PRO TNTK INK SET COL	Ink tank starter set, colour 1027110000
PJ PRO TNTK INK K	● Ink tank Black 1027040000
PJ PRO TNTK INK C	● Ink tank Cyan 1027050000
PJ PRO TNTK INK M	● Ink tank Magenta 1027060000
PJ PRO TNTK INK Y	● Ink tank Yellow 1027070000
PJ PRO TNTK FL	Ink tank fluid 1027080000
Ink tank PrintJet II	1858920000
Clean Unit PrintJet II	1858950000
Ink tank PrintJet	1797460000
Clean Unit PrintJet	4062150000

Note: Available starting third quarter, 2008

MCP Plus

The plotter **MCP Plus** complements the Weidmüller MultiCard concept. It is suitable for smaller quantities of markers and when only part of a MultiCard is to be printed on. The special positioning frame for five MultiCards increases productivity by 20 % over comparable systems. With the positioning frame for SlimFix markers sizes 4 to 6, printing on more than 120 MultiCard types for terminals, cables, wires and equipment is possible. Labels are printed with the MCP-Label positioning frame. Suitable for use with the Weidmüller **M-Print® PRO** software.

- 2 positioning frames for more than 120 MultiCard types
- MultiCards easily fitted into the frame
- Easy to use with partly used MultiCards
- Automatic pen activation function
- Safe storage of the plotter pens

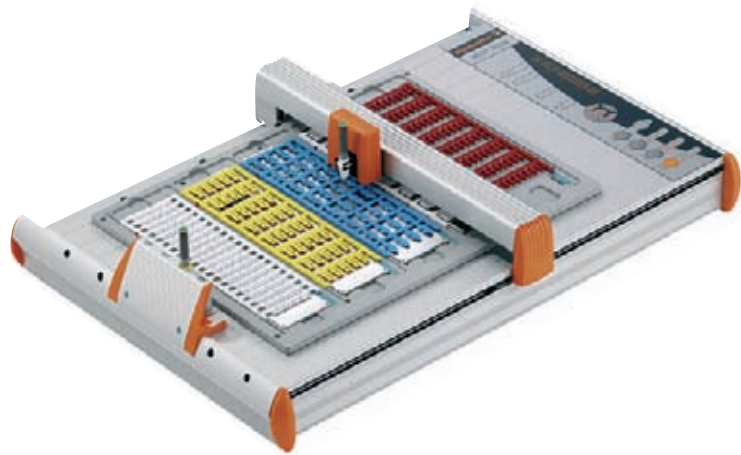

Technical data

Type	Plotter
Application	printing of MultiCard markers and labels
Technology	plotting technique
Print software	M-Print® PRO
System requirements	Windows® 2000/XP/Vista
Interface	Parallel Centronics
Power supply	230/115 V AC
Feed	manual
Location	office conditions
Ambient temperature	10 °C - 35 °C
Dimensions (L x W x H)	660 x 440 x 125 mm
Weight	approx. 8 kg
Scope of supply	MCP Plus with Centronics cable, USB cable, power pack (100-240 V AC/50-60 Hz), Euro and US plugs, MultiCard positioning frame, 0.25 mm plotter pen, M-Print® PRO software and manual

Ordering data

MCP Plus

Type	Order No.
MCP Plus plotter set	1925000000
Note:	

Printing systems – MCP Plus



MCP positioning frames

Technical specification

Ordering data

Type	for	Qty.	Order No.
MCP AP	MultiCards	1	1924360000
MCP AP SF 4-6	SlimFix sizes 4 to 6	1	1924310000
MCP AP Labels	Labels	1	1924370000

MCP plotter pens

Technical specification

Type	for	Qty.	Order No.
Plotter Pen 0.18	Reusable pen	1	1768570000
Plotter Pen 0.25	Reusable pen	1	1768540000
Plotter Pen 0.25 P-Ink	Disposable pen 8 ml	1	1920640000
Plotter Pen 0.35	Reusable pen	1	1768550000
Plotter Pen 0.35 P-Ink	Disposable pen 8 ml	1	1920650000
Plotter Pen 0.50	Reusable pen	1	1768560000
Plotter Pen 0.50 P-Ink	Disposable pen 8 ml	1	1005710000
Plotter Pen 0.70	Reusable pen	1	1011440000
Plotter Pen 0.70 P-Ink	Disposable pen 8 ml	1	1011450000

MCP ink

Technical specification

Type	Contents	Qty.	Order No.
P-Ink	22 ml	1	1924340000
Ink 2000	25 ml	1	1772120000

MCP miscellaneous

Technical specification

Type	Contents	Qty.	Order No.
MCP adhesive strips		1	1924320000
P cleaner	22 ml	1	1924330000
MCP cover		1	1924350000
Cleaner Clean 2000	25 ml	1	1772130000
Cleaning beaker		1	1288300000
Inlay for MCP Plus		1	1935130000

MCP software

Technical specification

Type	Qty.	Order No.
M-PRINT PRO	1	1905490000



Accessories - STI pen

Technical specification

Ordering data

Type	Qty.	Order No.
Adapter aluminium STI pen	1	1762440000
STI pen SW	10	0508401694

The STI-S felt tip pen is suitable for labelling blank Weidmüller marking products. It can be used for handwritten labels or, in conjunction with the STI-S adapter, for a plotter printout. A black, waterproof ink is used.

MC-Mobilo

The MC-Mobilo allows users to work directly at place. There is no need for a PC and no need for a power supply so electrical equipment can be labelled anywhere, anytime. The rechargeable battery provides power for up to 3 hours. The universal inlay enables up to 120 different marker types of the MultiCard range to be processed.



Technical data

Type	Plotter
Application	Printing of MultiCard markers
Technology	Plotting technique
Print software	WM-Print
Interface	RS 232
Power supply	AC 230 / AC 115 V
Feed	manual
Location	can be used anywhere
Ambient temperature	15 – 30 °C
Dimensions (L x W x H)	380 x 190 x 68 mm
Weight	3 kg
Scope of supply	MC-Mobilo, universal power unit, including adapters (EURO, UK, USA), data cassette, operating instructions, PowerPack, PC connecting cable, WM-Print, universal MultiCard mounting frame, 0.25 mm plotter pen, carry case

Ordering data

MC-Mobilo

	Qty.	Order No.
MC-Mobilo		
MC-Mobilo 110/220 V	1	1741260001
MC-Mobilo Accessories		
Printkit (Ink 2000, Clean 2000, Plotter-Pen 0,25)	1	1686920000
Frame inlay SF 4-6	1	1802180000
Accessories Plotter IP220/MC-Mobilo		
P-Ink	1	1924340000
Ink 2000 25 ml	1	1772120000
P cleaner	1	1924330000
Cleaner Clean 2000 25 ml	1	1772130000
Plotter pen 0.18	1	1768570000
Plotter pen 0.25	1	1768540000
Plotter pen 0.25 P-Ink	1	1920640000
Plotter pen 0.35	1	1768550000
Plotter pen 0.35 P-Ink	1	1920650000
Plotter pen 0.50	1	1768560000
Plotter pen 0.50 P-Ink	1	1005710000
Plotter pen 0.70	1	1011440000
Plotter pen 0.70 P-Ink	1	1011450000
Accessories – STI pen		
Adapter aluminium STI pen	1	1762440000
STI pen SW	10	0508401694

M-Print® PRO Label Designer

Print and ordering software for markers and labels

M-Print® PRO is a professional software for printing and ordering Weidmüller markers and labels under Windows®. This software helps you to optimise your processes for marking electrical equipment. You can design, print and order your marking materials effortlessly, professionally and quickly: texts, frames, lines, graphics, barcodes, serial numbers and photos.

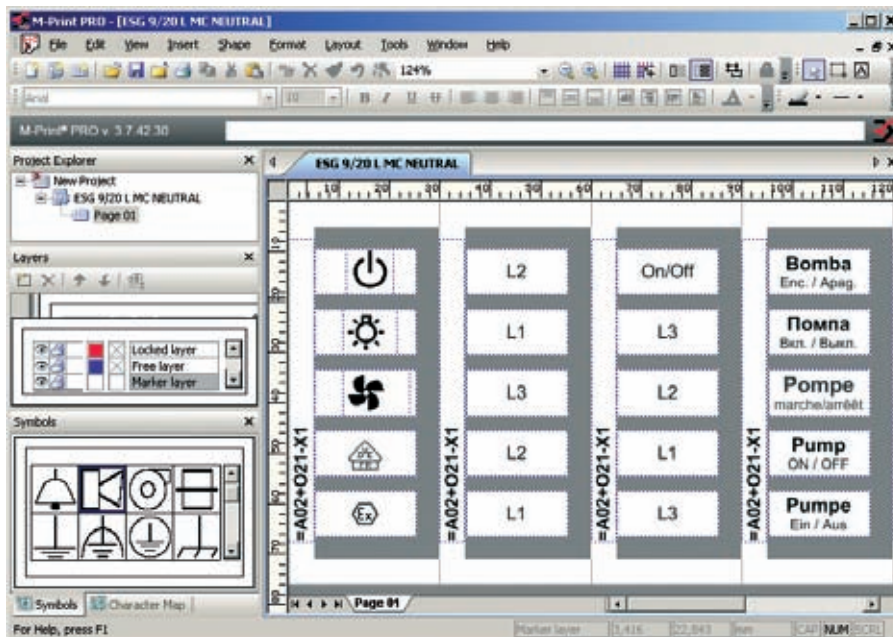

Technical data

Here is an overview of the main functions

- Integrated product catalogue for all labels and markers, including images and links to the relevant web pages and product data sheets
- Markers and labels can be designed in as many levels as required
- Custom formatting of individual text characters (RTF)
- Perform copy-and-paste functions with texts and their formats
- Supports UNICODE for foreign-language texts, such as Russian, Chinese, Polish, etc.
- Enter data on labels or worksheet
- Permanent print preview: see how the printout will look during the design phase
- Alphanumeric counts and sequences
- Extensive range of image formats (*.bmp, *.wmf, *.png, *.ico, *.jpeg, *.tif, *.gif)
- Image library including all the important symbols used in electrical engineering
- Assign product to specific printer; for example, ESG 9/20 to PrintJet, LaserMark to laser printer, etc.
- Output devices supported: PrintJet I+II, SMark-Laser, ThermoCard, THM as well as standard printers with Windows drivers, plotter MCP Plus
- Optimum and rapid adjustment of the output devices
- Online update service via the Internet
- Interface to RailDesigner®
- Import assistant to create your own import filter for numerous file formats (*.txt, *.asc, *.mak, *.wei, *.tmf, etc.)
- Imports data from CAE systems

Operating systems supported

WINDOWS® 2000/XP/Vista

System requirements

RAM	> 64 MB
Processor	> Pentium PIII or comparable model
Graphics	> 800 x 600 pixels with 256 colours optimum: 1024 x 768 with 16-bit High Colour
Hard drive	> 90 MB free storage
Miscellaneous	mouse, keyboard, CD-ROM drive (to install the software)

M-Print® PRO is available in two editions:

M-Print® PRO Standard Edition for professional printing results with all of Weidmüller's marking materials

M-Print® PRO Advanced Edition for professional printing results with all of Weidmüller's marking materials plus labels to customer specification

Ordering data

M-Print® PRO

Type	Order No.
M-Print® PRO	1905490000
M-Print® PRO advanced	1905500000

Technical appendix

Technical appendix

Certificates	W.2
Electrical data	
Insulating materials	W.4
Design of clearances and creepage distances in electrical equipment – influencing factors	W.6
General technical information	
IP class of protection to DIN EN 60529	W.8
Conversion table for AWG to mm ² conductors	W.9
Installation instructions	
Connecting the terminals	W.10
The use of aluminium conductors	W.11
Connection system	
Free choice of connection technology	W.12
Terminals	
Regulations / definitions	W.14
The assembly of terminals rails	W.15
Definitions of the various terminal types	W.16
ATEX	
ATEX terminals	W.18
ATEX directives	W.20
ATEX codes	W.21
ATEX cross-connection instructions	W.22

Materials

Insulating materials

In order to always deliver to you first-class products, quality control is of the utmost importance to us. Beginning with our product quality management under ISO 9000 ff., and extending to the continuous monitoring by independent institutes. These control our production facilities, our quality management and our own laboratory. And so we benefit from total reliability and longevity!

Accredited testing laboratories

The reliability of the technical data is of the utmost importance to the user. Our lab has DIN EN ISO/IEC accreditations from an external independent institution (the German Accreditation Body for Technology GmbH). This enables our lab to carry out certified tests for terminal blocks, connectors, and electronic equipment – including EMC and environmental impact tests. And so you can be sure that our products can be used throughout the world.

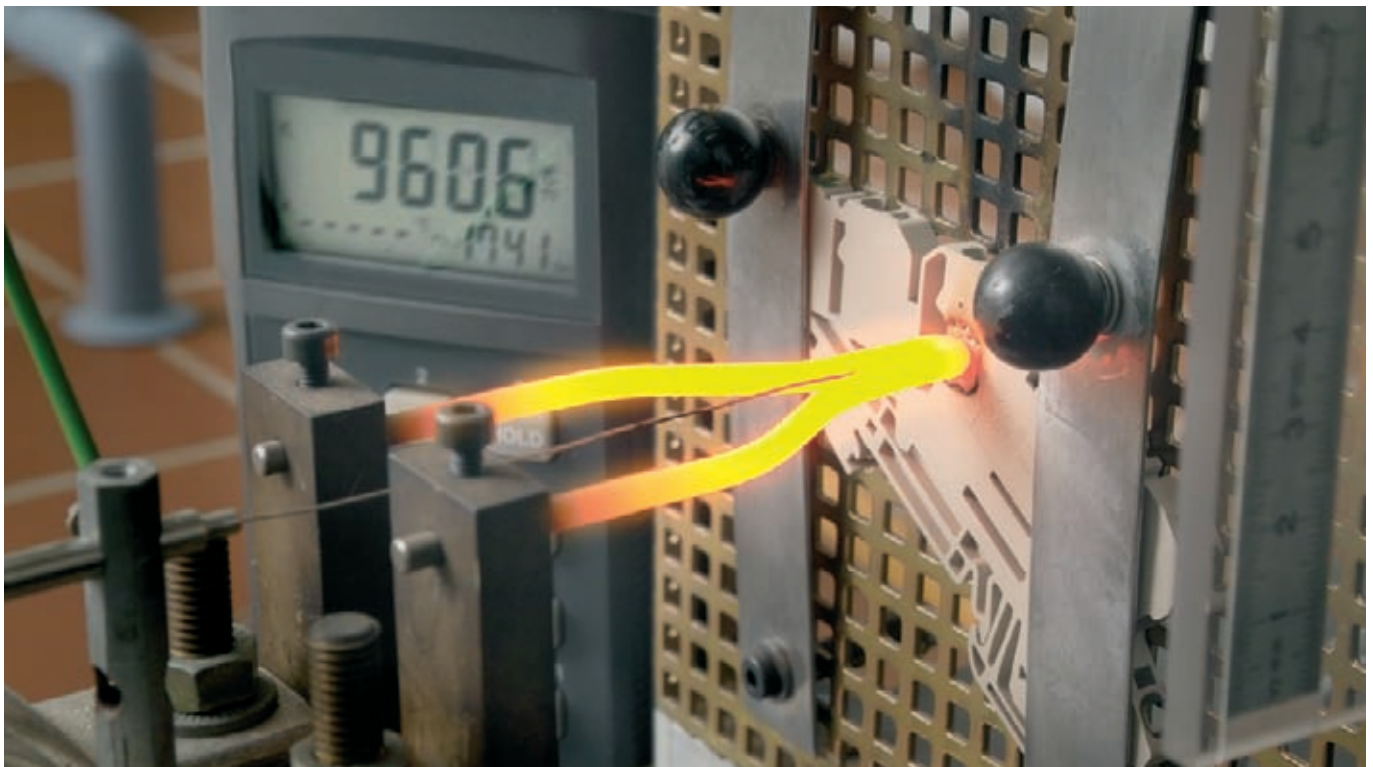

Product approvals

Approvals are proof of the quality of our products. The approvals are granted following performance tests carried out by independent institutions, and are the prerequisite for product use in certain markets or fields of applications.



Certifications

Quality management in the Weidmüller group of companies is based on ISO 9000 ff. Certified verification by accredited certification bodies makes it easier for you to judge suppliers.







Insulating materials

In order to do justice to the most diverse requirements placed on our products, it is necessary to use different insulating materials tailored to the needs of the applications. None of the insulating materials used by Weidmüller contain any hazardous substances. Above all, the use of cadmium-free materials is very high on our agenda. Furthermore, our insulating materials contain neither pigments based on heavy metals nor any substances that lead to the formation of dioxin or furan.

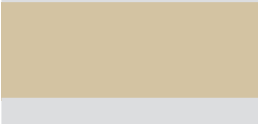
	Ceramics	Thermosetting plastics	
Plastic Abbreviation	Ceramics	Gemin KrG	Epoxy resin EP
	Ceramics are excellent materials for electrical engineering because they fulfill all the requirements. Ceramics are resistant to heat, fluids and sparks, and are tested for leakage currents. Thanks to their high mechanical strength, low losses and good heat resistance, these materials have a very high chemical stability and are preferred because of their very low wear.	Thermosetting plastics exhibit high dimensional stability, low water absorption, extremely good tracking resistance and excellent fire resistance.	The continuous operating temperatures are higher than those of thermoplastics. At higher thermal loads the deformation resistance of thermosetting plastics is better than that of thermoplastics.
	Insulating material	Melamine resin moulding compound, MF type 150 (DIN EN ISO 14 528) inorganic filler	Epoxy resin with inorganic filler
Colour	white	medium yellow	black
			
Description	highest continuous operating temperature high fire resistance fluids-repellent high tracking resistance inherently flame-retardant	high continuous operating temperature high fire resistance high tracking resistance inherently flame-retardant halogen-free flame-retardant agent	very good electrical properties very high continuous operating temperature resistant to high-energy radiation halogen- and phosphor-free flame-retardant agent
Properties			
Specific volume resistance to IEC 60093	$\Omega \times \text{cm}$	-	10^{11}
Electric strength to IEC 60243-1	kV / mm	>10	10
Tracking resistance (A) to IEC 60112	CTI	≥ 600	≥ 600
Upper max. permissible temperature	°C	250	130
Lower max. permissible temperature, static	°C	-60	-60
Flamability class to UL 94		V-0 (5 V-B)	V-0 (5 V-A)
Fire behaviour to railway standard			

Thermoplastics

Wemid	Polyamide PA	Polyamide PAGF	Polybutylene-terephthalate PBT	Polycarbonate PC
<p>Wemid is a modified thermoplastic whose properties have been specially devised to suit the requirements of Weidmüller connectors. The advantages in comparison with PA are the better fire protection and the higher continuous operating temperature. Wemid fulfils the strict requirements placed on applications for railway rolling stock to NF F 16-101.</p>	<p>Polyamide (PA) is one of the most common commercial plastics. The advantages of this material are its very good electrical and mechanical properties, its flexibility and resistance to breakage. Furthermore, owing to its chemical structure PA achieves good fire resistance even without the use of flame-retardant agents.</p>	<p>Glass fibre-reinforced polyamide (PAGF) offers excellent dimensional stability and very good mechanical properties. That makes this material ideal for use in end brackets. Compared with unreinforced PA, this material can achieve UL 94 flammability class HB.</p>	<p>This thermoplastic polyester (PBT) offers excellent dimensional stability (and is therefore ideal for plug-in connectors) and a high continuous operation temperature. But the tracking resistance is lower than other insulating materials.</p>	
special Weidmüller insulating material	insulating material	insulating material	with or without glass fibre reinforcement depending on application	with or without glass fibre reinforcement depending on application
dark beige	beige	beige	orange	grey
				
<p>higher continuous operating temperature</p> <p>improved fire resistance</p> <p>halogen- and phosphor-free flame-retardant agent</p> <p>flame-retardant agent low smoke development in fire</p> <p>certified for railway applications to NF F 16-101</p>	<p>flexible, virtually unbreakable</p> <p>good electrical and mechanical properties</p> <p>self-extinguishing behaviour</p> <p>halogen-free flame-retardant agent</p>	<p>excellent dimensional stability</p> <p>very good mechanical properties</p> <p>halogen-free flame-retardant agent</p>	<p>high dimensional stability</p> <p>good electrical and mechanical properties</p> <p>flame-retardant substances do not lead to the formation of dioxin or furan</p>	<p>high dimensional stability</p> <p>high continuous operating temperature</p> <p>high electrical insulation capacity</p> <p>halogen-free flame-retardant agent</p>
<p>10¹²</p> <p>25</p> <p>600</p> <p>120</p> <p>-50</p> <p>V-0</p> <p>I2 / F2 *)</p>	<p>10¹²</p> <p>30</p> <p>600</p> <p>100</p> <p>-50</p> <p>V-2</p>	<p>10¹²</p> <p>30</p> <p>500</p> <p>100</p> <p>-50</p> <p>HB</p>	<p>10¹³</p> <p>28</p> <p>200</p> <p>115 / 130</p> <p>-50</p> <p>V-0</p>	<p>10¹⁶</p> <p>≥ 30</p> <p>≥ 175</p> <p>115 / 125</p> <p>-50</p> <p>V-2 / V-0</p> <p>I2 / F2</p>
<p>*) also certified to LUL E 1042</p>				

Design of clearances and creepage distances in electrical equipment – influencing factors

Rated impulse withstand voltage

The rated impulse withstand voltage is derived from:

- **Voltage conductor – earth**
(the rated voltage of the network, taking into account all networks)
- **Surge category**

Table 1: Rated impulse withstand voltages for electrical equipment

Rated voltage of power supplies system *) in V		Rated impulse withstand voltage in kV			
Three-phase systems	Single-phase systems with neutral point	Electrical equipment at the supplies point of the installation (Surge category IV)	Electrical equipment as part of the permanent installation (Surge category III)	Electrical equipment to be connected to the permanent installation (Surge category II)	Specially protected electrical equipment (Surge category I)
	120 to 240	4.00	2.50	1.50	0.80
230/400 277/480		6.00	4.00	2.50	1.50
400/690		8.00	6.00	4.00	2.50
1000		Values depend on the particular project of, if no values are available, the values of the preceding line apply.			
*) to IEC 38					

Surge categories

are stipulated in accordance with the German standard DIN VDE 0110-1 (for electrical equipment fed directly from the low-voltage network).

Surge category I

- Equipment that is intended to be connected to the permanent electrical installation of a building. Measures to limit transient surges to the specific level are taken outside the equipment, either in the permanent installation or between the permanent installation and the equipment.

Surge category II

- Equipment to be connected to the permanent electrical installation of a building, e.g. household appliances, portable tools, etc.

Surge category III

- Equipment that is part of the permanent electrical installation and other equipment where a higher degree of availability is expected, e.g. distribution boards, circuit-breakers, wiring systems (including cables, busbars, junction boxes, switches, power sockets) in the permanent installation, and equipment for industrial use and some other equipment, e.g. stationary motors with permanent connections to the permanent installation.

Surge category VI

- Equipment for use at or near the power supplies in the electrical installations of buildings, between the principal distribution and the mains, e.g. electricity meters, circuit-breakers and centralised ripple controllers.

Pollution severity categories

Pollution severity category 1

- No pollution, or only dry, non-conductive pollution that has no influence.

Pollution severity category 2

- Non-conductive pollution only; occasional condensation may cause temporary conductivity.

Pollution severity category 3

- Conductive pollution, or dry, non-conductive pollution that is liable to be rendered conductive through condensation.

Pollution severity category 4

- Contamination results in constant conductivity, e.g. caused by conductive dust, rain or snow.

Unless explicitly stated otherwise, the dimensioning of clearance and creepage distances and the resulting rating data for electromechanical products (terminals, terminal strips, PCB connection terminals and plug-in connectors) is based on pollution severity 3 and surge category III, taking account of all network types.

Design of clearances and creepage distances in electrical equipment – influencing factors

Rated voltage

The rated voltage is derived from the nominal voltage of the power supply and the corresponding network type.

Single-phase 2- or 3-wire AC or DC systems

Rated voltage of the power supply (mains) ¹⁾	Voltages for table 4	
	For insulation phase-to-phase ¹⁾	For insulation phase-to-earth ¹⁾
	All systems	3-wire systems neutral pt. earthing
V	V	V
12.5	12.5	–
24 / 25	25	–
30	32	–
42 / 48 / 50 ^{**)}	50	–
60	63	–
30–60	63	32
100 ^{**)}	100	–
110 / 120	125	–
150 ^{**)}	160	–
220	250	–
110–220	250	125
120–240	–	–
300 ^{**)}	320	–
220–440	500	250
600 ^{**)}	630	–
480–960	1000	500
1000 ^{**)}	1000	–

3-phase 3- or 4-wire AC systems

Rated voltage of the power supply (mains) ¹⁾	Voltages for table 4		
	For insulation phase-to-phase	For insulation phase-to-earth	
	All systems	3-phase 4-wire systems with earthed neutral wire ²⁾	3-phase 3-wire systems unearthed ¹⁾ or phase-earthed
V	V	V	V
60	63	32	63
110/120/127	125	80	125
150 ^{**)}	160	–	160
208	200	125	200
220/230/240	250	160	250
300 ^{**)}	320	–	320
380/400/415	400	250	400
440	500	250	500
480/500	500	320	500
575	630	400	630
600 ^{**)}	630	–	630
660/690	630	400	630
720/830	800	500	800
960	1000	630	1000
1000 ^{**)}	1000	–	1000

1) Phase-to-earth insulation levels for unearthed or impedance-earthed systems are equal to those of phase-to-phase because the operating voltage to earth of any phase can, in practice, reach full phase-to-phase voltage. This is because the actual voltage to earth is determined by the insulation resistance and capacitive reactance of each phase to earth; thus, a low (but acceptable) insulation resistance of one phase can earth it and raise the other two to full phase-to-phase voltage to earth.

2) For electrical equipment for use in both 3-phase 4-wire and 3-phase 3-wire supplies, earthed and unearthed, use the values for 3-wire systems only.

*) It is assumed that the rated voltage of the electrical equipment is not lower than the nominal voltage of the power supply.

**) Because of the common changes, the meaning of the ** symbol has not been used in table 1; i.e. the / symbol indicates a 4-wire 3-phase distribution system. The lower value is the phase-to-neutral voltage, while the higher value is the phase-to-phase voltage. Where only one value is indicated, it refers to 3-wire 3-phase systems and specifies the value phase-to-phase. The values given in table 1 are still taken into account in tables 3a and 3b by the ** symbol.

Insulating material group

The insulating materials are divided into four groups depending on the comparative figures for creepage distance (CTI = comparative tracking index):

Insulating material group

I	$600 \leq \text{CTI}$
II	$400 \leq \text{CTI} < 600$
III a	$175 \leq \text{CTI} < 400$
III b	$100 \leq \text{CTI} < 175$

The comparative tracking index must be determined using special samples produced for this purpose with test solution A in compliance with IEC 60112 (DIN IEC 60112/DIN VDE 0303-1).

IP class of protection to DIN EN 60529

The ingress protection class or IP rating is indicated by a code consisting of the two letters IP and two digits representing the class of protection.

Example: **IP 65**
 | 2nd digit: protection from liquids
 | 1st digit: protection from solid bodies

Protection against intrusion of external particle matter (1st digit)

ID number		
0		No protection
1		Protection against ingress of large solid bodies with diameter > 50 mm. (Protection to prevent dangerous parts being touched with the back of the hand.)
2		Protection against ingress of large solid bodies with diameter > 12.5 mm. (Protection to prevent dangerous parts being touched with the fingers.)
3		Protection against ingress of large solid bodies with diameter > 2.5 mm. (Protection to prevent dangerous parts being touched with a tool.)
4		Protection against ingress of large solid bodies with diameter > 1 mm. (Protection to prevent dangerous parts being touched with a piece of wire.)
5		Protection against harmful deposits of dust, which cannot enter in an amount sufficient to interfere with satisfactory operation.
6		Complete protection against ingress of dust.

Protection against penetration of liquids (2nd digit)

ID number		
0		No protection
1		Protection against drops of condensed water falling vertically.
2		Protection against drops of liquid falling at an angle of 15° with respect to the vertical.
3		Protection against drops of liquid falling at an angle of 60° with respect to the vertical.
4		Protection against liquids splashed from any direction.
5		Protection against water jets projected by a nozzle from any direction.
6		Protection against water from heavy sea on ships' decks.
7		Protection against immersion in water under defined conditions of pressure and time.
8		Protection against indefinite immersion in water under defined conditions of pressure (which must be agreed between manufacturer and user and must be more adverse than number 7).

Conversion table for AWG to mm² conductors

AWG

AWG is the abbreviation for „**A**merican **W**ire **G**auge“. This designation bears no resemblance to the actual cross-section of the conductor.

The relationship between AWG and mm² is shown in the following table.

AWG	mm ²
28	0.08
26	0.13
24	0.21
22	0.22
20	0.52
19	0.65
18	0.82
17	1.04
16	1.31
15	1.65
14	2.08
13	2.63
12	3.31
11	4.17
10	5.26
9	6.63
8	8.37
7	10.55
6	13.30
5	16.77
4	21.15
3	26.67
2	33.63
1	42.41
0	53.48

Plug gauge to IEC 60947-1

Insertion of unprepared round conductors with the largest prescribed cross-section

Test with defined gauge, insertion simply under self-weight



Conductor cross-section		Plug gauge						
Flexible conductor mm ²	Rigid conductor (solid or stranded) mm ²	Form A			Form B			Permissible deviation for a and b mm
		Designation	Diameter a mm	Width b mm	Designation	Diameter a mm		
1.5	1.5	A 1	2.4	1.5	B 1	1.9	0 – 0.05	
2.5	2.5	A 2	2.8	2.0	B 2	2.4		
2.5	4	A 3	2.8	2.4	B 3	2.7		
4	6	A 4	3.6	3.1	B 4	3.5	0 – 0.06	
6	10	A 5	4.3	4.0	B 5	4.4		
10	16	A 6	5.4	5.1	B 6	5.3		
16	25	A 7	7.1	6.3	B 7	6.9	0 – 0.07	
25	35	A 8	8.3	7.8	B 8	8.2		
35	50	A 9	10.2	9.2	B 9	10.0		
50	70	A 10	12.3	11.0	B 10	12.0	0 – 0.08	
70	95	A 11	14.2	13.1	B 11	14.0		
95	120	A 12	16.2	15.1	B 12	16.0		
120	150	A 13	18.2	17.0	B 13	18.0		

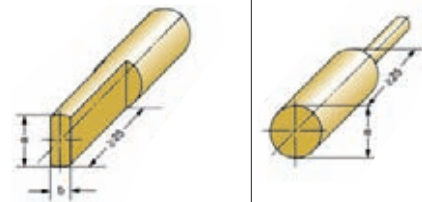

Connecting the terminals

Cross-connections systems

Weidmüller can supply the cross-connections WQV and ZQV – fully insulated against electric shock – with various numbers of poles (2- to 20-pole). Please note that the rated voltage is reduced when using cross-connections.

Protection against electric shock is not provided at the ends of shortened cross-connections.

Such cross-connections must be used with partition plates or end plates in order to maintain the rated voltage.

Leaf clamp conductor connection for large cross-sections

It is no longer the case that conductors with large cross-sections have to be forced into the clamping point. Instead, they can now be easily laid in the modular terminal.

In addition to the individual form, every type of terminal can also be supplied in the form of 3-, 4- and 5-pole blocks. All the blocks are permanently screwed together and therefore guarantee additional rigidity.

Direct mounting is possible thanks to the elongated holes on the underside of the terminals. Terminal blocks can be screwed directly to mounting plates with a 25 mm pitch.

The other advantages are:

- Constant force transfer through self-adjusting connection system
- Mounting in any direction
- Electric shock protection (finger-proof) to German standard VBG 4, also with cross-connections
- Extremely resistant to distortion



Open cover and remove screw assembly.



Insert conductor and replace screw assembly.



Close cover and tighten screw with Allen key.

The use of aluminium conductors

Weidmüller modular terminals are suitable for the direct connection of **solid round and sector aluminium conductors**.

In contrast to copper, aluminium exhibits certain characteristics that must be taken into account when using this material as a conductor in electrical engineering.

A thin, non-conductive layer of oxide forms immediately on the unprotected surface of the aluminium as soon as it is exposed to the air.

This layer increases the contact resistance between the aluminium conductor and the current bar of the modular terminal. And that, in unfavourable conditions, can lead to poor contact.

And in stranded conductors the contact resistances of the individual strands are added together. Despite these disadvantages, aluminium conductors can be connected to Weidmüller modular terminals, provided the reduced rated currents for aluminium conductors and the following installation conditions are adhered to.

1. Scrape the stripped end of the conductor carefully, eg. with a knife, to remove the layer of oxide.

Caution: Do not use brushes, files or emery paper because particles of aluminium can be deposited on other conductors.

2. After removing the layer of oxide, coat the end of the conductor immediately with a neutral grease, e.g. acid- and alkali-free Vaseline, and connect it to the terminal immediately.

3. Repeat the above procedure if at any time the conductor is disconnected and reconnected.

4. The above installation instructions are valid for solid round or sector aluminium conductors only.

Solid round and sector conductors

Terminal type	Rated cross-section	Reduced rated current when connecting an aluminium conductor	Clamping screw thread size	Tightening torque
W-Series	mm ²	„A“		Nm
WDU 2.5	2.5	20	M 2.5	0.5-0.8
WDU 4	4	27	M 3	0.6-1.0
WDU 6	6	35	M 3.5	1.2-1.6
WDU 10	10	48	M 4	2.0-2.4
WDU 16	16	64	M 5	3.0-4.0
WDU 35	35	105	M 6	4.0-6.0
WDU 70	70	163	M 8	10.0-12.0
WDU 120	120	230	M 10	15.0-20.0
WDU 240	240	–	M 10	12.0-20.0
SAK-Series				
SAK 2.5	2.5	20	M 2.5	0.5-0.8
SAK 4	4	27	M 3	0.6-1.0
SAK 6	6	35	M 3.5	1.2-1.6
SAK 10	10	48	M 4	2.0-2.4
SAK 16	16	64	M 4	2.0-2.4
SAK 35	35	105	M 6	4.0-6.0

Stranded conductors

W-Series				
Terminal type	Rated cross-section	Reduced rated current	Clamping screw thread size	Tightening torque
WFF 35	35	105	M 6	3.0-6.0
WFF 70	70	163	M 8	6.0-12.0
WFF 120	120	230	M 10	10.0-20.0
WFF 185	185	300	M 12	15.5-31.0
WFF 300	300	409	M 16	30.0-60.0

Installation advice when using flat cable lugs

When tightening the terminal it is advisable to hold the conductor to prevent deformation of the terminal rail and to avoid twisting the foot of the terminal. When connecting **stranded aluminium conductors** to modular terminals, it is advisable to use an aluminium cable lug chosen to match the type of conductor and connected according to the instructions of the cable lug manufacturer. It is

necessary to fit a copper-plated aluminium washer between the aluminium cable lug and the copper current bar of the modular terminal. This is the only way of guaranteeing a reliable transition between the copper and the aluminium. Fit the washer in such a way that the copper side is in contact with the current bar, and the aluminium side in contact with the cable lug.

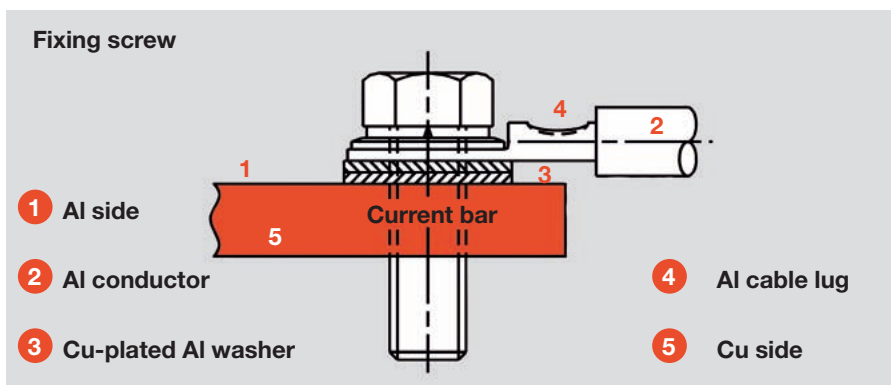

Free choice of connection technology

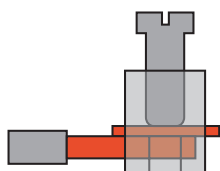

Clamping yoke connection technology

The **Weidmüller clamping yoke system** is an optimum combination of the specific properties of steel and copper. This clamping yoke system has proved its worth in billions of Weidmüller products over many decades. Both the clamping yoke and the clamping screw are made from hardened steel. This clamping yoke arrangement generates the necessary contact force. The clamping yoke presses the incoming conductor against a current bar made of copper or high-quality brass. The hardened Weidmüller clamping yoke ensures a gas-tight, vibration-resistant connection between conductor and current bar.

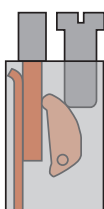

TOP connection technology

The Weidmüller **TOP connection system** ensures that the conductor can be inserted and the clamping screw tightened from the same direction. Such an arrangement eases the wiring work in certain installations, e.g. when there is little space at the sides in terminal boxes. The TOP connection system combines the specific properties of steel and copper. The hardened steel lever presses the conductor directly against a current bar made of copper or high-quality brass. The high contact force guarantees a gas-tight connection between conductor and current bar.

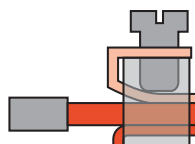

Leaf spring connection technology

Weidmüller's patented **leaf clamp connection system** is a screw connection system for large conductor cross-sections. The insertion of large conductors into the clamping point is made easier here by the fact that the clamping unit can be removed first. The conductor can then be placed directly on the current bar before re-inserting the clamping unit and tightening the screw to grip the conductor.

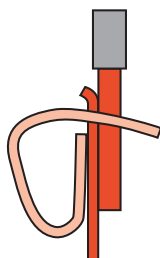

Tension clamp connection technology

The **Weidmüller tension clamp system** functions similarly to the tried-and-tested clamping yoke. Here again, the mechanical and electrical functions are kept separate. The spring made from high-quality rustproof and acid-proof steel pulls the conductor against the tin-plated copper current bar. Treating the copper in this way ensures low contact resistance and high corrosion resistance. The compensating effect of the spring ensures a secure contact for the lifetime of the terminal.

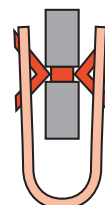

IDC connection technology

The **IDC connection technology** (Insulation Displacement Connection) is a type of connection for copper conductors that does not require the conductor to be prepared in any way – so no stripping and no crimping.

When connecting the conductor, the insulation of the conductor is penetrated and an electrically conductive contact between conductor and current bar produced at the same time.

The Weidmüller IDC principle, like Weidmüller's other types of connection, again keeps mechanical and electrical functions separate.

A spring made from rustproof stainless steel presses the current bar onto the conductor and therefore guarantees a low contact resistance and a gas-tight, vibration-resistant connection.

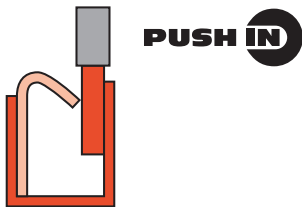

Push In-Connection technology

In the **Push In connection technology** the stripped solid conductor is simply inserted into the clamping point as far as it will go. And that completes the connection! No tools are required and the result is a reliable, vibration-resistant and gas-tight connection. Even flexible conductors with crimped wire end ferrules or ultrasonic-welded conductors can be connected without any problems. A stainless steel spring, which is fitted in a separate housing, guarantees a high contact force between the conductor and the current bar (tin-plated copper). The conductor pull-out force for this system is even higher than that for the tension clamp system. Spring stop plus conductor stop in a steel housing ensure optimum connection conditions and a guide for the screwdriver needed to detach the conductor.

The principle of vibration resistance

Clamping yoke

As the clamping screw is tightened, the ensuing force causes the upper threaded part to spring back and exert a locknut effect on the screw. The Weidmüller clamping yoke system is vibration-resistant. The relaxation of the conductor is compensated for by the elastic behaviour of the Weidmüller clamping yoke. It is therefore not necessary to retighten the clamping screw.

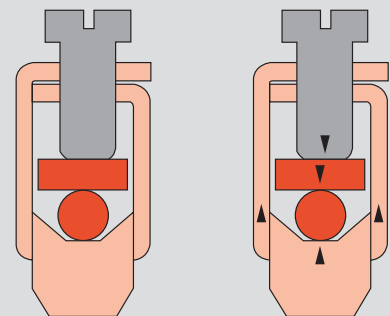

Leaf clamp

The distance “d” between the shaft of the clamping screw and the leaf clamp causes elastic deformation of the spring as the screw is tightened. The vibration resistance depends on the magnitude of the spring force of the leaf clamp, and this force also compensates for relaxation phenomena in the conductor. It is therefore not necessary to retighten the clamping screw.

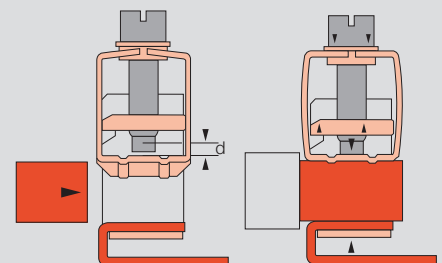

TOP

Like with the clamping yoke, the force exerted by the steel lever as the screw is tightened forces apart the two threaded parts of the TOP connection. This exerts a locking effect on the screw and guarantees excellent vibration resistance.

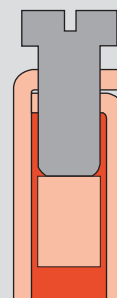

Regulations / definitions

Terminals acc. to VDE 0611-1

This standard was published in Germany in August 1992:

VDE 0611-1 Low-voltage switchgear part 7: Ancillary equipment section 1 – Terminal blocks for copper conductors.

The contents of this standard correspond to the international standard:

IEC 60947-7-1:

1989 Low voltage switchgear and control gear part 7: Ancillary equipment section 1 – Terminal blocks for copper conductors

At the European level this standard has been ratified by CENELEC, making it valid in the following countries:

Austria, Belgium, Denmark, Finland, France, Germany, Greece, Holland, Iceland, Ireland, Italy, Luxembourg, Norway, Portugal, Spain, Sweden, Switzerland, United Kingdom

Combined application in order of priority:

IEC 60947-1

Low-voltage switchgear and control gear part 1: General Rules EN 60947-1

VDE 0660 part 100

Low-voltage switchgear part 1:

General Rule

Scope VDE 0611-1

(EN 60947-7-1)

(IEC 60947-7-1)

This standard stipulates the requirements for terminals with screwed or screwless terminal strips intended primarily for industrial or similar use, with the terminals fastened to a carrier to produce both electrical and mechanical connections between copper conductors. It applies to terminals used for connecting round copper conductors with a cross-section between 0.2 mm² and 300 mm² (AWG 24/600 kcmil), and for electronic circuits up to 1000 V AC 1000 Hz or up to 1500 V DC.

Remarks:

This standard is also used as guide for special kinds of terminals (e.g. isolating terminals) for which no special standards are available.

Terminals/ feed-through terminals

An insulating part which carries one or several mutually insulated terminal arrays intended for fastening to a carrier.

Rated cross-section

The rated cross-section of a terminal is the cross-section of the conductor to be connected by the terminal as stated by the manufacturer. It is determined by certain thermal, mechanical and electrical requirements, and is one of the specifications marked on the terminal.

The rated cross-section is selected from the following standard cross-sections: 0.2 - 0.5 - 0.75 - 1.0 - 1.5 - 2.5 - 4.0 - 6.0 - 10 - 16 - 25 - 35 - 50 - 70 - 95 - 120 - 150 - 240 - 300 mm².

The terminals have a rated connection capability, which is at least two stages smaller than the rated cross-section. The conductors may be solid, stranded or flexible and, if necessary, may have their ends pre-treated. The rated cross-section is verified using the gauges stipulated by VDE 0660 part 100 table 7 (see page W.14).

Rated current

Each rated cross-section is assigned a particular test current stipulated by VDE 0611-1. At these rated currents, terminals are not subject to non-permissible increases in temperature:

mm ²	1.5	2.5	4.0	6.0
A	17.5	24	32	41
mm ²	10	16	25	35
A	57	76	101	125
mm ²	50	70	95	120
A	150	192	232	269
mm ²	150	185	240	300
A	309	353	415	520

Rated voltage

VDE 0611-1 / VDE 0660 part 100

The rated voltage of a terminal is the rated insulation voltage to which the insulation tests and creepage distances refer. It is defined analogously to DIN VDE 0110-1, and is one of the specifications marked on the terminal.

Rated surge voltage

DIN VDE 0110-1 / VDE 0660 part 100

Peak values of a surge voltage which can be applied to the terminals and to which the clearance distances acc. to VDE 0660 part 100 or DIN VDE 0110-1 refer.

Degree of soiling

DIN VDE 0110-1 / VDE 0660 part 100

The degree of soiling stipulates the influence of solid, liquid or gaseous foreign particles, which may reduce the dielectric strength or specific surface resistance (see also page W.5).

Terminals for use in the industrial field of application are assigned degree of soiling 3: either conductive contamination may occur or, alternatively, dry, non-conductive contamination which becomes conductive in the likely event of condensation.

The minimum clearance distance is stipulated in combination with the rated surge voltage in VDE 0660 part 100 or DIN VDE 0110-1.

The assembly of terminal rails

Operating conditions

Terminals can be operated under the following normal conditions:

- Ambient temperature $-5\text{ °C} \dots +40\text{ °C}$, mean temperature 24 h $+35\text{ °C}$
- Altitude up to 2000 m a.s.l.
- Relative humidity 50 % at $+40\text{ °C}$, 90 % at 20 °C .

CE mark

A EU directive stipulates that labelling with the CE mark is carried out by the manufacturer. The mark indicates to the state authorities that the item complies with the relevant directives. It thus guarantees free trade within Europe.

Conductor connectors from $\geq 50\text{ V} \sim / 75\text{ V}$ comply with the basic safety requirements stated in the low-voltage directive 73/23/EEC (amended by 93/68/EEC). CE marking acc. to the marking directive 93/68/EEC has been mandatory since 1 January 1997.

It is affixed to the packaging.

Declarations of conformity are kept available for inspection by the relevant national supervisory agencies as part of the technical documentation.

Mounting and end brackets

- Terminal strips mounted from left to right
- Closed side on the left, open side on the right
- Open side of the terminal always closed using end plates or partition plates (WAP/TW; ZAP/TW and IAP)
- End brackets placed at the beginning and end of the terminal strip
- End bracket not required next to PE terminals. Exceptions: WDK/PE and ZPE

Combinations of different terminals

- End plates or partition plates (WAP/TW, ZAP/TW and IAP) must be used when the contour changes.
- For adjacent terminals with differing rated voltages, end plates or partition plates (WAP/TW, ZAP/TW and IAP) must be used in order that the respective rated voltages are adhered to.
- When the PE terminal is positioned next to or between corresponding feedthrough terminals of the same series and size, this does not influence the rated voltage or rated surge voltage of the feed-through terminals.

Dimensions

The overall dimensions of the terminals with fastening parts are stipulated, but without tolerances. A mounting tolerance of 0.2 mm must be added to the terminal width when planning projects.

Partition plate

The partition plate is necessary for visual separation of circuits or for electrical separation of neighbouring crossconnections.

Partition disc

Partition discs can be retrofitted between cross connectors or sockets in terminals up to a max. terminal width of 12 mm.

Compliance with the rated insulation voltage

The required stripping length for every Weidmüller product is stated in mm. These lengths, such as $< 6\text{ mm} \pm 0.5\text{ mm}$, $> 10\text{ mm} \pm 1\text{ mm}$, must be adhered to. This also applies when using ferrules. The external dimensions of crimped ferrules must comply with IE 60947-1 (1999 version).

Working on electrical connection elements with non-insulated screwdrivers

Work using non-insulated screwdrivers may only be carried out in disconnected systems.

The following five safety rules must be observed when disconnecting a system before beginning work and in order to ensure the system remains disconnected at the working site for the duration of this work:

- **Disconnect**
- **Secure to prevent the system from being switched on again**
- **Ascertain that the system is not live**
- **Earth and short circuit the system**
- **Cover or cordon off any neighbouring live parts**

These five rules constitute the safety precautions for working with electrical systems and equipment. The measures to be taken in accordance with operating and local conditions, e.g. for high- and low-voltage overhead lines, cables or switchgear, are stipulated in detail in VDE 0105 part 100.

Live terminals which are not in use

Any terminals which are not in use and which could carry live voltage are to be fitted with suitable covers (e.g. ADP 1...4) to prevent them from being inadvertently touched. The clamping screws of terminals, which are not in use, even those that are not live, are to be screwed tight.

VDE 0105 part 100

Operation of electrical installations: Work

Troubleshooting with two-pole voltage detectors including voltage tester acc. to IEC 61243-3.

Definitions of the various terminal types

PE terminals

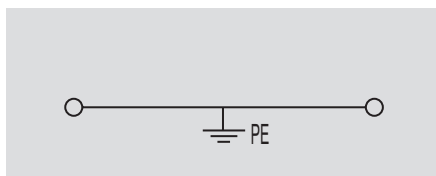

A PE terminal is a component with one or several clamping points for connecting and/or branching PE conductors (PE and PEN conductors) with a conductive connection to their mountings. Partly insulated PE terminals are insulated from adjacent live parts of terminals; the partial insulation is coloured green/yellow.

Applications (IEC 60947-7-2)

This standard applies to PE terminals with PE function up to 120 mm² and to PE terminals with PEN function for sizes upwards of 10 mm² with clamping points with or without screws for connecting round copper conductors with a cross-section between 0.2 and 120 mm² (AWG 24/250 kcmil) for circuits up to 1000 Vac 1000 Hz or up to 1500 Vdc. PE terminals are used to produce the electrical and mechanical connections between copper conductors and the mounting.

Fuse terminals

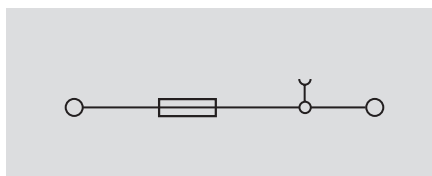

Fuse terminals consist of a terminal base and a cartridge fuse holder. In the case of fuse terminals for low-voltage cartridge fuses (D-system), the technical data are defined by IEC 60947-7-3 in conjunction with VDE 0636 part 301.

In the case of fuse terminals for device protection cartridge fuses, the technical data are defined by IEC 60947-7-3, which covers the range of applications of such products.

Fuse terminals for protecting devices are rated for a certain maximum power loss on the basis of IEC 60127-2, which covers G-type cartridge fuses.

The product pages contain details of the maximum power loss for individual or group arrangements for short-circuit and/or overload protection.

Multi-level distribution terminals

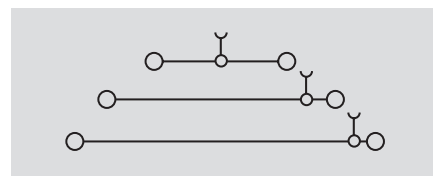

A multi-level distribution terminal is a unit with clamping points for connecting and/or linking phase, neutral and PE conductors to their mountings with a conductive PE connection. They have several connection levels, all isolated from each other.

Applications IEC 60947-7-1 / IEC 60947-7-2

DIN VDE 0611-4 (partly)

These standards apply to multi-level distribution terminals with clamping points with/without screws for connecting or linking solid, stranded or flexible copper conductors. In distribution terminals, phase conductor and/or N and PE conductor connections are all realised in a compact space.

The N-conductor can be disconnected for insulation measurements; it is not used for disconnecting or switching.

PEN function

According to IEC 60947-7-2, only copper terminal rails may be used for the PEN function. Steel terminal rails may not be used.

Use of TS 35 x 15

In order to comply with the current-carrying ability required by IEC 60947-7-2, the TS 35 x 15 terminal rail must be used for PE terminals with a rated cross-section of 16 mm² and upwards.

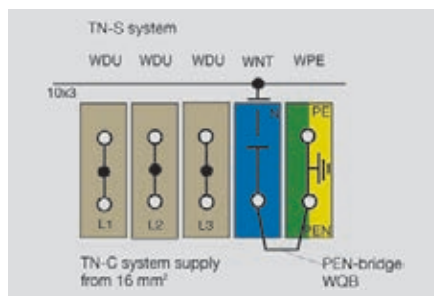

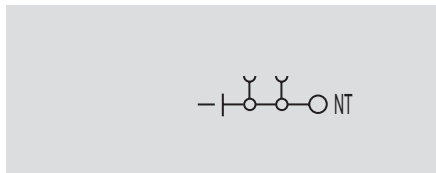
N-conductor disconnect terminals

A neutral-conductor disconnect terminal is a special type of test-disconnect terminal with lateral disconnection. It is connected to a neutral-conductor busbar. It will be covered in the scope of the IEC 60947-7-1 (2008 edition – Appendix D). The terminals are used for measuring the insulation resistance relative to the earth. They enable simple testing without the need to disconnect the neutral conductor.

Dimensioning of clearance and creepage distances:

400 V applies to
 phase conductor–phase conductor
 250 V applies to
 phase conductor–N-conductor
 phase conductor–PE conductor
 N-conductor–PE conductor

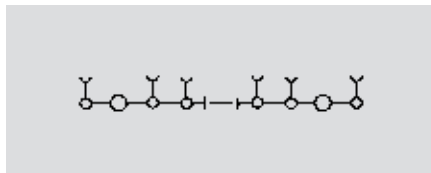
Test-disconnect terminals

Test-disconnect terminals are used for the short-term separation of circuits in order to perform test and measurements in a no-voltage state. They will be covered in the scope of the IEC 60947-7-1 (2008 edition – Appendix D). The dimensions for the clearance and creepage distances of the opened disconnect points are not evaluated. However the rated surge voltage resistance (supplied by the manufacturer) must be verified at the opened disconnect point.

ATEX terminals

Confirmed according to the new European Ex-Directive 94/9/EC – ATEX –

Basic specifications

IEC 60947-7-1 (EN 60 947-7-1/ VDE 0611P:1) and IEC 60 947-7-2 (EN 60 947-7-2/ VDE 0611P:3) are the basic specifications for terminals, and also protective conductor terminals. For use in potentially explosive atmospheres the following standards also apply: EN 50 014 (IEC 60 079-0/VDE 0170/0171 P.1) and for increased safety “e” EN 50 019 (IEC 60 079-7/ VDE 0170/0171 P. 6). Ex terminals are so-called Ex-components according to EN 50014.

Components means any item essential to the safe functioning of equipment and protective systems, but with no autonomous function.

Components according to the ATEX-directive 94/9/EC are not marked with CE.

Ex terminals are certified for the type of protection increased safety “e”.

According to the directive 94/9/EC, the European notified bodies have been issuing Ex-type examination certificates of the so-called ATEX-Generation in accordance with EN 50014 / 50019 and the Ex directive 94/9/EC.

KEMA, the authorized notified body and publisher of the Production Quality Assurance Notification, has confirmed with this publication that the manufacturer meets the requirements of the ATEX Directive according to the appendices IV and VII. Copies of the EC-type examination certificates, the notification documents and the declaration of conformity are available on the Internet. The clamping yoke, tension clamp, IDC, and Push-In terminal connection systems offer increased protection against accidental loosening. They are designed and shaped so that the end strands from flexible wires do not require any preparation.

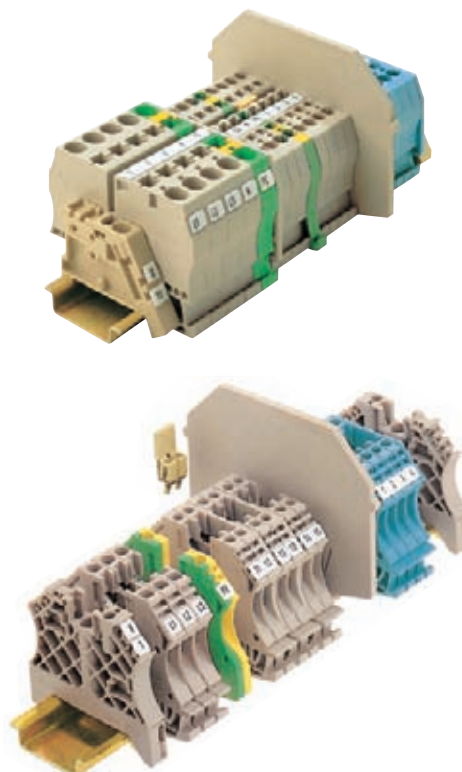

Marking

RL94/9EG: II 2 G-D

Ex electrical equipment

II 2-G Equipment group II category 2 (zone 1 electrical equipment)

II 2-D Equipment group II category 2 (zone 21 electrical equipment)

EN 60079-7: Ex e II

Ex Explosion protection

e Increased safety

II Equipment group

KEMA 97ATEX4677U (Example)

KEMA Notified body

ATEX Conformity with 94/9/EG

U Component

Confirmed according to the new European Ex-Directive 94/9/EC – ATEX –

Electrical data

The specified values of the current carrying capacity are related to an ambient temperature of 40 °C. At rated current load (+ 10%), the temperature of the currentbar of the terminal increases by a maximum of 40 K.

Recognizing an additional factor of safety according to EN 50 014, gives the following results:

Temperature class	Ambient temperature
T6	-50 °C to +40 °C
T5 to T1	-50 °C to +55 °C

If the real ambient temperature is higher, the permitted operating current must be reduced accordingly. As defined in EN 50 014, the continuous operating temperature for Wemid and KrG is 100 °C, for PA material 80 °C.

Accessories

The accessories listed in the tables can be used, and are listed in the Ex certifications. To maintain the creepage and clearance distances for “e”, end plates or partitions should be used, as specified in the table.

Design for Ex i

Terminals for “i” intrinsically-safe circuits are passive components. Therefore, there is no requirement for certification when being used in intrinsically safe circuits. The terminals are light blue to ensure clear identification and easy recognition. The construction type of these terminals must comply with EN 60079-11.

You may request additional information from Weidmüller concerning the use of our terminals in intrinsically-safe circuits.

Accessories

The listed accessory can be used. It must comply with EN 60079-11.

Mounting

The general statements also apply here for Ex i applications. Additionally, the Ex i requirements always apply to the complete circuit, therefore also for parts in nonpotentially explosive atmospheres.

Clampability of 2 conductors in Ex e

With our W series of terminals, it is normally permitted to connect two wires per terminal point. It is, however, necessary to use the next size down from the rated wire cross-section.

Current carrying capacity of cables and conductors

Cross-section	VDE 0298 Part 4 (IEC364-5-523) Current carrying capacity of conductors		EN 50019 2nd. edition Increased-safety type of protection connection terminals Ambient temperature 40 °C 40 K rise Current equivalent to connect conductor A
	Ambient temperature 30 °C Routing type C + 3 for PVC 70 °C conductors A	Ambient temperature 40 °C Factor 0.87 Routing type C + 3 for PVC 70 °C conduct A	
1.5	17.5	15.225	15
2.5	24	20.88	21
4	32	27.84	28
6	41	35.67	36
10	57	49.59	50
16	76	66.12	66
25	101	87.87	88
35	125	108.75	109
50	150	130.5	131
70	192	167.04	167
90	232	201.84	202
120	269	234.03	234
150	309	268.83	267
185	353	307.11	307
240	415	361.05	361
300	520	452.4	452

The current carrying capacity of cables and conductors in the installation is normally specified at 30 °C ambient temperature according to VDE 0298 Part 4.

At 40 °C, the operating current shall be reduced by a factor of 0.87.

ATEX directives

Since July 1, 2003, all new facilities in explosion risk zones must be certified according to ATEX Directive 94/9/EG or ATEX 95 (ATEX: ATmosphère EXplosive = explosive atmosphere). This directive is one of the „New Approach“ directives. It is valid in all European Union countries, as well as Iceland, Lichtenstein and Norway. In these countries, the directive refers to the sale and commissioning of products which have been designed particularly for high explosion risk environments (where explosive atmospheres exist due to gases, vapours, mists, or dusts). It now also covers the mining sector and purely mechanical devices.

Class of protection

Type of protection	Code	CENELEC EN	IEC	Product category explosion protect.
General requirements	–	60079-0	60079-0	–
Oil immersion	o	60079-6	60079-6	2
Pressurised apparatus	p	60079-2	60079-2	2
Powder filling	q	60079-5	60079-5	2
Flameproof enclosure	d	60079-1	60079-1	2
Increased safety	e	60079-7	60079-7	2
Intrinsic safety	ia	60079-11	60079-11	1
Intrinsic safety	ib	60079-11	60079-11	2
Intrinsic safety	ic	60079-11	60079-11	3
Type n (Ex n)	n	60079-15	60079-15	3
Encapsulation	m	60079-18	60079-18	2

Classification for potentially explosive areas

CENELEC classification IEC60079-10	Presence of potentially explosive atmosphere	Product category	US classification NEC 500	Combustible media
Zone 0	permanent, long-term	1G	Class I, Div 1	gases, vapours
Zone 20	or frequently	1D	Class II, Div 1	dust
Zone 1	occasionally	2G	Class I, Div 1	gases, vapours
Zone 20		2D	Class II, Div 1	dust
Zone 2	rarely and	3G	Class I, Div 2	gases, vapours
Zone 22	briefly	3D	Class II, Div 2	dust

Explosion groups

Gas (e.g.)	CENELEC	NEC 500
Propane	IIA	D
Ethylene	IIB	C
Hydrogen	IIC	B
Acetylene	IIC	A
Methane (mining)	I	mining (MSHA)

Temperature classes

Max. surface temperature (°C)	Temperature class CENELEC	Temperature class NEC 500-3
450	T1	T1
300	T2	T2
280	–	T2A
260	–	T2B
230	–	T2C
215	–	T2D
200	T3	T3
180	–	T3A
165	–	T3B
160	–	T3C
135	T4	T4
120	–	T4A
100	T5	T5
85	T6	T6

ATEX codes

Example of marking – modular terminal WDK 4 N V

- 1 • Rated voltage
- 2 • European symbol for explosion protection
- 3 • Certificate number
- 4 • Rated conductor cross-section
- 5 • CENELEC protection type “e” group II (gases, vapours, mists)
 - Product category 2 – for use in zone 1 or 2
 - Approved for use in gases “G” and dusts “D”

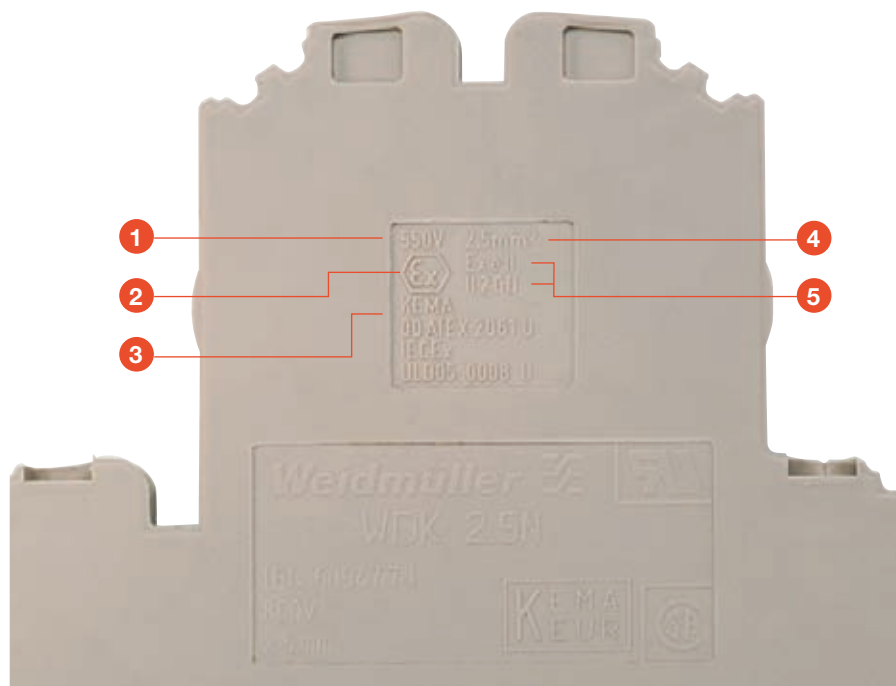

Example of marking – enclosure fitted with components for enhanced safety

- 1 • Type designation
- 2 • Serial number
- 3 • Approved for use in gases “G”
- 4 • Product category 2 – for use in zone 1 or 2
- 5 • Approved for use in dusts “D”
- 6 • CENELEC protection type “e” – increased safety
- 7 • Ambient temperature range deviating from the standard
- 8 • CENELEC protection type tD
- 9 • Temperature class, e.g. T6 (gas), and max. surface temperature (dust) (for example T6 T85 °C)
- 10 • Certificate number
- 11 • Rated voltage
- 12 • Rated current
- 13 • Power loss

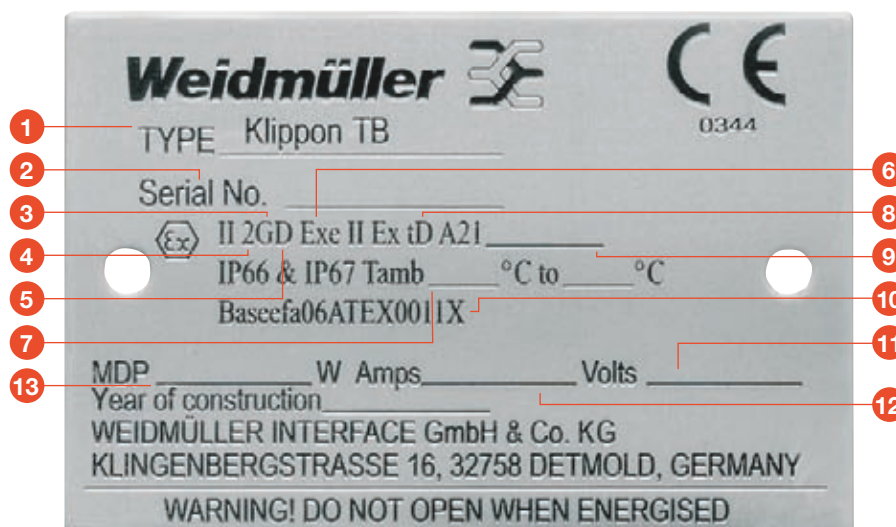

ATEX cross-connection instructions

Arrangements of terminals and cross-connections

The maximum voltages for Ex e applications given below are determined on the basis of the terminals used, their cross-connections and which of the arrangements (A to J) is used.

A Continuous

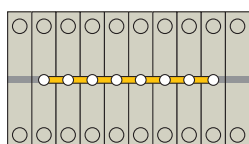

C Adjacent (used with QV) separated with a partition

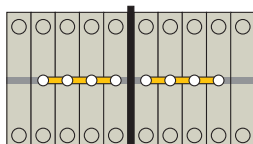

D Bypassing

bridging one or several unconnected terminals (e.g. every third)

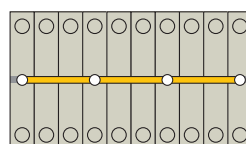

E Adjacent to a PE terminal (earth) Without partition

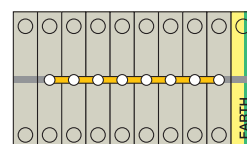

F Adjacent to a PE terminal (earth) with partition

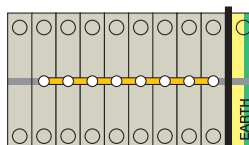

G Bypassing a PE terminal (earth) with QV cross-section

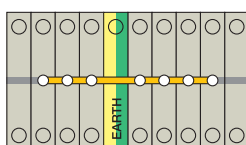

H 2 parallel cross-connections

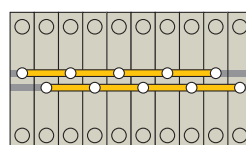

I 3 parallel cross-connections

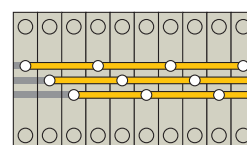

Maximum voltage

Range ¹⁾	Certificate No.	Rated voltage / V	Rated current / A	Rated current with QV cross-section / A	Nominal cross-section / mm ²
AKZ...		/ V	/ A	/ A	/ mm ²
AKZ 1.5	SIRA 02ATEX3001 U	176	15	15	1.5
AKZ 2.5	SIRA 02ATEX3001 U	176	21	21	2.5
AKZ 4	SIRA 02ATEX3001 U	275	28	28	4
BK...					
BK 2/E ... BK 12/E	SIRA 01ATEX3247 U	275	28	25	4
DK 4 ...					
DK 4	SIRA 02ATEX3316 U	275	28	21	4
DK 4Q	SIRA 02ATEX3316 U	275	28	21	4
DK 4QV	SIRA 02ATEX3316 U	275	28	21	4
I ... Series					
IDK 1.5N	KEMA 02ATEX2241 U	275	15	15	1.5
IDK 1.5N/V	KEMA 02ATEX2241 U	275	15	15	1.5
IDU 1.5N	KEMA 02ATEX2241 U	275	15	15	1.5
IDU 1.5N/2x2AN	KEMA 02ATEX2241 U	275	15	15	1.5
IDU 1.5N/ZF	KEMA 02ATEX2241 U	275	15	15	1.5
IDU 1.5N/3AN/ZF	KEMA 02ATEX2241 U	275	15	15	1.5
IDU 1.5N/ZB	KEMA 02ATEX2241 U	275	15	15	1.5
IDU 1.5N/3AN/ZB	KEMA 02ATEX2241 U	275	15	15	1.5
IDU 2.5N	DEMKO 03ATEX134054 U	550	21	21	2.5
IDU 2.5N/3AN	DEMKO 03ATEX134054 U	550	21	21	2.5
IDU 2.5N/4AN	DEMKO 03ATEX134054 U	550	21	21	2.5
IDU 2.5N/2x2AN	DEMKO 03ATEX134054 U	550	21	21	2.5
IDU 2.5N/ZF	DEMKO 03ATEX134054 U	550	21	21	2.5
IDU 2.5N/ZB	DEMKO 03ATEX134054 U	550	21	21	2.5
MK ...					
MK 3/.../E	SIRA 01ATEX3248U	275	21	21	2.5
MK 6/.../E	SIRA 01ATEX3249U	440	36	36	6

¹⁾ Please refer to the catalogue and the certificate for details of precisely which article is approved.

Maximum voltage (V)							
(letters refer to the above diagrams)							
A	C	D	E	F	G	H	I
176	176	--	176	176	--	--	--
176	176	--	176	176	--	--	--
275	275	--	275	275	--	--	--
176	--	--	--	--	--	--	--
275	275	--	275	275	--	--	--
275	275	--	275	275	--	--	--
275	275	--	275	275	--	--	--
275	275	275	--	--	--	--	--
275	275	275	--	--	--	--	--
275	275	275	275	275	275	275	--
275	275	275	275	275	275	275	--
275	275	275	275	275	275	275	--
275	275	275	275	275	275	275	--
550	550	550	550	550	550	--	--
550	550	550	550	550	550	--	--
550	550	550	550	550	550	--	--
550	550	550	550	550	550	--	--
550	550	275	550	550	275	--	--
550	550	275	550	550	275	--	--
176	--	--	--	--	--	--	--
275	--	--	--	--	--	--	--

Maximum voltage

Range ¹⁾	Certificate No.	Rated voltage	Rated current	Rated current with QV	Nominal cross-section
P ...		/ V	/ A	/ A	/ mm ²
PDU 2.5/4	KEMA 06ATEX0177U	550	29	25.5	4
PDU 2.5/4/3AN	KEMA 06ATEX0177U	550	29	25.5	4
PDU 2.5/4/4AN	KEMA 06ATEX0177U	550	29	26.5	4
PDU 6/10	KEMA 06ATEX0177U	550	37	26.5	6
PDU 6/10/3AN	KEMA 06ATEX0177U	550	36.5	29.5	6
PDU 16	KEMA 06ATEX0177U	550	59	57.5	16
PEI 16	KEMA 06ATEX0177U	550	66.5	25 (37) ⁴⁾	16
SAK ...TS 32/TS 35					
SAK 2.5	KEMA 97ATEX1798 U	550	21	21	2.5
SAK 4	KEMA 97ATEX1798 U	550	28	28	4
SAK 6N	KEMA 97ATEX1798 U	550	36	36	6
SAK 10	KEMA 97ATEX1798 U	550	50	50	10
SAK 16	KEMA 97ATEX1798 U	690	66	66	16
SAK 35	KEMA 97ATEX1798 U	550	109	99	35
SAK ... EN on TS32					
SAK 2.5 EN	KEMA 97ATEX1798 U	440	21	21	2.5
SAK 4 EN	KEMA 97ATEX1798 U	440	28	28	4
SAK 6N EN	KEMA 97ATEX1798 U	440	36	36	6
SAK 10 EN	KEMA 97ATEX1798 U	440	50	50	10
SAK 16 EN	KEMA 97ATEX1798 U	440	66	66	16
SAK 35 EN	KEMA 97ATEX1798 U	440	109	109	35
SAK ... EN on TS35					
SAK 2.5 EN	KEMA 97ATEX1798 U	690	21	21	2.5
SAK 4 EN	KEMA 97ATEX1798 U	690	28	28	4
SAK 6N EN	KEMA 97ATEX1798 U	690	36	36	6
SAK 10 EN	KEMA 97ATEX1798 U	690	50	50	10
SAK 16 EN	KEMA 97ATEX1798 U	690	66	66	16
SAK 35 EN	KEMA 97ATEX1798 U	690	109	109	35
SAK 4 EP/SAKH 6-35 EP					
SAK 4 EP/SW	KEMA05ATEX2061U	550	32	32	4
SAKH 6 EP/SW	KEMA05ATEX2061U	1100	57	57	10
SAKH 10 EP/SW	KEMA05ATEX2061U	1100	57	57	10
SAKH 35 EP/SW	KEMA05ATEX2061U	1100	125	125	35
SAKK ...					
SAKK 4	SIRA 03 ATEX3425 U	275	28	28	4
SAKK 10	SIRA 03 ATEX3425 U	275	50	50	10
W ...					
WDK 1.5/R3.5	KEMA 99ATEX6545 U	275	14	11	1.5
WDK 2.5	KEMA 98ATEX1687 U	275	21	21	2.5
WDK 2.5V	KEMA 98ATEX1687 U	275	21	21	2.5
WDK 2.5DU-PE	KEMA 98ATEX1687 U	275	21	21	2.5
WDK 2.5/EX	KEMA 98ATEX1687 U	440	24	22	2.5
WDK 2.5N	KEMA 00ATEX2061 U	550	21	21	2.5
WDK 2.5N V	KEMA 00ATEX2061 U	550	21	21	2.5
WDK 4N	KEMA 00ATEX2061 U	550	28	28	4
WDK 4N V	KEMA 00ATEX2061 U	550	28	28	4
WDU 1.5/ZZ	KEMA 98ATEX1685 U	550	15	15	1.5
WDU 2.5/1.5/ZR	KEMA 98ATEX1685 U	550	15	15	1.5
WDU 1.5/R3.5	KEMA 99ATEX6545 U	275	15	11	1.5
WDU 2.5N	KEMA 98ATEX1683 U	440	21	21	2.5
WDU 2.5	KEMA 98ATEX1683 U	550	21	21	2.5
WDU 4	KEMA 98ATEX1683 U	690	28	28	4
WDU 4N	TÜV 04ATEX2630 U	440	27	27	4
WDU 6	KEMA 98ATEX1683 U	550	36	36	6
WDU 10	KEMA 98ATEX1683 U	550	50	50	10
WDU 16	KEMA 98ATEX1683 U	690	66	66	16
WDU 35	KEMA 98ATEX1683 U	690	109	109	35
WDU 50N	KEMA 98ATEX1683 U	690	126	126	50
WDU 70N	KEMA 98ATEX1683 U	690	167	167	70
WDU 70/95	KEMA 98ATEX1686 U	690	202	202	95

¹⁾ Please refer to the catalogue and the certificate for details of precisely which article is approved.⁴⁾ For PDU2.5/4 and ZQV 2.5 cross-connection: 25 A; For PDU 6/10 and ZQV 6N cross-connection: 37 A

Maximum voltage (V)							
(letters refer to the above diagrams)							
A	C	D	E	F	G	H	I
275	550	176	275	275	176	176	
275	550	176	275	275	176	176	
275	550	176	275	275	176	176	
550	550	275	550	550	--	220	
550	550	275	550	550	--	220	
275	550	--	275	275	--	110	
275	--	--	--	--	--	--	
550	550	176	550	550	--	--	--
550	550	176	550	550	--	--	--
550	550	176	550	550	--	--	--
550	550	176	550	550	--	--	--
550	550	176	550	550	--	--	--
440	440	440	440	440	--	--	--
440	440	440	440	440	--	--	--
440	440	440	440	440	--	--	--
440	440	440	440	440	--	--	--
440	440	440	440	440	--	--	--
440	440	440	440	440	--	--	--
690	690	440	690	690	--	--	--
690	690	690	690	690	--	--	--
690	690	690	690	690	--	--	--
690	690	690	690	690	--	--	--
690	690	690	690	690	--	--	--
690	690	690	690	690	--	--	--
550	550	176	550	550	--	--	--
1100	1100	176	1100	1100	--	--	--
1100	1100	176	1100	1100	--	--	--
1100	1100	440	1100	1100	--	--	--
275	275	--	275	275	--	--	--
275	275	--	275	275	--	--	--
176	275	--	--	--	--	--	--
275	275	60	275	275	60	--	--
275	275	60	275	275	60	--	--
275	275	60	275	275	60	--	--
440	440	176	440	440	176	--	--
550	550	275	550	550	275	--	--
550	550	275	550	550	275	--	--
550	550	275	550	550	275	--	--
550	550	110	550	550	110	110	--
550	550	110	550	550	110	110	--
176	275	--	--	--	--	--	--
440	440	110	440	440	110	--	--
550	550	110	440	550	110	110 ²⁾	60 ³⁾
690	690	110	440	690	110	--	--
440	275	69	440	440	69	69	--
550	550	110	440	550	110	--	--
550	550	110	440	550	110	--	--
690	690	110	690	690	110	--	--
690	690	110	690	690	110	--	--
550	--	--	550	550	--	--	--
550	--	--	550	550	--	--	--
690	--	--	690	690	--	--	--

²⁾ The outer cross-connection openings must be used for type ZQV.³⁾ Only possible with ZQV.

Maximum voltage

Range ¹⁾	Certificate No.	Rated voltage	Rated current	Rated current with QV	Nominal cross-section
W ...		/ V	/ A	/ A	/ mm ²
WDU 95N/120N	KEMA 98ATEX1683 U	880	243	243	120
WDU 120/150	KEMA 98ATEX1686 U	1100	234	234	120
WDU 240	KEMA 01ATEX2186 U	1100	350	270	240
WDU 4 SL	SIRA 02ATEX3242 U	275	28	28	4
WDU 6 SL	SIRA 02ATEX3242 U	275	36	36	6
WDU 10 SL	SIRA 02ATEX3242 U	275	50	50	10
Z ...					
ZDK 2.5/1.5	KEMA 97ATEX4677 U	275	18	18	2.5
ZDK 2.5/1.5V	KEMA 97ATEX4677 U	420	20	19	2.5
ZDK 2.5/1.5NDU	KEMA 97ATEX4677 U	275	20	20	2.5
ZDK 2.5/1.5NPE	KEMA 97ATEX4677 U	275	20	20	2.5
ZDK 2.5/1.5DU-PE	KEMA 97ATEX4677 U	275	20	20	2.5
ZDK 2.5-2	KEMA 97ATEX4677 U	550	20	18	2.5
ZDK 2.5-2V	KEMA 97ATEX4677 U	550	22	18	2.5
ZDK 2.5-2DU-PE	KEMA 97ATEX4677 U	550	20	18	2.5
ZDK 2.5/3AN	KEMA 06ATEX0271U	550	21.5	21	2.5
ZDK 2.5/3AN V	KEMA 06ATEX0271U	550	21	18.5	2.5
ZDK 2.5/3AN DU-PE	KEMA 06ATEX0271U	550	21	21	2.5
ZDU 1.5	KEMA 01ATEX2106 U	550	15	15	1.5
ZDU 1.5/3AN	KEMA 01ATEX2106 U	550	15	15	1.5
ZDU 1.5/4AN	KEMA 01ATEX2106 U	550	15	15	1.5
ZDU 2.5	KEMA 97ATEX2521 U	550	21	21	2.5
ZDU 2.5/3AN	KEMA 97ATEX2521 U	550	21	21	2.5
ZDU 2.5/4AN	KEMA 97ATEX2521 U	550	21	21	2.5
ZDU 2.5N	KEMA 06ATEX0271U	550	20.5	19	2.5
ZDU 2.5N/3AN	KEMA 06ATEX0271U	550	21.5	21	2.5
ZDU 2.5N/4AN	KEMA 06ATEX0271U	550	21	20	2.5
ZDU 4	KEMA 97ATEX2521 U	550	28	28	4
ZDU 4/3AN	KEMA 00ATEX2107 U	550	28	28	4
ZDU 4/4AN	KEMA 00ATEX2107 U	550	28	28	4
ZDU 6	KEMA 97ATEX2521 U	550	36	36	6
ZDU 6/3AN	KEMA 00ATEX2107 U	550	36	36	6
ZDU 10	KEMA 99ATEX5514 U	550	50	50	10
ZDU 10/3AN	KEMA 00ATEX2107 U	550	50	50	10
ZDU 16	KEMA 99ATEX5514 U	550	66	66	16
ZDU 35	KEMA 00ATEX2107 U	690	109	100	35
ZDU 2.5-2/2AN	KEMA 97ATEX4677 U	550	21	20	2.5
ZDU 2.5-2/3AN	KEMA 97ATEX4677 U	550	21	21	2.5
ZDU 2.5-2/4AN	KEMA 97ATEX4677 U	550	21	21	2.5
ZDU 4-2/2AN	KEMA 97ATEX4677 U	550	28	26	4
ZDU 4-2/3AN	KEMA 97ATEX4677 U	550	28	26	4
ZDU 4-2/4AN	KEMA 97ATEX4677 U	550	28	26	4
ZDU 6-2/2AN	KEMA 97ATEX4677 U	550	36	30	6
ZDU 6-2/3AN	KEMA 97ATEX4677 U	550	36	36	6
ZDUA 2.5-2	KEMA 97ATEX4678 U	275	20	19	2.5

¹⁾ Please refer to the catalogue and the certificate for details of precisely which article is approved.

Maximum voltage (V)							
(letters refer to the above diagrams)							
A	C	D	E	F	G	H	I
880	--		880	880	--	--	--
1100	--	--	1100	1100	--	--	--
--	--	--	--	--	--	--	--
275	275	176	275	275	176	176	--
275	275	176	275	275	176	176	--
275	275	176	275	275	176	176	--
275	275	176	275	275	176	176	--
275	275	275	275	275	275	--	--
275	275	275	275	275	275	--	--
275	275	275	275	275	275	--	--
275	275	275	275	275	275	--	--
440	440	275	440	440	275	--	--
440	440	275	440	440	275	--	--
440	440	275	440	440	275	--	--
275	275	275	275	275	--	--	--
275	275	275	275	275	--	--	--
275	275	176	275	275	176	176	--
275	275	176	275	275	176	176	--
275	275	176	275	275	176	176	--
275	275	275	275	275	275	60	--
275	275	275	275	275	275	--	--
275	275	275	275	275	275	--	--
440	550	275	440	440	--	--	--
440	550	275	440	440	--	--	--
440	550	275	440	440	--	--	--
275	275	275	275	275	275	--	--
550	550	275	--	--	--	--	--
550	550	275	--	--	--	--	--
275	275	275	275	275	275	--	--
550	550	275	--	--	--	--	--
550	--	--	--	--	--	--	--
550	550	--	--	--	--	--	--
550	--	--	--	--	--	--	--
550	550	--	550	550	--	--	--
440	440	275	440	--	275	176	--
440	440	275	440	--	275	176	--
440	440	275	440	--	275	176	--
440	440	275	440	--	275	110	--
440	440	275	440	--	275	110	--
440	440	110	440	--	110	--	--
440	440	110	440	--	110	--	--
275	275	110	275	275	110	--	--

Index

Index	Index Type / Index Order No.	X.2
	Addresses worldwide	X.28

Type	Order No.	Page	Type	Order No.	Page	Type	Order No.	Page	Type	Order No.	Page
A			AH 46 SAKG46	0326960000	1.17	AP DK4	0359260000	A.54	AP SAK2.5/35 + AST3+4	0460560000	1.6
			AH 46 SAKG46	0326960000	A.46	AP DK4	0359260000	B.10	AP SAK2.5/35 BL	0460580000	1.6
AD 250	0634100000	1.18	AH 46 SAKG46	0326960000	A.47	AP DK4	0359260000	A.50	AP SAK2.5/35 DB	0460490000	1.6
AD 3 SAK10	0178500000	1.17	AK 95	0364200000	H.5	AP DK4	0359260000	B.56	AP SAK2.5L KR	0309220000	1.4
AD 3 SAK16	0297800000	B.4	AKA 2.5	0300720000	E.12	AP DK4	0359260000	1.6	AP SAK2.5L KR	0309220000	B.45
AD 3 SAK16	0297800000	1.17	AKA 2.5 BL	0300770000	E.12	AP DK4 BL	0359280000	A.12	AP SAK2.5L KR	0309220000	1.6
AD 3 SAK2.5	0297900000	B.2	AKE 2.5	1303360000	E.4	AP DK4 BL	0359280000	B.38	AP SAK2.5L KR BL	0309270000	1.6
AD 3 SAK2.5	0297900000	A.12	AKE 4	0380260000	E.5	AP DK4 BL	0359280000	1.6	AP SAK2.5L KR BL	0309270000	B.45
AD 3 SAK2.5	0297900000	C.2	AKE 4 MS	0211200000	E.4	AP DK4 BL	0359280000	B.10	AP SAK35 KR	0303620000	1.6
AD 3 SAK2.5	0297900000	1.17	AKKU DMS 3	9007450000	J.10	AP DK4/380 Q	0438560000	1.4	AP SAK35 KR	0303620000	1.4
AD 3 SAK2.5	0297900000	A.2	AKZ 1.5	0340460000	E.2	AP DK4/380 Q	0438560000	1.6	AP SAK35 KR	0303620000	B.8
AD 3 SAK35	0273400000	B.4	AKZ 1.5 BL	0340480000	E.2	AP DK4Q	1397160000	B.11	AP SAK35 KR	0303620000	B.9
AD 3 SAK35	0273400000	1.17	AKZ 1.5L VS	0340160000	E.10	AP DK4Q	1397160000	A.12	AP SAK35 KR	0303620000	A.9
AD 3 SAK4	0297600000	1.17	AKZ 2.5	0697160000	E.2	AP DK4Q	1397160000	A.13	AP SAK35 KR/BL	0303670000	B.8
AD 3 SAK6N	0297770000	1.17	AKZ 2.5 BL	0697180000	E.2	AP DK4Q	1397160000	B.10	AP SAK35 KR/BL	0303670000	B.9
AD 3 SAK70	0344300000	B.9	AKZ 2.5 K SW U/V 1X1	0108960000	E.13	AP DK4Q	1397160000	B.34	AP SAK35 KR/BL	0303670000	A.9
AD 3 SAK70	0344300000	A.6	AKZ 4	0294360000	E.3	AP DK4Q	1397160000	1.6	AP SAK35 KR/BL	0303670000	1.6
AD 3 SAK70	0344300000	1.17	AKZ 4 BL	0294380000	E.3	AP DK4Q	1397160000	A.34	AP SAK35/TW SAK16	0303660000	B.5
AD 3 WSD SAKG54 HP/DBR	0264900000	1.17	AKZ 4 LL VS	0346460000	E.11	AP DK4Q BL	1397180000	1.6	AP SAK35/TW SAK16	0303660000	1.6
AD 4 AKZ4	0303400000	E.10	AKZ 4 S WA 2X2.8	0324460000	E.9	AP DK4Q BL	1397180000	A.12	AP SAK35/TW SAK16	0303660000	C.4
AD 4 AKZ4	0303400000	B.39	AKZ 4 SF SE 6.3/2.8	0158760000	E.9	AP DK4Q BL	1397180000	B.10	AP SAK35/TW SAK16	0303660000	1.4
AD 4 AKZ4	0303400000	E.12	AKZ 4 SS SE 6.3/2.8	0324560000	E.8	AP DK4Q BL	1397180000	B.11	AP SAK35/TW SAK16	0303660000	A.4
AD 4 AKZ4	0303400000	E.11	AKZ 4 SS WA 2X2.8	0324600000	E.8	AP DK4Q BL	1397180000	A.13	AP SAK35/TW SAK16	0303660000	A.5
AD 4 AKZ4	0303400000	B.45	AKZ 4 SW 1X1	0445860000	E.13	AP DK4S	0631360000	1.6	AP SAK35/TW SAK16	0303660000	B.4
AD 4 AKZ4	0303400000	B.11	AKZ 4L SL VS	0334860000	E.10	AP DK4S	0631360000	A.38	AP SAK35/TW SAK16 BL	0303680000	B.7
AD 4 AKZ4	0303400000	A.7	AKZ 4L SL VS KR	0334820000	E.12	AP DK4S	0631360000	B.37	AP SAK35/TW SAK16 BL	0303680000	C.4
AD 4 AKZ4	0303400000	A.40	AP DK4Q DB	0631300000	1.6	AP DK4S	0631360000	A.39	AP SAK35/TW SAK16 BL	0303680000	1.6
AD 4 AKZ4	0303400000	1.17	AP 100 GR	1773410000	1.6	AP DK4S BL	0631380000	1.6	AP SAK35/TW SAK16 BL	0303680000	B.5
AD 4 AKZ4	0303400000	A.13	AP 110 GR	1790080000	1.6	AP DK4T	0635060000	1.6	AP SAK35/TW SAK16 BL	0303680000	A.5
AD 4 AKZ4	0303400000	B.6	AP 2 DSG1.5T	2119490000	1.6	AP DK4T PA	0687560000	B.17	AP SAK35/TW SAK16 BL	0303680000	A.4
AD 4 SAK10	0178600000	C.3	AP 70 SAK70 KR	0340920000	1.6	AP DK4T PA	0687560000	B.61	AP SAK35/TW SAK16 BL	0303680000	B.4
AD 4 SAK10	0178600000	1.17	AP 70 SAK70 KR	0340920000	B.9	AP DK4T PA	0687560000	1.6	AP SAK35/TW SAK16 GE	2076910000	1.6
AD 4 SAK10	0178600000	B.7	AP 70 SAK70 KR	0340920000	1.4	AP DK4T PA	0687560000	A.19	AP SAK4 KR	0460020000	1.6
AD 4 SAK10	0178600000	A.8	AP ADK1	0476260000	1.6	AP DK4T PA	0687560000	A.56	AP SAK4-10	0117960000	A.38
AD 4 SAK10	0178600000	A.3	AP ADK1	0476260000	E.11	AP DLD2.5	1317660000	1.6	AP SAK4-10	0117960000	A.37
AD 4 SAK10	0178600000	B.3	AP AKA2.5	0162520000	1.6	AP DLD2.5 BL	1317680000	1.6	AP SAK4-10	0117960000	A.3
AD 4 SAK16	0518200000	B.7	AP AKA2.5	0162520000	E.12	AP DLD2.5 DB	1784210000	1.6	AP SAK4-10	0117960000	B.3
AD 4 SAK16	0518200000	1.17	AP AKA2.5 KR/BL	0162570000	E.12	AP DLD2.5/PE	1595960000	1.6	AP SAK4-10	0117960000	B.37
AD 4 SAK16	0518200000	C.3	AP AKA2.5 KR/BL	0162570000	1.6	AP DLD2.5/PE DB	1783800000	1.6	AP SAK4-10	0117960000	B.44
AD 4 SAK16	0518200000	A.4	AP AKZ1.5	0340560000	E.2	AP DLD2.5	1313260000	1.6	AP SAK4-10	0117960000	C.2
AD 4 SAK16	0518200000	A.9	AP AKZ1.5	0340560000	1.4	AP DLD2.5 DB	1783550000	1.6	AP SAK4-10	0117960000	C.3
AD 4 SAK35	0178700000	C.4	AP AKZ1.5	0340560000	1.6	AP DSK1.5	0532960000	1.6	AP SAK4-10	0117960000	C.4
AD 4 SAK35	0178700000	1.17	AP AKZ1.5 BL	0340580000	E.2	AP DUSA4/35	0401360000	1.6	AP SAK4-10	0117960000	C.5
AD 4 SAK35	0178700000	A.9	AP AKZ1.5 BL	0340580000	E.6	AP KDKS1 1.5	9503330000	1.6	AP SAK4-10	0117960000	1.6
AD 4 SAK35	0178700000	B.5	AP AKZ1.5W	0329660000	E.10	AP KDKS1 1.5 DB	9532470000	1.6	AP SAK4-10 BL	0117980000	C.3
AD 4 SAK35	0178700000	A.5	AP AKZ1.5W	0329660000	1.6	AP KDKS1 EN	9503340000	1.6	AP SAK4-10 BL	0117980000	C.5
AD 4 SAK35	0178700000	A.4	AP AKZ1.5W	0329660000	1.4	AP KDKS1 EN	9503340000	C.7	AP SAK4-10 BL	0117980000	C.4
AD 4 SAK35	0178700000	B.8	AP AKZ2.5	0697360000	1.6	AP KSKM	9509630000	1.6	AP SAK4-10 BL	0117980000	C.2
AD 4 SAK35N	0576700000	A.9	AP AKZ2.5	0697360000	E.2	AP MAK2.5	1615280000	1.6	AP SAK4-10 BL	0117980000	B.3
AD 4 SAK35N	0576700000	B.5	AP AKZ2.5 BL	0697380000	1.6	AP MAK2.5 DB	7917000000	1.6	AP SAK4-10 BL	0117980000	1.6
AD 4 SAK35N	0576700000	1.17	AP AKZ2.5 BL	0697380000	E.2	AP OSC 10/16	9154850000	1.6	AP SAK4-10 BL	0117980000	A.3
AD 4 SAK35N	0576700000	A.5	AP AKZ2.5K	0697260000	E.13	AP OSC 4	9154860000	1.6	AP SAK4-10 DB	0105100000	1.6
AD 4 SAK35N	0576700000	B.9	AP AKZ2.5K	0697260000	1.6	AP PPT/35	3835120000	1.6	AP SAK4-10 GE	2076890000	1.6
AD 4 SAK4	0285300000	C.4	AP AKZ4	0294460000	1.6	AP PPT/35	3835120000	D.9	AP SAK4-10 GR 7042	1853970000	1.6
AD 4 SAK4	0285300000	A.3	AP AKZ4	0294460000	E.8	AP RSF1 KR	0270420000	1.6	AP SAK4-10 I	0117910000	1.6
AD 4 SAK4	0285300000	B.3	AP AKZ4	0294460000	E.9	AP RSF2 KR	0301420000	1.6	AP SAK4-10 KR	0117920000	A.4
AD 4 SAK4	0285300000	B.6	AP AKZ4	0294460000	1.4	AP RSF3	0270460000	1.6	AP SAK4-10 KR	0117920000	1.6
AD 4 SAK4	0285300000	C.5	AP AKZ4	0294460000	E.11	AP RSF3	0270460000	A.11	AP SAK4-10 KR	0117920000	A.7
AD 4 SAK4	0285300000	1.17	AP AKZ4	0294460000	E.13	AP RSF3	0270460000	B.28	AP SAK4-10 KR	0117920000	A.20
AD 4 SAK4	0285300000	A.7	AP AKZ4	0294460000	E.12	AP RV	4145220000	1.6	AP SAK4-10 KR	0117920000	B.44
AD 4 SAK4	0285300000	C.2	AP AKZ4	0294460000	E.10	AP SAK16	0271160000	1.4	AP SAK4-10 KR	0117920000	B.7
AD 4 SAK6N	0196600000	A.8	AP AKZ4	0294460000	E.3	AP SAK16	0271160000	1.6	AP SAK4-10 KR	0117920000	B.19
AD 4 SAK6N	0196600000	B.3	AP AKZ4 BL	0294480000	1.6	AP SAK16	0271160000	B.4	AP SAK4-10 KR	0117920000	B.6
AD 4 SAK6N	0196600000	C.3	AP AKZ4 BL	0294480000	E.3	AP SAK16	0271160000	A.4	AP SAK4-10 KR	0117920000	A.8
AD 4 SAK6N	0196600000	1.17	AP AKZ4 GE	2077070000	1.6	AP SAK16	0271160000	C.3	AP SAK4-10 KR/BL	0117970000	B.19
AD 4 SAK6N	0196600000	A.3	AP AKZ4 KR	0294420000	1.6	AP SAK16 BL	0271180000	C.3	AP SAK4-10 KR/BL	0117970000	A.8
AD 4 SAK6N	0196600000	B.7	AP AKZ4 KR	0294420000	1.4	AP SAK16 BL	0271180000	1.6	AP SAK4-10 KR/BL	0117970000	A.7
AD 4 WSD SAKG28 HP/DBR	0263100000	1.17	AP ASK1	0380360000	C.7	AP SAK16 BL	0271180000	A.4	AP SAK4-10 KR/BL	0117970000	B.44
AD 4 WSD SAKG32 HP/DBR	0283100000	1.17	AP ASK1 BL	0380360000	1.6	AP SAK16 BL	0271180000	B.4	AP SAK4-10 KR/BL	0117970000	B.7
AD 4 WSD SAKG40 HP/DBR	0263200000	1.17	AP ASK1 DB	1753320000	1.6	AP SAK16 GE	2076900000	1.6	AP SAK4-10 KR/BL	0117970000	1.6
AD 4 WSD SAKG46 HP/DBR	0263300000	1.17	AP ASK1 OR	0105360000	1.6	AP SAK16 KR	0271120000	1.6	AP SAK4-10 KR/BL	0117970000	B.6
AD 4 WSD SAKG54 HP/DBR	0261100000	1.17	AP ASK1 RT	0380350000	1.6	AP SAK16 KR	0271120000	B.7	AP SAK4-10 KR/BL	0117970000	A.20
ADAPTER ALU STI-S	1762440000	K.25	AP AST1+5	0266460000	1.6	AP SAK16 KR	0271120000	A.9	AP SAK4-10 KR/DB	0177600000	1.6
ADAPTER ALU STI-S	0303860000	E.11	AP AST1+5 DB	0266400000	B.36	AP SAK2.5	0279560000	1.4	AP SAK4-10 OR	0105160000	1.6
ADL	0210800000	1.18	AP AST1+5 DB	0266400000	A.37	AP SAK2.5	0279560000	A.2	AP SAK4-10 RT	0117900000	1.6
ADP 1/HP1 1M	0485200000	1.16	AP AST1+5 DB	0266400000	A.36	AP SAK2.5	0279560000	B.38	AP SAK70/35	0340960000	A.6
ADP 2/HP2 1M	0485300000	1.16	AP AST1+5 DB	0266400000	1.6	AP SAK2.5	0279560000	B.39	AP SAK70/35	0340960000	1.6
ADP 2/HP2 1M	0485300000	A.11	AP AST1+5 KR	0266420000	1.6	AP SAK2.5	0279560000				

Type	Order No.	Page	Type	Order No.	Page	Type	Order No.	Page	Type	Order No.	Page
AP SAKD2.5N	0150960000	1.6	BFSC M2.5X14 SAKD2.5N	0266800000	B.60	BK 2/E	7906040000	F.6	DEK 5 FS 701-750	0473560701	K.7
AP SAKD2.5N	0150960000	1.4	BFSC M2.5X14 SAKD2.5N	0266800000	A.54	BK 3 CRN	0624920000	F.5	DEK 5 FS 751-800	0473560751	K.7
AP SAKD2.5N	0150960000	B.2	BFSC M2.5X18 PA/RT	0303300000	E.11	BK 3/E	7906060000	F.6	DEK 5 FS 801-850	0473560801	K.7
AP SAKD2.5N BL	0150980000	1.6	BFSC M2.5X18 PA/RT	0303300000	B.11	BK 4 CRN	0625120000	F.5	DEK 5 FS 851-900	0473560851	K.7
AP SAKD2.5N BL	0150980000	A.2	BFSC M2.5X18 PA/RT	0303300000	1.17	BK 4/E	7906080000	F.6	DEK 5 FS 901-950	0473560901	K.7
AP SAKD2.5N BL	0150980000	B.2	BFSC M2.5X18 PA/RT	0303300000	A.12	BK 6 CRN	0625220000	F.5	DEK 5 FS 951-999	0473560951	K.7
AP SAKH 4EX	0408730000	1.6	BFSC M2.5X18 PA/RT	0303300000	E.12	BK 6/E	7906090000	F.6	DEK 5 FSZ 1-10	0460660001	K.7
AP SAKH6/10 EP/SW	0131700000	D.7	BFSC M2.5X18 PA/RT	0303300000	A.13	BS 25 IH/BL SAKT1	0335400000	I.21	DEK 5 FSZ 11-20	0460660011	K.7
AP SAKH6/10 EP/SW	0131700000	1.6	BFSC M2.5X18 PA/RT	0303300000	E.10	BS 25 IH/GE SAKT1	0335700000	I.21	DEK 5 FSZ 18,20,...32	0582360018	K.7
AP SAKH6/10 EP/SW	0131700000	D.6	BFSC M3X22 PA/RT	0128900000	A.7	BS 25 IH/GN SAKT1	0335600000	I.21	DEK 5 FSZ 2,4,6...16	0582360002	K.7
AP SAKH6/10 KRG	0131720000	1.6	BFSC M3X22 PA/RT	0128900000	1.17	BS 25 IH/GR SAKT1	0335300000	I.21	DEK 5 FSZ 21-30	0460660021	K.7
AP SAKH6/10 KRS	0131730000	1.4	BFSC M3X22 PA/RT	0128900000	A.8	BS 25 IH/RT SAKT1	0335500000	I.21	DEK 5 FSZ 31-40	0460660031	K.7
AP SAKK4/10 KER/WS	9502630000	1.6	BFSC M3X22 PA/RT	0128900000	C.5	BS 25 IH/SW SAKT1	0335200000	I.21	DEK 5 FSZ 41-50	0460660041	K.7
AP SAKK4/10 KER/WS	9502630000	D.3	BFSC M3X22 PA/RT	0128900000	A.9	BS 25 IH/M SAKT1	0335800000	I.21	DEK 5 FSZ 51-60	0460660051	K.7
AP SAKK4/10 KER/WS	9502630000	D.2	BFSC M3X22 PA/RT	0128900000	A.3	BS 25 O.IH SAKT1	0334700000	B.32	DEK 5 FSZ 61-70	0460660061	K.7
AP SAKR BE	0211360000	A.18	BFSC M3X22 PA/RT	0128900000	B.2	BS 25 O.IH SAKT1	0334700000	A.32	DEK 5 FSZ 71-80	0460660071	K.7
AP SAKR BE	0211360000	B.16	BFSC M3X22 PA/RT	0128900000	A.40	BS 25 O.IH SAKT1	0334700000	I.21	DEK 5 FSZ 81-90	0460660081	K.7
AP SAKR BE	0211360000	1.4	BFSC M3X22 PA/RT	0128900000	C.4	BS 25 O.IH SAKT1	0334700000	B.31	DEK 5 FSZ 91-100	0460660091	K.7
AP SAKR BE	0211360000	1.6	BFSC M3X22 PA/RT	0128900000	B.45	BS 25 O.IH SAKT1	0334700000	A.33	DEK 5 FW 1.3,5,...99	1358460000	K.7
AP SAKR BE	0211360000	B.39	BFSC M3X22 PA/RT	0128900000	B.39	BS 35/WSH 2	1760720000	G.7	DEK 5 FW 101-150	0473460101	K.7
AP SAKR BE	0211360000	E.3	BFSC M3X22 PA/RT	0128900000	A.4	BS 35H KLBUE HOLDER	1723800000	G.10	DEK 5 FW 10-500	0132660010	K.7
AP SAKR BE	0211360000	B.41	BFSC M3X22 PA/RT	0128900000	B.4	BS 35H KLBUE2X3-B/2X2-6	1768020000	G.10	DEK 5 FW 1-50	0473460001	K.7
AP SAKR BE	0211360000	B.40	BFSC M3X22 PA/RT	0128900000	B.3	BS 35H KLBUE3-8	1723810000	G.10	DEK 5 FW 151-200	0473460151	K.7
AP SAKR BE	1820200000	1.6	BFSC M3X22 PA/RT	0128900000	C.3	BS 35H KLBUE3-B/2X2-6	1749430000	G.10	DEK 5 FW 2,4,...100	1358560000	K.7
AP SAKR BL	0211380000	1.6	BFSC M3X22 PA/RT	0128900000	A.2	BS 35H/KLBUE 4-13.5	1723820000	G.10	DEK 5 FW 201-250	0473460201	K.7
AP SAKR BL	0211380000	B.40	BFSC M3X22 PA/RT	0128900000	C.2	BST 2 BEZEICHNUNGSSTR.	1287700000	I.17	DEK 5 FW 251-300	0473460251	K.7
AP SAKR BL	0211380000	B.41	BFSC M3X22 PA/RT	0128900000	B.7	BSTB 28/12 BK U 1-12	0198800000	F.5	DEK 5 FW 301-350	0473460301	K.7
AP SAKR BL	0211380000	B.16	BFSC M3X22 PA/RT	0128900000	B.6	BSTB 28/12 BK U 1-12	0198800000	F.6	DEK 5 FW 351-400	0473460351	K.7
AP SAKR BL	0211380000	A.18	BFSC M3X22 SAKT4	1319900000	A.33	BSTB 28/12 MK U 1-12	0245900000	F.6	DEK 5 FW 401-450	0473460401	K.7
AP SAKR KRG	0211320000	B.18	BFSC M3X22 SAKT4	1319900000	B.32	BSTB 28/12 MK U 1-12	0245900000	F.2	DEK 5 FW 451-500	0473460451	K.7
AP SAKR KRG	0211320000	1.6	BFSC M3X25	0292500000	A.3	BSTB 28/12/6,35 O 1-12	0278500000	F.2	DEK 5 FW 501-550	0473460501	K.7
AP SAKS1+3 KRG	0191320000	B.22	BFSC M3X25	0292500000	C.2	BSTB 28/12/6,35 U 1-12	0245700000	F.2	DEK 5 FW 51-100	0473460051	K.7
AP SAKS1+3 KRG	0191320000	1.4	BFSC M3X25	0292500000	C.3	BSTB 28/16 MK O 1-16	0278700000	F.3	DEK 5 FW 551-600	0473460551	K.7
AP SAKS1+3 KRG	0191320000	A.24	BFSC M3X25	0292500000	A.7	BSTB 28/16 MK U 1-16	0262200000	F.3	DEK 5 FW 601-650	0473460601	K.7
AP SAKS1+3 KRG	0191320000	B.23	BFSC M3X25	0292500000	1.12	BSTB 28/2 BK U 1-2	0203600000	F.5	DEK 5 FW 651-700	0473460651	K.7
AP SAKS1+3 KRG	0191320000	A.25	BFSC M3X25	0292500000	C.4	BSTB 28/2 BK U 1-2	0203600000	F.6	DEK 5 FW 701-750	0473460701	K.7
AP SAKS1+3 KRG	0191320000	1.6	BFSC M3X25	0292500000	A.8	BSTB 28/4 BK U 1-4	0197300000	F.6	DEK 5 FW 751-800	0473460751	K.7
AP SAKS1+3 KRG/DB	0191300000	1.6	BFSC M3X25	0292500000	A.9	BSTB 28/4 BK U 1-4	0197300000	F.5	DEK 5 FW 801-850	0473460801	K.7
AP SAKT2 KRG	0329120000	1.6	BFSC M3X25	0292500000	1.10	BSTB 28/6 BK U 1-6	0197500000	F.6	DEK 5 FW 851-900	0473460851	K.7
AP SAKT2 KRG	0329120000	1.4	BFSC M3X25	0292500000	C.5	BSTB 28/6 BK U 1-6	0197500000	F.5	DEK 5 FW 901-950	0473460901	K.7
AP SAKT4 KRG	0244920000	1.6	BFSC M3X25	0292500000	B.7	BSTB 28/6 MK U 1-6	0290000000	F.6	DEK 5 FW 951-999	0473460951	K.7
AP ST5 PA/BE	0447260000	1.6	BFSC M3X25	0292500000	A.4	BSTB 28/6 MK U 1-6	0290000000	F.2	DEK 5 FW U1-PE1	0133161114	K.7
AP ST5 PPO/SW	0447240000	1.6	BFSC M3X25	0292500000	B.6	BSTB 28/8 MK U 1-8	0290200000	F.2	DEK 5 FW U2-PE2	0133161115	K.7
AP ST5 PPO/SW	0447240000	C.6	BFSC M3X25	0292500000	B.3	BSTB 28/8 MK U 1-8	0290200000	F.6	DEK 5 FW U3-PE3	0133161116	K.7
AP STA2.5 0.5MM	2012770000	1.6	BFSC M3X25	0292500000	B.4	BSTO 28/12 BK	0198700000	F.5	DEK 5 FW U4-PE4	0133161117	K.7
AP TAL	0212260000	1.6	BFSC M3X30	0296200000	B.28	BSTO 28/12 BK	0198700000	F.6	DEK 5 FW U5-PE5	0133161118	K.7
AP TOP4SF-FF	0483460000	1.4	BFSC M3X30	0296200000	A.11	BSTO 28/12 MK	0245800000	F.2	DEK 5 FW U6-PE6	0133161119	K.7
AP TOP4SF-FF	0483460000	1.6	BFSC M3X30	0296200000	1.10	BSTO 28/12 MK	0245800000	F.6	DEK 5 FW U7-PE7	0133161120	K.7
AP TW/SS...R5	1333200000	1.6	BFSC M3X35	0308900000	B.28	BSTO 28/12/6,35	0245600000	F.2	DEK 5 FW U8-PE8	0133161121	K.7
AP VLI1.5	1633260000	1.6	BFSC M3X35	0308900000	1.10	BSTO 28/16 MK 4/16	0262100000	F.3	DEK 5 FW U9-PE9	0133161122	K.7
AP VLI1.5 DB	1784150000	1.6	BFSC M3X7 STV1/5	0199700000	1.9	BSTO 28/2 BK	0203500000	F.5	DEK 5 FW X10-Z10	0133261159	K.7
AP VLI1.5/PE	1633320000	1.6	BFSC M4X20	0362300000	B.19	BSTO 28/2 BK	0203500000	F.6	DEK 5 FW X1-21	0133261150	K.7
AP VLI1.5/PE DB	1784160000	1.6	BFSC M4X20	0362300000	A.20	BSTO 28/3 BK	0203700000	F.6	DEK 5 FW X2-22	0133261151	K.7
ASK 1/15	0376860000	E.6	BFSC M4X30	0267100000	A.9	BSTO 28/3 BK	0203700000	F.5	DEK 5 FW X3-23	0133261152	K.7
ASK 1/EN	0474560000	C.7	BFSC M4X30	0267100000	C.4	BSTO 28/4 BK	0197200000	F.5	DEK 5 FW X4-24	0133261153	K.7
ASK 1/EN LD 120K 230VDC	0225660000	C.7	BFSC M4X30	0267100000	B.30	BSTO 28/4 BK	0197200000	F.6	DEK 5 FW X5-25	0133261154	K.7
ASK 1/EN LD 15K 24VDC	0222760000	C.7	BFSC M4X30	0267100000	1.9	BSTO 28/4 MK3/4	0289300000	F.6	DEK 5 FW X6-26	0133261155	K.7
ASK 1/EN LD 10 115VAC	0225660000	C.7	BFSC M4X30	0267100000	B.8	BSTO 28/4 MK3/4	0289300000	F.2	DEK 5 FW X7-27	0133261156	K.7
ASK 1/EN LD 10 230VAC	0225760000	C.7	BFSC M4X30	0267100000	A.5	BSTO 28/6 BK	0197400000	F.5	DEK 5 FW X8-28	0133261157	K.7
ASK 1/EN LD 10 24VAC	0222860000	C.7	BFSC M4X30	0267100000	1.10	BSTO 28/6 BK	0197400000	F.6	DEK 5 FW X9-29	0133261158	K.7
ASK 1/EN LD 10 48VAC	0225360000	C.7	BFSC M4X30	0267100000	H.4	BSTO 28/6 MK	0289500000	F.2	DEK 5 FW 1,3,5-19	0235860000	K.7
ASK 1/EN LD 27K 48VDC	0225260000	C.7	BFSC M4X30	0267100000	B.5	BSTO 28/6 MK	0289500000	F.6	DEK 5 FWZ 1-10	0523060001	K.7
ASK 1/EN LD 33K 60VDC	0226460000	C.7	BFSC M4X30	0267100000	A.4	BSTO 28/8 MK3/8	0284700000	F.6	DEK 5 FWZ 11-20	0523060011	K.7
ASK 1/EN LD 56K 115VDC	0225460000	C.7	BFSC M4X30	0267100000	B.9	BSTO 28/8 MK3/8	0284700000	F.2	DEK 5 FWZ 1-9	1572000000	K.7
AST 1 6.3	0266360000	B.36	BFSC M4X30	0267100000	B.4	BTWZ KLBUE	1742630000	G.8	DEK 5 FWZ 2,4,6-20	0236160000	K.7
AST 1 6.3 KRG	0266320000	B.42	BFSC M4X32 PA/RT	0129100000	B.5	BUE SPLX	9005450000	J.4	DEK 5 FWZ 21,23,25-39	0235960000	K.7
AST 1 6.3/2.8	0478260000	B.36	BFSC M4X32 PA/RT	0129100000	A.5	BZT 1 WS 10/5	1805490000	K.16	DEK 5 FWZ 21-30	0523060021	K.7
AST 1 6.3/2.8 KRG	0478220000	B.42	BFSC M4X32 PA/RT	0129100000	B.4	BZT 1 ZA WS 10/5	1805520000	K.16	DEK 5 FWZ 22,24,26-40	0523060000	K.7
AST 1/35 6.3	0664860000	A.36	BFSC M4X32 PA/RT	0129100000	B.9	BZT 2 WS 10/5	1805480000	K.16	DEK 5 FWZ 31-40	0523060031	K.7
AST 1/35 6.3/2.8	0699660000	A.36	BFSC M4X32 PA/RT	0129100000	A.9	BZT 2 ZA WS 10/5	1805530000	K.16	DEK 5 FWZ 41,43,45-59	0236060000	K.7
AST 3 6.3	0236760000	B.36	BFSC M4X32 PA/RT	0129100000	C.4				DEK 5 FWZ 41-50	0523060041	K.7
AST 3 6.3 KRG	0298020000	B.42	BFSC M4X32 PA/RT	0129100000	B.8				DEK 5 FWZ 42,44,46-60	0236360000	K.7
AST 3 6.3/2.8 KRG	0442420000	B.42	BFSC M4X32 PA/RT	0129100000	A.4				DEK 5 FWZ 51-60	0523060051	K.7
AST 3/35 6.3	0479360000	A.36	BFSC M4X32 PA/RT	0129100000	1.17				DEK 5 FWZ 61-70	0523060061	K.7
AST 3/35 6.3/2.8	0460360000	A.36	BFSC M4X35	0298900000	A.4	CleanUnit PrintJet II	1858950000	K.22	DEK 5 FWZ 71-80	0523060071	K.7
AST 4 SF 6.3/2.8 KRG	0439120000	B.43	BFSC M4X35	0298900000	B.5	CTI 6	9006120000	J.35	DEK 5 FWZ 81-90	0523060081	K.7
AST 4/35 SF 6.3	0479460000	A.37	BFSC M4X35	0298900000	B.4	CTI 6 S	9006210000	J.35	DEK 5 FWZ 91-100	0523060091	K.7
AST 4/35 SF 6.3/2.8	0460460000	A.37	BFSC M4X35	0298900000	A.5				DEK 5 FWZ L1-EIK	0354361203	K.7
AST 5 SF 6.3 KRG	0334520000	B.43	BFSC M4X35	0298900000	B.8				DEK 5 FWZ L1-PE	0354361187	K.7
AST 5 SF 6.3/2.8 KRG	0479220000	B.43	BFSC M4X35	0298900000	1.12	D 2 MK5/2 PA/NA	02				

Type	Order No.	Page	Type	Order No.	Page	Type	Order No.	Page	Type	Order No.	Page
DEK 5 GS P	0132961036	K.7	DEK 5 GW 176	0522660176	K.8	DEK 5 GW 86	0522660086	K.7	DEK 5/3,5 MC GW 1	1755280001	K.8
DEK 5 GS PE	0157261187	K.7	DEK 5 GW 177	0522660177	K.8	DEK 5 GW 87	0522660087	K.7	DEK 5/3,5 MC GW 2	1755280002	K.8
DEK 5 GS Q	0132961037	K.7	DEK 5 GW 178	0522660178	K.8	DEK 5 GW 88	0522660088	K.7	DEK 5/3,5 MC GW 3	1755280003	K.8
DEK 5 GS R	0132961038	K.7	DEK 5 GW 179	0522660179	K.8	DEK 5 GW 89	0522660089	K.7	DEK 5/3,5 MC GW 4	1755280004	K.8
DEK 5 GS S	0132961039	K.7	DEK 5 GW 18	0522660180	K.7	DEK 5 GW 9	0522660090	K.7	DEK 5/3,5 MC GW 5	1755280005	K.8
DEK 5 GS T	0132961040	K.7	DEK 5 GW 180	0522660180	K.8	DEK 5 GW 90	0522660090	K.7	DEK 5/3,5 MC GW 6	1755280006	K.8
DEK 5 GS U	0132961041	K.7	DEK 5 GW 181	0522660181	K.8	DEK 5 GW 91	0522660091	K.7	DEK 5/3,5 MC GW 7	1755280007	K.8
DEK 5 GS V	0132961042	K.7	DEK 5 GW 182	0522660182	K.8	DEK 5 GW 92	0522660092	K.7	DEK 5/3,5 MC GW 8	1755280008	K.8
DEK 5 GS W	0132961043	K.7	DEK 5 GW 183	0522660183	K.8	DEK 5 GW 93	0522660093	K.7	DEK 5/3,5 MC GW 9	1755280009	K.8
DEK 5 GS X	0132961044	K.7	DEK 5 GW 184	0522660184	K.8	DEK 5 GW 94	0522660094	K.7	DEK 5/3,5 MC NEUTRAL	1755270000	K.11
DEK 5 GS Y	0132961045	K.7	DEK 5 GW 185	0522660185	K.8	DEK 5 GW 95	0522660095	K.7	DEK 5/30 MC NEUTRAL	1951920000	K.18
DEK 5 GS Z	0132961046	K.7	DEK 5 GW 186	0522660186	K.8	DEK 5 GW 96	0522660096	K.7	DEK 5/30 MC NEUTRAL	1951920000	K.11
DEK 5 GW	0576260000	K.7	DEK 5 GW 187	0522660187	K.8	DEK 5 GW 97	0522660097	K.7	DEK 5/30 MC SDR	1025680000	K.11
DEK 5 GW -	0576261199	K.8	DEK 5 GW 188	0522660188	K.8	DEK 5 GW 98	0522660098	K.7	DEK 5/5 MC BEDRUCKT	1609810000	K.11
DEK 5 GW +	0576261198	K.8	DEK 5 GW 189	0522660189	K.8	DEK 5 GW 99	0522660099	K.7	DEK 5/5 MC-10 NEUT. BL	1609801693	K.11
DEK 5 GW 1	0522660001	K.7	DEK 5 GW 19	0522660019	K.7	DEK 5 GW A	0522761021	K.8	DEK 5/5 MC-10 NEUT. GE	1609801687	K.11
DEK 5 GW 10	0522660010	K.7	DEK 5 GW 190	0522660190	K.8	DEK 5 GW A KLEIN	0522861047	K.8	DEK 5/5 MC-10 NEUT. GN	1609801688	K.11
DEK 5 GW 100	0522660100	K.7	DEK 5 GW 191	0522660191	K.8	DEK 5 GW B	0522761022	K.8	DEK 5/5 MC-10 NEUT. GR	1609801691	K.11
DEK 5 GW 101	0522660101	K.7	DEK 5 GW 192	0522660192	K.8	DEK 5 GW B KLEIN	0522861048	K.8	DEK 5/5 MC-10 NEUT. RT	1609801686	K.11
DEK 5 GW 102	0522660102	K.7	DEK 5 GW 193	0522660193	K.8	DEK 5 GW BL/SW -	0576291741	K.8	DEK 5/5 MC-10 NEUT. WS	1609801044	K.11
DEK 5 GW 103	0522660103	K.7	DEK 5 GW 194	0522660194	K.8	DEK 5 GW C	0522761023	K.8	DEK 5/5 MC-10 NEUT. WS	1609801044	K.19
DEK 5 GW 104	0522660104	K.7	DEK 5 GW 195	0522660195	K.8	DEK 5 GW C KLEIN	0522861049	K.8	DEK 5/5 MC-10 NEUT. WS	1609801044	K.18
DEK 5 GW 105	0522660105	K.7	DEK 5 GW 196	0522660196	K.8	DEK 5 GW D	0522761024	K.8	DEK 5/5 MC-10 NEUT. WS	1609801044	K.17
DEK 5 GW 106	0522660106	K.7	DEK 5 GW 197	0522660197	K.8	DEK 5 GW D KLEIN	0522861050	K.8	DEK 5/5 MC-10 NEUT. WS	1609801044	K.16
DEK 5 GW 107	0522660107	K.7	DEK 5 GW 198	0522660198	K.8	DEK 5 GW E	0522761025	K.8	DEK 5/5 PLUS MC GE	1907520000	K.11
DEK 5 GW 108	0522660108	K.7	DEK 5 GW 199	0522660199	K.8	DEK 5 GW E KLEIN	0522861051	K.8	DEK 5/5 PLUS MC NEUTRAL	1854490000	K.11
DEK 5 GW 109	0522660109	K.7	DEK 5 GW 20	0522660020	K.7	DEK 5 GW ERDE	0576261202	K.8	DEK 5/5 PLUS MC SONDERDR.	1854500000	K.11
DEK 5 GW 11	0522660011	K.7	DEK 5 GW 20	0522660020	K.7	DEK 5 GW ERDE I.K.R.	0576261203	K.8	DEK 5/6 MC BEDRUCKT	1609830000	K.11
DEK 5 GW 110	0522660110	K.7	DEK 5 GW 200	0522660200	K.8	DEK 5 GW F	0522761026	K.8	DEK 5/6 MC NEUTRAL	1609820000	K.11
DEK 5 GW 111	0522660111	K.7	DEK 5 GW 21	0522660201	K.7	DEK 5 GW F KLEIN	0522861052	K.8	DEK 5/6 PLUS MC NE WS	1011320000	K.11
DEK 5 GW 112	0522660112	K.7	DEK 5 GW 22	0522660202	K.7	DEK 5 GW G	0522761027	K.8	DEK 5/6,5 MC BEDRUCKT	1609850000	K.11
DEK 5 GW 113	0522660113	K.7	DEK 5 GW 23	0522660203	K.7	DEK 5 GW G KLEIN	0522861053	K.8	DEK 5/6,5 MC NEUTRAL	1609840000	K.11
DEK 5 GW 114	0522660114	K.7	DEK 5 GW 24	0522660204	K.7	DEK 5 GW H	0522761028	K.8	DEK 5/7,5 MC NEUTRAL	1720620000	K.11
DEK 5 GW 115	0522660115	K.7	DEK 5 GW 25	0522660205	K.7	DEK 5 GW H KLEIN	0522861054	K.8	DEK 5/7,5 MC SONDERDR.	1770490000	K.11
DEK 5 GW 116	0522660116	K.7	DEK 5 GW 26	0522660206	K.7	DEK 5 GW I	0522761029	K.8	DEK 5/8 MC Neutral	1856740000	K.11
DEK 5 GW 117	0522660117	K.7	DEK 5 GW 27	0522660207	K.7	DEK 5 GW I KLEIN	0522861055	K.8	DEK 5/8 MC Sonderdruck	1856750000	K.11
DEK 5 GW 118	0522660118	K.7	DEK 5 GW 28	0522660208	K.7	DEK 5 GW J	0522761030	K.8	DEK 5/8 MC NEUTRAL	0468591693	K.8
DEK 5 GW 119	0522660119	K.7	DEK 5 GW 29	0522660209	K.7	DEK 5 GW J KLEIN	0522861056	K.8	DEK 5 BR NEUTRAL	0468591692	K.8
DEK 5 GW 12	0522660012	K.7	DEK 5 GW 3	0522660003	K.7	DEK 5 GW K	0522761031	K.8	DEK 6 FS 101-150	0468760101	K.8
DEK 5 GW 120	0522660120	K.7	DEK 5 GW 30	0522660030	K.7	DEK 5 GW K KLEIN	0522861057	K.8	DEK 6 FS 1-50	0468760001	K.8
DEK 5 GW 121	0522660121	K.7	DEK 5 GW 31	0522660031	K.7	DEK 5 GW L	0522761032	K.8	DEK 6 FS 151-200	0468760151	K.8
DEK 5 GW 122	0522660122	K.7	DEK 5 GW 32	0522660032	K.7	DEK 5 GW L KLEIN	0522861058	K.8	DEK 6 FS 201-250	0468760201	K.8
DEK 5 GW 123	0522660123	K.7	DEK 5 GW 33	0522660033	K.7	DEK 5 GW L1	0522361075	K.8	DEK 6 FS 251-300	0468760251	K.8
DEK 5 GW 124	0522660124	K.7	DEK 5 GW 34	0522660034	K.7	DEK 5 GW L2	0522361076	K.8	DEK 6 FS 301-350	0468760301	K.8
DEK 5 GW 125	0522660125	K.7	DEK 5 GW 35	0522660035	K.7	DEK 5 GW L3	0522361077	K.8	DEK 6 FS 351-400	0468760351	K.8
DEK 5 GW 126	0522660126	K.7	DEK 5 GW 36	0522660036	K.7	DEK 5 GW M	0522761033	K.8	DEK 6 FS 401-450	0468760401	K.8
DEK 5 GW 127	0522660127	K.7	DEK 5 GW 37	0522660037	K.7	DEK 5 GW M KLEIN	0522861059	K.8	DEK 6 FS 451-500	0468760451	K.8
DEK 5 GW 128	0522660128	K.7	DEK 5 GW 38	0522660038	K.7	DEK 5 GW Mp	0537261235	K.8	DEK 6 FS 501-550	0468760501	K.8
DEK 5 GW 129	0522660129	K.7	DEK 5 GW 39	0522660039	K.7	DEK 5 GW N	0522761034	K.8	DEK 6 FS 51-100	0468760051	K.8
DEK 5 GW 13	0522660013	K.7	DEK 5 GW 4	0522660004	K.7	DEK 5 GW N KLEIN	0522861060	K.8	DEK 6 FS 551-600	0468760551	K.8
DEK 5 GW 130	0522660130	K.7	DEK 5 GW 40	0522660040	K.7	DEK 5 GW O	0522761035	K.8	DEK 6 FS 601-650	0468760601	K.8
DEK 5 GW 131	0522660131	K.7	DEK 5 GW 41	0522660041	K.7	DEK 5 GW O KLEIN	0522861061	K.8	DEK 6 FS 651-700	0468760651	K.8
DEK 5 GW 132	0522660132	K.7	DEK 5 GW 42	0522660042	K.7	DEK 5 GW P	0522761036	K.8	DEK 6 FS 701-750	0468760701	K.8
DEK 5 GW 133	0522660133	K.7	DEK 5 GW 43	0522660043	K.7	DEK 5 GW P KLEIN	0522861062	K.8	DEK 6 FS 751-800	0468760751	K.8
DEK 5 GW 134	0522660134	K.7	DEK 5 GW 44	0522660044	K.7	DEK 5 GW PE	0537261187	K.8	DEK 6 FS 801-850	0468760801	K.8
DEK 5 GW 135	0522660135	K.7	DEK 5 GW 45	0522660045	K.7	DEK 5 GW PEN	0537261188	K.8	DEK 6 FS 851-900	0468760851	K.8
DEK 5 GW 136	0522660136	K.7	DEK 5 GW 46	0522660046	K.7	DEK 5 GW Q	0522761037	K.8	DEK 6 FS 901-950	0468760901	K.8
DEK 5 GW 137	0522660137	K.7	DEK 5 GW 47	0522660047	K.7	DEK 5 GW Q KLEIN	0522861063	K.8	DEK 6 FS 951-999	0468760951	K.8
DEK 5 GW 138	0522660138	K.7	DEK 5 GW 48	0522660048	K.7	DEK 5 GW R	0522761038	K.8	DEK 6 FSZ 1-10	0133360001	K.8
DEK 5 GW 139	0522660139	K.7	DEK 5 GW 49	0522660049	K.7	DEK 5 GW R KLEIN	0522861064	K.8	DEK 6 FSZ 11-20	0133360011	K.8
DEK 5 GW 14	0522660014	K.7	DEK 5 GW 5	0522660005	K.7	DEK 5 GW RT/SW +	0576291737	K.8	DEK 6 FSZ 21-30	0133360021	K.8
DEK 5 GW 140	0522660140	K.7	DEK 5 GW 50	0522660050	K.7	DEK 5 GW S	0522761039	K.8	DEK 6 FSZ 31-40	0133360031	K.8
DEK 5 GW 141	0522660141	K.7	DEK 5 GW 51	0522660051	K.7	DEK 5 GW S KLEIN	0522861065	K.8	DEK 6 FSZ 41-50	0133360041	K.8
DEK 5 GW 142	0522660142	K.7	DEK 5 GW 52	0522660052	K.7	DEK 5 GW T	0522761040	K.8	DEK 6 FSZ 51-60	0133360051	K.8
DEK 5 GW 143	0522660143	K.7	DEK 5 GW 53	0522660053	K.7	DEK 5 GW T KLEIN	0522861066	K.8	DEK 6 FSZ 61-70	0133360061	K.8
DEK 5 GW 144	0522660144	K.7	DEK 5 GW 54	0522660054	K.7	DEK 5 GW U	0522761041	K.8	DEK 6 FSZ 71-80	0133360071	K.8
DEK 5 GW 145	0522660145	K.7	DEK 5 GW 55	0522660055	K.7	DEK 5 GW U KLEIN	0522861067	K.8	DEK 6 FSZ 81-90	0133360081	K.8
DEK 5 GW 146	0522660146	K.7	DEK 5 GW 56	0522660056	K.7	DEK 5 GW V	0522761042	K.8	DEK 6 FSZ 91-100	0133360091	K.8
DEK 5 GW 147	0522660147	K.7	DEK 5 GW 57	0522660057	K.7	DEK 5 GW V KLEIN	0522861068	K.8	DEK 6 FW 1,3,5...99	1358660000	K.8
DEK 5 GW 148	0522660148	K.7	DEK 5 GW 58	0522660058	K.7	DEK 5 GW W	0522761043	K.8	DEK 6 FW 101-150	0468660101	K.8
DEK 5 GW 149	0522660149	K.7	DEK 5 GW 59	0522660059	K.7	DEK 5 GW W KLEIN	0522861069	K.8	DEK 6 FW 1-5 (10X)	0688660000	K.8
DEK 5 GW 15	0522660015	K.7	DEK 5 GW 6	0522660006	K.7	DEK 5 GW W-STROM	0576261215	K.8	DEK 6 FW 1-50	0468660001	K.8
DEK 5 GW 150	0522660150	K.7	DEK 5 GW 60	0522660060	K.7	DEK 5 GW X	0522761044	K.8	DEK 6 FW 151-200	0468660151	K.8
DEK 5 GW 151	0522660151	K.7	DEK 5 GW 61	0522660061	K.7	DEK 5 GW X KLEIN	0522861070	K.8	DEK 6 FW 2,4...100	1358760000	K.8
DEK 5 GW 152	0522660152	K.7	DEK 5 GW 62	0522660062	K.7	DEK 5 GW Y	0522761045	K.8	DEK 6 FW 201-250	0468660201	K.8
DEK 5 GW 153	0522660153	K.7	DEK 5 GW 63	0522660063	K.7	DEK 5 GW Y KLEIN	0522861071	K.8	DEK 6 FW 251-300	0468660251	K.8
DEK 5 GW 154	0522660154	K.7	DEK 5 GW 64	0522660064	K.7	DEK 5 GW Z	0522761046	K.8	DEK 6 FW 301-350	0468660301	K.8
DEK 5 GW 155	0522660155	K.7	DEK 5 GW 65	0522660065	K.7	DEK 5 GW Z KLEIN	0522861072	K.8	DEK 6 FW 351-400	0468660351	K.8
DEK 5 GW 156	0522660156	K.7	DEK 5 GW 66	0522660066	K.7	DEK 5 NEUTRAL	0473360000	K.8	DEK 6 FW 401-450	0468660401	K.8
DEK 5 GW 157	0522660157	K.7	DEK 5 GW 67	0522660067	K.7	DEK 5 OR NEUTRAL	0473391690	K.8	DEK 6 FW 451-500	0468660451	K.8
DEK 5 GW 158	0522660158	K.7	DEK 5 GW 68	0522660068	K.7	DEK 5 RT NEUTRAL	0473391686	K.8	DEK 6 FW 501-550	0468660501	K.8
DEK 5 GW 159	0522660159	K.7	DEK 5 GW 69	0522660069	K.7	DEK 5 SW NEUTRAL					

Type	Order No.	Page	Type	Order No.	Page	Type	Order No.	Page	Type	Order No.	Page
DEK 6 FWZ 161-170	0518960161	K.8	DEK 6 GW 79	0526960079	K.9	DEK 6,5 NEUTRAL	0468060000	K.9	DKT 4/35	0687460000	A.19
DEK 6 FWZ 171-180	0518960171	K.8	DEK 6 GW 8	0526960008	K.8	DEK 6,5 OR NEUTRAL	0468091690	K.9	DKT 4/35 PT100	8014720000	A.56
DEK 6 FWZ 181-190	0518960181	K.8	DEK 6 GW 80	0526960080	K.9	DEK 6,5 RT NEUTRAL	0468091686	K.9	DKT 4V 2STB	1304860000	B.17
DEK 6 FWZ 191-200	0518960191	K.8	DEK 6 GW 81	0526960081	K.9	DEK 6,5 SW NEUTRAL	0468091694	K.9	DKT 4V/35 2STB	1304960000	A.19
DEK 6 FWZ 201-210	0518960201	K.8	DEK 6 GW 82	0526960082	K.9	DEK 6,5 VI NEUTRAL	0468091689	K.9	DMS 2 Set	0664600000	J.11
DEK 6 FWZ 21-30	0518960021	K.8	DEK 6 GW 83	0526960083	K.9	DEK 8 BEDR./FARBIG	1289690000	K.9	DMS 3	9007440000	J.10
DEK 6 FWZ 31-40	0518960031	K.8	DEK 6 GW 84	0526960084	K.9	DEK 8 FS 1-50 TAMPOPR.	1653350001	K.9	DMS 3 SET 1	9007470000	J.10
DEK 6 FWZ 41-50	0518960041	K.8	DEK 6 GW 85	0526960085	K.9	DEK 8 FS 51-100 TAMPOP.	1653350005	K.9	DMS 3 SET 2	9007480000	J.10
DEK 6 FWZ 51-60	0518960051	K.8	DEK 6 GW 86	0526960086	K.9	DEK 8 FSZ 1-10	1289660001	K.9	DMS MANUELL 0,5-1,7	9918370000	J.18
DEK 6 FWZ 61-70	0518960061	K.8	DEK 6 GW 87	0526960087	K.9	DEK 8 FSZ 11-20	1289660011	K.9	DMS MANUELL 2,0-8,0	9918380000	J.18
DEK 6 FWZ 71-80	0518960071	K.8	DEK 6 GW 88	0526960088	K.9	DEK 8 FSZ 21-30	1289660021	K.9	DMS MANUELL 0,5-1,7	9918390000	J.19
DEK 6 FWZ 81-90	0518960081	K.8	DEK 6 GW 89	0526960089	K.9	DEK 8 FSZ 31-40	1289660031	K.9	DMSI MANUELL 2,0-8,0	9918400000	J.19
DEK 6 FWZ 91-100	0518960091	K.8	DEK 6 GW 9	0526960009	K.8	DEK 8 FSZ 41-50	1289660041	K.9	DQS 2 1D PS2,3 AG	0471460000	I.13
DEK 6 FWZ L1-ERDE I.KRE	0631961203	K.8	DEK 6 GW 90	0526960090	K.9	DEK 8 FSZ 51-60	1289660051	K.9	DQS 2 PS2,3 AG M.BRUECK	0471560000	I.13
DEK 6 FWZ L1-PE	0631961187	K.8	DEK 6 GW 91	0526960091	K.9	DEK 8 FSZ 61-70	1289660061	K.9	DQS 2 PS2,3 O.BATE	0471660000	I.13
DEK 6 GE NEUTRAL	0468591687	K.8	DEK 6 GW 92	0526960092	K.9	DEK 8 FSZ 71-80	1289660071	K.9	DS 12.5 SAK10	0207630000	I.12
DEK 6 GN NEUTRAL	0468591688	K.8	DEK 6 GW 93	0526960093	K.9	DEK 8 FSZ 81-90	1289660081	K.9	DS 12.5 SAK6N	0207730000	I.12
DEK 6 GR NEUTRAL	0468591691	K.8	DEK 6 GW 94	0526960094	K.9	DEK 8 FSZ 91-100	1289660091	K.9	DS 14 SAK4	0207530000	I.12
DEK 6 GW -	1318061199	K.9	DEK 6 GW 95	0526960095	K.9	DEK 8 FW 1-50 TAMPOPR.	1653340001	K.9	DS 9 SAK2.5	0330930000	I.12
DEK 6 GW +	1318061198	K.9	DEK 6 GW 96	0526960096	K.9	DEK 8 FW 51-100 TAMPOP.	1653340051	K.9	DSTV VH 6.5	0286400000	I.10
DEK 6 GW 0	0526961000	K.8	DEK 6 GW 97	0526960097	K.9	DEK 8 FWZ 101-110	1276960101	K.9			
DEK 6 GW 1	0526960001	K.8	DEK 6 GW 98	0526960098	K.9	DEK 8 FWZ 1-10	1276960011	K.9			
DEK 6 GW 10	0526960010	K.8	DEK 6 GW 99	0526960099	K.9	DEK 8 FWZ 111-120	1276960111	K.9			
DEK 6 GW 100	0526960100	K.9	DEK 6 GW BL/SW -	1318091741	K.9	DEK 8 FWZ 11-20	1276960011	K.9	E 14/10A RT	0328400000	B.24
DEK 6 GW 11	0526960011	K.8	DEK 6 GW ERDE	1318061202	K.9	DEK 8 FWZ 121-130	1276960121	K.9	E 14/10A RT	0328400000	A.28
DEK 6 GW 12	0526960012	K.8	DEK 6 GW ERDE I.KR.	1318061203	K.9	DEK 8 FWZ 131-140	1276960131	K.9	E 14/10A RT	0328400000	B.26
DEK 6 GW 13	0526960013	K.8	DEK 6 GW PE	1318061187	K.9	DEK 8 FWZ 141-150	1276960141	K.9	E 14/10A RT	0328400000	A.28
DEK 6 GW 14	0526960014	K.8	DEK 6 GW RT/SW +	1318091737	K.9	DEK 8 FWZ 21-30	1276960021	K.9	E 14/16A GR	0328500000	B.24
DEK 6 GW 15	0526960015	K.8	DEK 6 NEUTRAL	0468590000	K.8	DEK 8 FWZ 31-40	1276960031	K.9	E 14/16A GR	0328500000	B.26
DEK 6 GW 16	0526960016	K.8	DEK 6 NEUTRAL	0468590000	K.8	DEK 8 FWZ 41-50	1276960041	K.9	E 14/16A GR	0328500000	A.28
DEK 6 GW 17	0526960017	K.8	DEK 6 OR NEUTRAL	0468591690	K.9	DEK 8 FWZ 51-60	1276960051	K.9	E 14/16A GR	0328500000	A.26
DEK 6 GW 18	0526960018	K.8	DEK 6 RT NEUTRAL	0468591686	K.9	DEK 8 FWZ 61-70	1276960061	K.9	E 14/2A RS	0137400000	A.28
DEK 6 GW 19	0526960019	K.8	DEK 6 SW NEUTRAL	0468591694	K.9	DEK 8 FWZ 71-80	1276960071	K.9	E 14/2A RS	0137400000	A.26
DEK 6 GW 20	0526960020	K.8	DEK 6 VI NEUTRAL	0468591689	K.9	DEK 8 FWZ 81-90	1276960081	K.9	E 14/2A RS	0137400000	B.26
DEK 6 GW 200	0526960200	K.9	DEK 6,5 BL NEUTRAL	0468091693	K.9	DEK 8 FWZ 91-100	1276960091	K.9	E 14/2A RS	0137400000	B.24
DEK 6 GW 21	0526960021	K.8	DEK 6,5 FS 101-150	0468260101	K.9	DEK 8 GE NEUTRAL	1277091687	K.9	E 14/4A BR	0137500000	A.26
DEK 6 GW 22	0526960022	K.8	DEK 6,5 FS 1-50	0468260001	K.9	DEK 8 GN NEUTRAL	1277091688	K.9	E 14/4A BR	0137500000	B.24
DEK 6 GW 23	0526960023	K.8	DEK 6,5 FS 151-200	0468260151	K.9	DEK 8 NEUTRAL	1277091688	K.9	E 14/4A BR	0137500000	B.26
DEK 6 GW 24	0526960024	K.8	DEK 6,5 FS 201-250	0468260201	K.9	DEK 8 OR NEUTRAL	1277091690	K.9	E 14/4A BR	0137500000	A.28
DEK 6 GW 25	0526960025	K.8	DEK 6,5 FS 251-300	0468260251	K.9	DEK 8 RT NEUTRAL	1277091686	K.9	E 14/4A BR	0137500000	A.26
DEK 6 GW 26	0526960026	K.8	DEK 6,5 FS 301-350	0468260301	K.9	DEK 8 SONDERDR.FARBIG	1326690000	K.9	E 14/6A GN	0328300000	B.24
DEK 6 GW 27	0526960027	K.8	DEK 6,5 FS 351-400	0468260351	K.9	DEK 8 SONDERDR.WEISS	1326660000	K.9	E 14/6A GN	0328300000	A.28
DEK 6 GW 28	0526960028	K.8	DEK 6,5 FS 401-450	0468260401	K.9	DEK 8 VI NEUTRAL	1277091689	K.9	E 14/6A GN	0328300000	B.26
DEK 6 GW 29	0526960029	K.8	DEK 6,5 FS 451-500	0468260451	K.9	DK 4	0355460000	B.10	E 16/10A RT TNDZ	0208500000	A.26
DEK 6 GW 3	0526960003	K.8	DEK 6,5 FS 501-550	0468260501	K.9	DK 4 BL	0355480000	B.10	E 16/10A RT TNDZ	0208500000	B.24
DEK 6 GW 30	0526960030	K.8	DEK 6,5 FS 551-600	0468260551	K.9	DK 4 Q/EN	1907040000	C.4	E 16/10A RT TNDZ	0208500000	A.28
DEK 6 GW 31	0526960031	K.8	DEK 6,5 FS 601-650	0468260601	K.9	DK 4 Q/EN BL	1907030000	C.4	E 16/10A RT TNDZ	0208500000	B.26
DEK 6 GW 32	0526960032	K.8	DEK 6,5 FS 651-700	0468260651	K.9	DK 4 Q/EN	1907020000	C.5	E 16/10A RT TNDZ	0208500000	A.28
DEK 6 GW 33	0526960033	K.8	DEK 6,5 FS 701-750	0468260701	K.9	DK 4 SW 1X1	0536560000	B.38	E 16/16A GR TNDZ	0208600000	A.26
DEK 6 GW 34	0526960034	K.8	DEK 6,5 FS 751-800	0468260751	K.9	DK 4/32 1D 1K5	0855260000	B.60	E 16/16A GR TNDZ	0208600000	B.26
DEK 6 GW 35	0526960035	K.8	DEK 6,5 FS 801-850	0468260801	K.9	DK 4/32 1D CSA A1	0484060000	B.58	E 16/16A GR TNDZ	0208600000	B.24
DEK 6 GW 36	0526960036	K.8	DEK 6,5 FS 851-900	0468260851	K.9	DK 4/32 1D CSA A2	0467960000	B.59	E 16/20A BL TNDZ	0208700000	B.24
DEK 6 GW 37	0526960037	K.8	DEK 6,5 FS 901-950	0468260901	K.9	DK 4/32 1D CSA GET.SCH.	0544460000	B.58	E 16/20A BL TNDZ	0208700000	A.28
DEK 6 GW 38	0526960038	K.8	DEK 6,5 FS 951-999	0468260951	K.9	DK 4/32 2D A1	0663960000	B.60	E 16/20A BL TNDZ	0208700000	A.26
DEK 6 GW 39	0526960039	K.8	DEK 6,5 FSZ 1-10	0407360001	K.9	DK 4/32 2D CSA A2	0523760000	B.59	E 16/20A BL TNDZ	0208700000	B.26
DEK 6 GW 4	0526960004	K.8	DEK 6,5 FSZ 11-20	0407360011	K.9	DK 4/32 2D CSA GET.SCH.	0642760000	B.59	E 16/25A GE TNDZ	0208800000	B.24
DEK 6 GW 40	0526960040	K.8	DEK 6,5 FSZ 21-30	0407360021	K.9	DK 4/32 GL 100K 115VAC	0569560000	B.57	E 16/25A GE TNDZ	0208800000	A.26
DEK 6 GW 41	0526960041	K.8	DEK 6,5 FSZ 31-40	0407360031	K.9	DK 4/32 LD GR 24VDC	0646560000	B.56	E 16/25A GE TNDZ	0208800000	B.26
DEK 6 GW 42	0526960042	K.8	DEK 6,5 FSZ 41-50	0407360041	K.9	DK 4/32 LD ROT 24VDC	0210160000	B.57	E 16/25A GE TNDZ	0208800000	A.28
DEK 6 GW 43	0526960043	K.8	DEK 6,5 FSZ 51-60	0407360051	K.9	DK 4/32 LD ROT 24VDC A1	0495360000	B.56	E 18/20A BL	0361300000	A.28
DEK 6 GW 44	0526960044	K.8	DEK 6,5 FSZ 61-70	0407360061	K.9	DK 4/32 LD ROT 24VDC A2	0474460000	B.56	E 18/20A BL	0361300000	B.25
DEK 6 GW 45	0526960045	K.8	DEK 6,5 FSZ 71-80	0407360071	K.9	DK 4/32 RC 220R/220N	0692160000	B.61	E 18/20A BL	0361300000	A.27
DEK 6 GW 46	0526960046	K.8	DEK 6,5 FSZ 81-90	0407360081	K.9	DK 4/35	0527660000	A.12	E 18/20A BL	0361300000	B.26
DEK 6 GW 47	0526960047	K.8	DEK 6,5 FSZ 91-100	0407360091	K.9	DK 4/35 1D5 1K5 GET.SCH.	0396960000	A.55	E 18/20A BL	0361400000	B.26
DEK 6 GW 48	0526960048	K.8	DEK 6,5 FW 101-150	0468160101	K.9	DK 4/35 1D A1	0538960000	A.53	E 18/25A GE	0361400000	B.25
DEK 6 GW 49	0526960049	K.8	DEK 6,5 FW 151-200	0468160151	K.9	DK 4/35 1D A1 BL	0538980000	A.53	E 18/25A GE	0361400000	A.28
DEK 6 GW 50	0526960050	K.8	DEK 6,5 FW 201-250	0468160201	K.9	DK 4/35 1D A2	0538960000	A.54	E 18/25A GE	0361400000	A.27
DEK 6 GW 51	0526960051	K.8	DEK 6,5 FW 251-300	0468160251	K.9	DK 4/35 1D GET.SCH.	0396360000	A.53	E 18/35A SW	0361500000	B.26
DEK 6 GW 52	0526960052	K.8	DEK 6,5 FW 301-350	0468160301	K.9	DK 4/35 2D GET.SCH. A1	0396660000	A.54	E 18/35A SW	0361500000	A.28
DEK 6 GW 53	0526960053	K.8	DEK 6,5 FW 351-400	0468160351	K.9	DK 4/35 2D GET.SCH. A2	0396760000	A.55	E 18/50A WS	0361600000	B.25
DEK 6 GW 54	0526960054	K.8	DEK 6,5 FW 401-450	0468160401	K.9	DK 4/35 LD GR 24VDC	0396860000	A.55	E 18/50A WS	0361600000	A.27
DEK 6 GW 55	0526960055	K.8	DEK 6,5 FW 451-500	0468160451	K.9	DK 4/35 BL	0527680000	A.12	E 18/50A WS	0361600000	A.28
DEK 6 GW 56	0526960056	K.8	DEK 6,5 FW 501-550	0468160501	K.9	DK 4/35 GL 1D I1,0A	1111160000	A.52	E 18/50A WS	0361600000	B.26
DEK 6 GW 57	0526960057	K.8	DEK 6,5 FW 551-600	0468160551	K.9	DK 4/35 LD 1D ROT 24VAC	0395960000	A.51	E 18/50A WS	0361600000	B.26
DEK 6 GW 58	0526960058	K.8	DEK 6,5 FW 601-650	0468160601	K.9	DK 4/35 LD GR 24VDC	0210060000	A.51	E 18/63A KU	0361700000	A.27
DEK 6 GW 59	0526960059	K.8	DEK 6,5 FW 651-700	0468160651	K.9	DK 4/35 LD GR 24VDC	0210460000	A.51	E 18/63A KU	0361700000	B.25
DEK 6 GW 60	0526960060	K.8	DEK 6,5 FW 701-750	0468160701	K.9	DK 4/35 LD GR 24VDC	0395460000	A.50	E 18/63A KU	0361700000	A.28
DEK 6 GW 61	0526960061	K.8	DEK 6,5 FW 751-800	0468160751	K.9	DK 4/35 LD ROT 24VDC	0395760000	A.50	EK 10	0354660000	B.13
DEK 6 GW 62	0526960062	K.8	DEK 6,5 FW 801-850	0468160801	K.9	DK 4/35 LD ROT 24VDC	0210260000	A.51	EK 10/35	0661360000	A.15

Type	Order No.	Page
EP 1 SAKG28/32 HP/DBR	0205100000	B.50
EP 1 SAKG28/32 HP/DBR	0205100000	B.47
EP 1 SAKG28/32 HP/DBR	0205100000	I.4
EP 1 SAKG28/32 HP/DBR	0205100000	B.48
EP 1 SAKG28/32 HP/DBR	0205100000	B.49
EP 1 SAKG28/32 HP/DBR	0205100000	B.46
EP 1 SAKG28/32 HP/TF/GE	0205200000	B.46
EP 1 SAKG28/32 HP/TF/GE	0205200000	B.47
EP 1 SAKG28/32 HP/TF/GE	0205200000	B.48
EP 1 SAKG28/32 HP/TF/GE	0205200000	B.49
EP 1 SAKG28/32 HP/TF/GE	0205200000	B.50
EP 1 SAKG28/32 HP/TF/GE	0205200000	I.4
EP 1 SAKG32/35 HP/DBR	0180500000	A.44
EP 1 SAKG32/35 HP/DBR	0180500000	B.49
EP 1 SAKG32/35 HP/DBR	0180500000	A.43
EP 1 SAKG32/35 HP/DBR	0180500000	I.4
EP 1 SAKG32/35 HP/TF/GE	0180600000	I.4
EP 1 SAKG32/35 HP/TF/GE	0180600000	A.44
EP 1 SAKG32/35 HP/TF/GE	0180600000	A.43
EP 1 SAKG32/35 HP/TF/GE	0180600000	B.49
EP 1/BW SAKG28/32 HP/DB	0271800000	I.5
EP 1/BW SAKG32/35 HP/DB	1381600000	I.5
EP 2 SAKG46/32 HP/DBR	0205300000	B.52
EP 2 SAKG46/32 HP/DBR	0205300000	B.51
EP 2 SAKG46/32 HP/DBR	0205300000	B.49
EP 2 SAKG46/32 HP/DBR	0205300000	B.48
EP 2 SAKG46/32 HP/DBR	0205300000	B.53
EP 2 SAKG46/32 HP/DBR	0205300000	B.50
EP 2 SAKG46/32 HP/DBR	0205400000	B.50
EP 2 SAKG46/32 HP/DBR	0205400000	B.49
EP 2 SAKG46/32 HP/TF/GE	0205400000	B.51
EP 2 SAKG46/32 HP/TF/GE	0205400000	B.52
EP 2 SAKG46/32 HP/TF/GE	0205400000	B.48
EP 2 SAKG46/32 HP/TF/GE	0205400000	B.53
EP 2 SAKG46/32 HP/TF/GE	0205400000	I.4
EP 2 SAKG46/35 HP/DBR	0180700000	A.47
EP 2 SAKG46/35 HP/DBR	0180700000	A.46
EP 2 SAKG46/35 HP/DBR	0180700000	A.45
EP 2 SAKG46/35 HP/DBR	0180700000	A.44
EP 2 SAKG46/35 HP/DBR	0180700000	I.4
EP 2 SAKG46/35 HP/DBR	0180700000	A.42
EP 2 SAKG46/35 HP/DBR	0180700000	A.43
EP 2 SAKG46/35 HP/TF/GE	0180800000	A.44
EP 2 SAKG46/35 HP/TF/GE	0180800000	A.47
EP 2 SAKG46/35 HP/TF/GE	0180800000	A.45
EP 2 SAKG46/35 HP/TF/GE	0180800000	A.46
EP 2 SAKG46/35 HP/TF/GE	0180800000	I.4
EP 2 SAKG46/35 HP/TF/GE	0180800000	A.43
EP 2 SAKG46/35 HP/TF/GE	0180800000	A.42
EP 2/BW SAKG46/32 HP/DB	0271900000	I.5
EP 2/BW SAKG46/35 HP/DBR	0182000000	I.5
ESCH 1 M	0280300000	H.3
ESO 15 BOGEN DIN A4	1636510000	K.19
ESO 5 DIN A4 GELB BOG.	1631350000	K.17
ESO 5 DIN A4 WEISS BOG.	1607710000	K.17
ESO 5 POLY.GELB A4-BOG.	1670380000	K.17
ESO 5 POLY.WEISS A4-BOG.	1670370000	K.17
ESO 5 S DIN A4-BOGEN	1631920000	K.17
ESO 7 A4-BOGEN GELB	1634780000	K.17
ESO 7 A4-BOGEN GELB	1634780000	K.19
ESO 7 A4-BOGEN WEISS	1607720000	K.17
ESO 7 A4-BOGEN WEISS	1607720000	K.19
ESO 7 POLY.GELB A4-BOG.	1670400000	K.17
ESO 7 POLY.GELB A4-BOG.	1670400000	K.19
ESO 7 POLY.WEISS A4-BOG.	1670390000	K.19
ESO 7 POLY.WEISS A4-BOG.	1670390000	K.17
EW 15	0382860000	H.13
EW 15	0382860000	E.3
EW 15	0382860000	E.2
EW 15/2	1071900000	H.13
EW 35	0383560000	A.56
EW 35	0383560000	C.8
EW 35	0383560000	H.13
EW 35	0383560000	A.57
EW 35 GR 7032	0383530000	H.13
EW 35/SCHA/M3	0258660000	I.12
EWK 1	0206160000	H.13
EWK 1	0206160000	B.62
EWK 1	0206160000	C.8
EWK 1 ALT	0495160000	H.13
EWK 2	0199360000	H.13
EWK 2/SCHA/M3/L	0258760000	I.12
EWK AKA 2.5	0348660000	H.13

Type	Order No.	Page
FK 4	1678650000	I.14
FKSC M5x8 D9/SW2.5	0295900000	H.14
FKSC M6x12 D9/SW3	0353500000	H.14
FKSC M6x8 D9/SW3	0642600000	H.14
FM 4.2/TS35	1724580000	H.15
FM 4/TS35	0687900000	G.10
FM 4/TS35	0687900000	H.15
FM 5/TS35	0636800000	H.15
FM 6/TS35	0636900000	H.15
FZS 2/4 RT/80 SAKT4	1276300000	I.14

G

Type	Order No.	Page
G 20/0.10A/F	0430300000	B.26
G 20/0.10A/F	0430300000	A.23
G 20/0.10A/F	0430300000	A.22
G 20/0.10A/F	0430300000	B.20
G 20/0.10A/F	0430300000	B.21
G 20/0.10A/F	0430300000	A.28
G 20/0.20A/F	0430400000	A.28
G 20/0.20A/F	0430400000	A.23
G 20/0.20A/F	0430400000	B.26
G 20/0.20A/F	0430400000	A.22
G 20/0.20A/F	0430400000	B.20
G 20/0.20A/F	0430400000	B.21
G 20/0.25A/F	0430500000	B.26
G 20/0.25A/F	0430500000	A.22
G 20/0.25A/F	0430500000	A.28
G 20/0.25A/F	0430500000	B.20
G 20/0.25A/F	0430500000	A.23
G 20/0.25A/F	0430600000	A.28
G 20/0.25A/F	0430600000	B.21
G 20/0.50A/F	0430600000	B.20
G 20/0.50A/F	0430600000	A.23
G 20/0.50A/F	0430600000	B.26
G 20/0.50A/F	0430600000	A.22
G 20/0.63A/F	0439000000	B.26
G 20/0.63A/F	0439000000	A.22
G 20/0.63A/F	0439000000	B.20
G 20/0.63A/F	0439000000	A.28
G 20/1.00A/F	0430700000	B.20
G 20/1.00A/F	0430700000	A.22
G 20/1.00A/F	0430700000	A.28
G 20/1.00A/F	0430700000	B.26
G 20/1.00A/F	0430700000	B.21
G 20/1.60A/F	0430800000	B.20
G 20/1.60A/F	0430800000	B.21
G 20/1.60A/F	0430800000	A.23
G 20/1.60A/F	0430800000	A.22
G 20/1.60A/F	0430800000	B.28
G 20/1.60A/F	0430800000	A.26
G 20/2.00A/F	0430900000	A.28
G 20/2.00A/F	0430900000	B.20
G 20/2.00A/F	0430900000	B.21
G 20/2.00A/F	0430900000	A.23
G 20/2.00A/F	0430900000	A.26
G 20/2.00A/F	0430900000	A.22
G 20/2.50A/F	0431000000	B.20
G 20/2.50A/F	0431000000	A.22
G 20/2.50A/F	0431000000	B.26
G 20/2.50A/F	0431000000	A.28
G 20/2.50A/F	0431000000	B.21
G 20/3.15A/F	0431100000	B.20
G 20/3.15A/F	0431100000	A.22
G 20/3.15A/F	0431100000	A.28
G 20/3.15A/F	0431100000	B.21
G 20/3.15A/F	0431100000	B.26
G 20/4.00A/F	0431200000	B.20
G 20/4.00A/F	0431200000	B.26
G 20/4.00A/F	0431200000	A.22
G 20/4.00A/F	0431200000	A.28
G 20/4.00A/F	0431200000	B.21
G 20/5.00A/F	0431300000	B.20
G 20/5.00A/F	0431300000	B.26
G 20/5.00A/F	0431300000	A.23
G 20/5.00A/F	0431300000	A.22
G 20/5.00A/F	0431300000	A.28
G 25/0.25A/M GE	0546900000	B.26
G 25/0.25A/M GE	0546900000	A.28
G 25/0.50A/M WS	0510300000	A.28
G 25/0.50A/M WS	0510300000	B.26
G 25/0.80A/M GR	0646400000	A.28
G 25/0.80A/M GR	0646400000	B.26
G 25/1.00A/M RT	0265800000	B.26
G 25/1.00A/M RT	0265800000	A.28
G 25/10.0A/M RT	0193100000	B.26
G 25/10.0A/M RT	0193100000	A.28
G 25/2.00A/F BL	0192700000	A.28
G 25/2.00A/F BL	0192700000	B.26
G 25/4.00A/F BR	0192800000	A.28
G 25/4.00A/F BR	0192800000	B.26
G 25/6.30A/F GN	0192900000	A.28
G 25/6.30A/F GN	0192900000	B.26
GZ 0.5A/F	0533800000	A.28
GZ 0.5A/F	0533800000	B.26
GZ 1.0A/F	0525500000	B.26
GZ 1.0A/F	0525500000	A.28
GZ 1.0A/F	0525500000	A.23
GZ 10.0A	0293900000	B.26
GZ 10.0A	0293900000	A.28

Type	Order No.	Page
GZ 12.5A/FF	0245400000	B.26
GZ 12.5A/FF	0245400000	A.28
GZ 2.0A	0294500000	B.26
GZ 2.0A	0294500000	A.28
GZ 2.0A	0294500000	A.23
GZ 3.0A	0295700000	A.28
GZ 3.0A	0295700000	B.26
GZ 3.0A	0295700000	A.23
GZ 5.0A	0294600000	B.26
GZ 5.0A	0294600000	A.28
GZ 7.0A	0295800000	A.28
GZ 7.0A	0295800000	B.26

H

Type	Order No.	Page
H 0.5/16 S OR	9202900000	J.32
H 1,5/24 XS SW	9202870000	J.31
H 2,5/24 XS BL	9202880000	J.31
H 0,14/10 GR SV	9005180000	J.22
H 0,14/10T BR SV	9028250000	J.26
H 0,14/12 GR SV	9028240000	J.22
H 0,25/10 HBL	9025740000	J.22
H 0,25/10 HBL SV	9026050000	J.22
H 0,25/10T GE	9021010000	J.26
H 0,25/10T GE SV	9021210000	J.26
H 0,25/12 HBL	9025760000	J.22
H 0,25/12 HBL SV	9025780000	J.22
H 0,25/12T GE	9021020000	J.26
H 0,25/12T GE SV	9021220000	J.26
H 0,25/5	9018910000	J.33
H 0,34/10 TK	9025750000	J.22
H 0,34/10 TK SV	9026030000	J.22
H 0,34/12 TK	9025770000	J.22
H 0,34/12 TK BD GSP	9004390000	J.23
H 0,34/12 TK SV	9025790000	J.22
H 0,5/10	9004050000	J.33
H 0,5/10 OR SV	9028260000	J.22
H 0,5/12 OR	0409500000	J.22
H 0,5/12D W	9019000000	J.24
H 0,5/12D W	9019000000	J.26
H 0,5/14 OR	0690700000	J.22
H 0,5/14 OR BD	9004270000	J.23
H 0,5/14 OR BD GSP	9005810000	J.23
H 0,5/14 OR SV	9026060000	J.22
H 0,5/14D W	9019010000	J.26
H 0,5/14D W	9019010000	J.24
H 0,5/14D W BD	9004280000	J.24
H 0,5/14D W BD	9004280000	J.26
H 0,5/14D W BD GSP	9005860000	J.27
H 0,5/14D W BD GSP	9005860000	J.25
H 0,5/14D W SV	9019400000	J.24
H 0,5/14D W SV	9019400000	J.26
H 0,5/14S OR	9004560000	J.32
H 0,5/14S OR	9004590000	J.32
H 0,5/15 ZH OR	9037200000	J.30
H 0,5/15 ZH OR	9037200000	J.28
H 0,5/15 ZH OR SV	9004440000	J.28
H 0,5/15D ZH W	9037380000	J.29
H 0,5/15D ZH W SV	9004780000	J.29
H 0,5/16 DS Weiß	9202910000	J.32
H 0,5/16 OR	9025870000	J.22
H 0,5/16 OR	9025870000	J.14
H 0,5/16 OR SV	9028270000	J.22
H 0,5/16,5 ZH OR	9037210000	J.30
H 0,5/16,5 ZH OR	9037210000	J.28
H 0,5/16,5 ZH W	9037390000	J.29
H 0,5/16D ZH W	9019020000	J.26
H 0,5/16D W	9019020000	J.24
H 0,5/18,4D ZH W	9037400000	J.29
H 0,5/18,5 ZH OR	9037220000	J.28
H 0,5/18,5 ZH OR	9037220000	J.30
H 0,5/6	0282600000	J.33
H 0,75/10	0542500000	J.33
H 0,75/12 W	0409600000	J.22
H 0,75/12 W SV	9028280000	J.22
H 0,75/12D GR	9019030000	J.24
H 0,75/12T HBL	9021030000	J.26
H 0,75/14 GRAU BD GSP	9005870000	J.25
H 0,75/14 W	0462900000	J.22
H 0,75/14 W BD	9004290000	J.23
H 0,75/14 W BD GSP	9005820000	J.23
H 0,75/14 W SV	9026070000	J.22
H 0,75/14D GR	9019040000	J.24
H 0,75/14D GR BD	9004300000	J.24
H 0,75/14D GR SV	9019410000	J.24
H 0,75/14S W	9025960000	J.32
H 0,75/14S W SV	9025700000	J.32
H 0,75/14T BL BD GSP	9005900000	J.27
H 0,75/14T HBL BD	9004310000	J.26
H 0,75/14T HBL SV	9021230000	J.26
H 0,75/14T HBL	9018550000	J.32
H 0,75/15 ZH W	9037230000	J.28
H 0,75/15 ZH W SV	9018510000	J.28
H 0,75/15D ZH GR	9037410000	J.29
H 0,75/15D ZH GR SV	9018520000	J.29
H 0,75/15T ZH HBL		

Type	Order No.	Page	Type	Order No.	Page	Type	Order No.	Page	Type	Order No.	Page
H1,5/20D SW ZH SV	9004750000	J.30	H2,5/26,5D ZH BL	9037520000	J.29	IH 2.8 DB	0386060000	B.42	KSKM 3/35 GZ 1 1/4X1/4	9509620000	A.23
H1,5/20D SW ZH SV	9004750000	J.29	H2,5/26,5T ZH GR	9037660000	J.30	IH 2.8 DB	0386060000	E.9	KST 10	9501330000	B.55
H1,5/20D ZH SW	9037480000	J.29	H2,5/7	0373000000	J.33	IH 2.8 DB	0386060000	B.43	KST 10/35 M10X39	9506960000	A.49
H1,5/20D ZH SW	9037480000	J.30	H25,0/15	0124400000	J.33	IH 2.8 DB	0386060000	B.44	KST 10/35 M10X39	9528330000	A.49
H1,5/24 R	0565600000	J.22	H25,0/18	0375300000	J.33	IH 2.8 DB	0386060000	B.36	KST 12	9501340000	B.55
H1,5/24D SW	9019150000	J.24	H25,0/25	9004170000	J.33	IH 2.8 DB	0386060000	A.38	KST 12/35 M12X37	9506970000	A.49
H1,5/24D SW	9019150000	J.26	H25,0/30 BR	0317000000	J.22	IH 2.8 DB	0386060000	A.39	KST 12/35 M12X37	9528340000	A.49
H1,5/24D SW SV	9004140000	J.26	H25,0/30D 16 GE	9019280000	J.24	IH 6.3 WEM GE	0386260000	B.37	KST 5	9503370000	B.54
H1,5/24D SW SV	9004140000	J.24	H25,0/30T SW	9021190000	J.26	IH 6.3 WEM GE	0386260000	A.38	KST 5/35 M5X18	9528300000	A.48
H1,5/25,6 ZH R	9037310000	J.28	H25,0/32	9004180000	J.33	IH 6.3 WEM GE	0386260000	B.36	KST 6	9501310000	B.54
H1,5/25,6D ZH SW	9037490000	J.29	H25,0/36 BR	0317100000	J.22	IH 6.3 WEM GE	0386260000	E.9	KST 6/35 M6X22	9506940000	A.48
H1,5/25,6D ZH SW	9037490000	J.30	H25,0/36D GE	9019300000	J.24	IH 6.3 WEM GE	0386260000	B.43	KST 8	9501320000	B.55
H1,5/7	0372700000	J.33	H25,0/36T SW	9021200000	J.26	IH 6.3 WEM GE	0386260000	A.36	KST 8/35 M8X30	9506950000	A.49
H10,0/12	0282900000	J.33	H35,0/18	0368900000	J.33	IH 6.3 WEM GE	0386260000	A.39	KST 8/35 M8X30	9528320000	A.49
H10,0/15	0124800000	J.33	H35,0/25	9004190000	J.33	IH 6.3 WEM GE	0386260000	B.44	KT 12	9002660000	J.2
H10,0/18	0379300000	J.33	H35,0/30 BE	0317200000	J.22	IH 6.3 WEM GE	0386260000	E.8	KT 8	9002650000	J.2
H10,0/22 EB	0534200000	J.22	H35,0/30D 16 R	9019310000	J.24	IH 6.3 WEM GE	0386260000	A.37	KT ZQV	9002170000	J.3
H10,0/22D R	9019240000	J.24	H35,0/30D R	9019320000	J.24	IH 6.3 WEM GE	0386260000	B.42			
H10,0/22T BR	9021150000	J.26	H35,0/30S	9451000000	J.33	IK 16/ZB16 BL	0502980000	H.6			
H10,0/24,5X R SV	9006830000	J.31	H35,0/32	9004200000	J.33	IK 16/ZB16 GG	0502960000	H.6			
H10,0/24DS ZH R	9018880000	J.29	H35,0/39 BE	9031730000	J.22	IK 35/ZB35 BL	0502780000	H.6	LADEGERAET DMS 3	9007460000	J.10
H10,0/26 ZH EB	9037340000	J.28	H35,0/39D R	9019330000	J.24	IK 4 BL ZB4	0475480000	H.6			
H10,0/26 ZH EB SV	9004940000	J.28	H4,0/12	0244100000	J.33	IK 4 GG ZB4	0475460000	H.6			
H10,0/26D R ZH SV	9004710000	J.29	H4,0/15	9004100000	J.33	IK 6 BL ZBE6K	0526080000	H.6			
H10,0/26D ZH R	9037570000	J.29	H4,0/17D GR	9019190000	J.24	IK 6 GG ZBE6K	0526060000	H.6	Magazin SMark Laser	1782880000	K.21
H10,0/26T ZH BR	9037710000	J.30	H4,0/17D GR	9019190000	J.22	IS 2 KG	1806630000	J.20	MB M3/M5 CRM	0503500000	H.15
H10,0/26T ZH BR SV	9005170000	J.30	H4,0/17T OR	9021100000	J.26	IS 3 KG	1806650000	J.20	MB M5/M3 SW	0553400000	H.15
H10,0/28 EB	0565800000	J.22	H4,0/18	9004110000	J.33	IS 4 DIN 6911	0485100000	J.20	MB M6/M4 GR	0334900000	H.15
H10,0/28D R	9019250000	J.24	H4,0/19,5X GR SV	9006750000	J.31	IS 4 KG	1806660000	J.20	MC-Mobile 110V/220V	1741260001	K.25
H10,0/28T BR	9021160000	J.26	H4,0/20D GR	9019200000	J.22	IS 6 DIN 6911	0407900000	J.20	MC-MOBULO AUFN. SF 4-6	1802180000	K.25
H10,0/30 ZH EB	9037350000	J.28	H4,0/20D GR	9019200000	J.24	IS 8 DIN 6911	0235000000	J.20	MCP AP	1924360000	K.24
H10,0/30D ZH R	9037580000	J.29	H4,0/20T OR	9021110000	J.26	ISPF QB58 BL	0546080000	I.13	MCP AP LABLES	1924370000	K.24
H10,0/30T ZH BR	9037720000	J.30	H4,0/22D ZH GR	9037530000	J.29	ISPF QB58 RT	0546040000	I.13	MCP AP SFA-6	1924310000	K.24
H10,0/24S ZH EB	9018860000	J.28	H4,0/22D ZH GR	9037530000	J.28	ISPF QB58 SW	0546000000	I.13	MCP COVER	1924350000	K.24
H10,0/30DS ZH R	9018900000	J.29	H4,0/22T ZH OR	9037670000	J.30	ISPF QB75 BL	0526780000	I.13	MCP EP	1935130000	K.24
H10,0/30S ZH EB	9018870000	J.28	H4,0/22T ZH OR SV	9018590000	J.30	ISPF QB75 RT	0526760000	I.13	MCP KLEBESTREIFEN	1924320000	K.24
H120,0/32	9036240000	J.33	H4,0/26D GR	9019210000	J.24	ISPF QB75 SW	0526700000	I.13	MCP PLUS	1925000000	K.23
H120,0/50 BL	9028220000	J.22	H4,0/26D GR	9019210000	J.22				MEHA OB/UN 16" SPX 3	9054080000	J.4
H150,0/32	9036250000	J.33	H4,0/26T OR	9021120000	J.26				MEHA OB/UN 6" SPX 3	9054030000	J.4
H150,0/54 GE	9028230000	J.22	H4,0/28D ZH GR	9037540000	J.29				MF 2/12 1X2.8/1.6	0241760000	F.2
H16,0/12	0492500000	J.33	H4,0/28D ZH GR	9037540000	J.28	KDKS 1/32	9503300000	B.21	MK 10/14	0370160000	F.3
H16,0/15	0124300000	J.33	H4,0/28T ZH OR	9037680000	J.30	KDKS 1/35	9503310000	A.23	MK 2/12	0241260000	F.2
H16,0/18	0375200000	J.33	H4,0/9	0373100000	J.33	KDKS1/EN LD 115VAC	8142840000	C.7	MK 3/10	0274620000	F.2
H16,0/24 GN	0565900000	J.22	H4/17 GR SV	9026010000	J.22	KDKS1/EN LD 230VAC	8148910000	C.7	MK 3/10/E	7906190000	F.6
H16,0/24D BL	9019260000	J.24	H4/17 GR SV	9026010000	J.24	KDKS1/EN LD 24 VAC	8148930000	C.7	MK 3/11/E	7906200000	F.6
H16,0/24T W	9021170000	J.26	H4/17T OR SV	9021250000	J.26	KDKS1/EN LD 24VDC	8146450000	C.7	MK 3/12	0243520000	F.2
H16,0/25	9004150000	J.33	H4/22D ZH GR SV	9004730000	J.29	KDKS1/EN LD 48 VAC	8148920000	C.7	MK 3/12/E	7906210000	F.6
H16,0/25,5X BL SV	9006870000	J.31	H4/22D ZH GR SV	9004730000	J.28	KISC M2.5X11/4.5 AKZ1.5	0400100000	I.9	MK 3/2	0273820000	F.2
H16,0/28 GN	0566000000	J.22	H50,0/18	9004210000	J.33	KISC M3X15/6 SAK2.5	0359000000	I.9	MK 3/2/E	7906110000	F.6
H16,0/28D BL	9019270000	J.24	H50,0/25	9025890000	J.33	KISC M3X15/6 SAK2.5	0359000000	I.10	MK 3/3	0273920000	F.2
H16,0/28T W	9021180000	J.26	H50,0/32	9004220000	J.33	KISC M3X15/6 SAK2.5 CU5	0377200000	B.32	MK 3/3/E	7906120000	F.6
H16,0/29 ZH GN	9037360000	J.28	H50/36 OLIV	0444200000	J.22	KISC M3X15/6 SAK2.5 CU5	0377200000	I.12	MK 3/4	0274020000	F.2
H16,0/29D ZH BL	9037590000	J.29	H50/36D BL	9019340000	J.24	KISC M3X15/6 SAK2.5 CU5	0377200000	A.33	MK 3/4/E	7906130000	F.6
H16,0/29T ZH W	9037730000	J.30	H50/40D BL	9019350000	J.24	KISC M3X20 SAK10 CU5	0377100000	A.33	MK 3/5	0274120000	F.2
H16,0/32	9004160000	J.33	H6,0/20T GN	9021130000	J.26	KISC M3X20 SAK10 CU5	0377100000	I.12	MK 3/5/E	7906140000	F.6
H16,0/38 ZH GN	9037370000	J.28	H6,0/10	9004120000	J.33	KISC M3X20 SAK10 CU5	0377100000	A.32	MK 3/6	0274220000	F.2
H16,0/38D ZH BL	9037600000	J.29	H6,0/12	0191900000	J.33	KISC M3X20 SAK10 CU5	0377100000	B.31	MK 3/6/E	7906150000	F.6
H16,0/38T ZH W	9037740000	J.30	H6,0/15	0124700000	J.33	KISC M3X20 SAK10 CU5	0377100000	B.32	MK 3/7	0274320000	F.2
H185,0/32	9036260000	J.33	H6,0/18	9004130000	J.33	KISC M3X20 SAK10 CU5	0377100000	I.21	MK 3/7/E	7906160000	F.6
H2,5/10	9004080000	J.33	H6,0/20 SW	0535300000	J.22	KISC M3X20,5/10 EK4	0303000000	D.3	MK 3/8	0274420000	F.2
H2,5/12	0186100000	J.33	H6,0/20D GE	9019220000	J.24	KISC M3X20,5/10 EK4	0303000000	I.10	MK 3/8/E	7906170000	F.6
H2,5/12DS BL	9028490000	J.32	H6,0/23,0X GE SV	9006790000	J.31	KISC M3X20,5/10 EK4	0303000000	D.2	MK 3/9	0274520000	F.2
H2,5/12TS GR	9036200000	J.32	H6,0/25 ZH SW	9037320000	J.28	KISC M3X20,5/10 EK4	0303000000	B.28	MK 3/9/E	7906180000	F.6
H2,5/14 BL SV	9026100000	J.22	H6,0/25 ZH SW SV	9004930000	J.28	KISC M3X20,5/10 EK4	0303000000	I.9	MK 4/16	0244220000	F.3
H2,5/14 BL SV	9026100000	J.24	H6,0/25D ZH GE	9037550000	J.29	KISC M3X20,5/10 EK4	0303000000	A.11	MK 5/2 O.DE	0243820000	F.4
H2,5/14D BL	9019160000	J.22	H6,0/25T ZH GN	9037690000	J.30	KISC M3X6 SAKS1	0346200000	I.9	MK 6/2	0620420000	F.3
H2,5/14D BL	9019160000	J.24	H6,0/25T ZH GN SV	9005160000	J.30	KISC M5X50/26 SAK95	0630200000	B.9	MK 6/2/E	7906220000	F.7
H2,5/14D BL BD	9004360000	J.23	H6,0/26 SW	9015650000	J.22	KISC M5X50/26 SAK95	0630200000	A.10	MK 6/3	0620320000	F.3
H2,5/14D BL BD	9004360000	J.24	H6,0/26D GE	9019230000	J.24	KISC M5X50/26 SAK95	0630200000	I.9	MK 6/3/E	7906230000	F.7
H2,5/14D BL BD GSP	9005850000	J.23	H6,0/29 ZH SW	9037330000	J.28	KLBUE 10-20	1600490000	G.4	MK 6/4	0620220000	F.3
H2,5/14D BL BD GSP	9005850000	J.25	H6,0/29D ZH GE	9037660000	J.29	KLBUE 10-20 CPF	1752701001	G.11	MK 6/4/E	7906240000	F.7
H2,5/14S BL	1333100000	J.32	H6,0/29T ZH GN	9037700000	J.30	KLBUE 10-20 SC	1712321001	G.8	MK 6/5/E	7906250000	F.7
H2,5/14T GR	9021070000	J.26	H6/25D ZH GE SV	9004720000	J.29	KLBUE 15-32	1716300000	G.4	MK 6/6	0620120000	F.3
H2,5/14T GR BD	9004370000	J.26	H6/26T GN	9021140000	J.26	KLBUE 15-32 CPF	1752711001	G.11	MK 6/6/E	7906260000	F.7
H2,5/14T GR BD GSP	9005910000	J.27	H7,0/25	9004230000	J.33	KLBUE 15-32 SC	1718341001	G.8	MOFU 35	0495660000	H.15
H2,5/14T GR SV	9021240000	J.26	H7,0/32	9004240000	J.33	KLBUE 3-8	1600480000	G.4	MOFU 35/LO/1	0646260000	H.15
H2,5/14TS GR	9426770000	J.32	H7,0/40 GE	9028200000	J.22	KLBUE 3-8 CPF SS	1752681001	G.11	M-PRINT PRO	1905490000	K.26
H2,5/16DS BL	9036220000	J.32	H95,0/25	9004250000	J.33	KLBUE 3-8 SC	1692261001	G.8	M-PRINT PRO	1905490000	K.24
H2,5/17,5X BL SV	9006670000	J.31	H95,0/32	9004260000	J.33	KLBUE 4-13.5	1592810000	G.4	M-PRINT PRO ADVANCED	1905500000	K.26
H2,5/18	9004090000	J.33	H95,0/44 R	9028210000	J.22	KLBUE 4-13.5 CPF	1752691001	G.11			
H2,5/18,5D ZH BL	9037500000	J.28	HP 1 ADP1	0485560000	I.16	KLBUE 4-13.5 SC	1712311001	G.8			
H2,5/18,5D ZH BL	9037500000	J.29	HP 2 ADP2	0485660000	I.16	KLBUE CO 1	1753311001	G.5			
H2,5/18,5D ZH BL SV	9004430000	J.28	HP 3 ADP3	0485760000	I.16	KLBUE CO 2	1752131001	G.5	NSCH 1M	0280200000	H.3
H2,5/18,5D ZH BL SV	9004430000	J.29	HP 4 ADP3	0485860000	I.16	KLBUE CO 3	1749151001	G.5	NT 10/35		

Type	Order No.	Page	Type	Order No.	Page	Type	Order No.	Page	Type	Order No.	Page
P 14/4 D01 BR SAKS4	0138100000	A.26	PS 2.3 RT	0180400000	E.11	Q 10 SAK10	0457400000	A.8	Q 2 SAK4	0336700000	A.37
P 14/4 D01 BR SAKS4	0138100000	B.27	PS 2.3 RT	0180400000	B.59	Q 10 SAK10	0457400000	B.3	Q 2 SAK4	0336700000	B.3
P 14/6 D01 GN SAKS4	0328600000	B.27	PS 2.3 RT	0180400000	B.6	Q 10 SAK10	0457400000	B.7	Q 2 SAK4	0336700000	C.5
P 14/6 D01 GN SAKS4	0328600000	A.26	PS 2.3 RT	0180400000	A.40	Q 10 SAK16	0457800000	A.9	Q 2 SAK4	0336700000	1.9
P 14/6 D01 GN SAKS4	0328600000	B.24	PS 2.3 RT	0180400000	B.18	Q 10 SAK16	0457800000	1.9	Q 2 SAK4	0336700000	B.36
P 14/6 D01 GN SAKS4	0328600000	A.29	PS 2.3 RT	0180400000	A.39	Q 10 SAK16	0457800000	C.3	Q 2 SAK4	0336700000	A.36
P 16/10 RT SAKS2	0208900000	B.24	PS 2.3 RT	0180400000	B.58	Q 10 SAK16	0457800000	A.4	Q 2 SAK4	0336700000	A.3
P 16/10 RT SAKS2	0208900000	B.27	PS 2.3 RT	0180400000	B.60	Q 10 SAK16	0457800000	B.4	Q 2 SAK4	0336700000	D.6
P 16/10 RT SAKS2	0208900000	A.29	PS 2.3 RT	0180400000	A.36	Q 10 SAK16	0457800000	B.7	Q 2 SAK4	0336700000	A.7
P 16/10 RT SAKS2	0208900000	A.26	PS 2.3 RT	0180400000	A.37	Q 10 SAK2.5	0368700000	1.9	Q 2 SAK4	0336700000	B.6
P 16/16 GR SAKS2	0209000000	A.26	PS 2.3 RT	0180400000	B.39	Q 10 SAK2.5	0368700000	A.2	Q 2 SAK4	0336700000	B.42
P 16/16 GR SAKS2	0209000000	A.29	PS 2.3 RT	0180400000	B.38	Q 10 SAK2.5	0368700000	A.7	Q 2 SAK4	0336700000	B.43
P 16/16 GR SAKS2	0209000000	B.24	PS 2.3 RT	0180400000	B.37	Q 10 SAK2.5	0368700000	B.2	Q 2 SAK6N	0456700000	1.21
P 16/16 GR SAKS2	0209000000	B.27	PS 2.3 RT	0180400000	A.20	Q 10 SAK2.5	0368700000	B.45	Q 2 SAK6N	0456700000	1.9
P 16/20 BL SAKS2	0209100000	B.27	PS 2.3 RT	0180400000	B.36	Q 10 SAK2.5	0368700000	B.38	Q 2 SAK6N	0456700000	A.8
P 16/20 BL SAKS2	0209100000	B.24	PS 2.3 RT	0180400000	B.61	Q 10 SAK2.5	0368700000	B.39	Q 2 SAK6N	0456700000	B.3
P 16/20 BL SAKS2	0209100000	A.26	PS 2.3 RT	0180400000	A.12	Q 10 SAK2.5	0368700000	B.6	Q 2 SAK6N	0456700000	C.3
P 16/20 BL SAKS2	0209100000	A.29	PS 2.3 RT	0180400000	B.32	Q 10 SAK2.5	0368700000	A.40	Q 2 SAK6N	0456700000	A.3
P 18/20 D02 BL SAKS5	0361800000	A.29	PS 2.3 RT	0180400000	C.2	Q 10 SAK2.5	0368700000	C.2	Q 2 SAK6N	0456700000	B.7
P 18/20 D02 BL SAKS5	0361800000	B.25	PS 2.3 RT	0180400000	B.16	Q 10 SAK4	0368800000	B.3	Q 2 SAKD2.5N	0367800000	B.2
P 18/20 D02 BL SAKS5	0361800000	A.27	PS 2.3 RT	0180400000	B.10	Q 10 SAK4	0368800000	B.6	Q 2 SAKD2.5N	0367800000	A.2
P 18/20 D02 BL SAKS5	0361800000	B.27	PS 2.3 RT	0180400000	B.17	Q 10 SAK4	0368800000	B.36	Q 3 AKZ1.5	0368300000	1.11
P 18/25 D02 GE SAKS5	0361900000	B.25	PS 2.3 RT	0180400000	A.7	Q 10 SAK4	0368800000	C.2	Q 3 AKZ1.5	0368300000	E.10
P 18/25 D02 GE SAKS5	0361900000	B.27	PS 2.3 RT	0180400000	E.13	Q 10 SAK4	0368800000	A.3	Q 3 AKZ1.5	0368300000	E.2
P 18/25 D02 GE SAKS5	0361900000	A.29	PS 2.3 RT	0180400000	C.5	Q 10 SAK4	0368800000	B.42	Q 3 AKZ4	0336500000	A.50
P 18/25 D02 GE SAKS5	0361900000	A.27	PS 2.3 RT	0180400000	B.11	Q 10 SAK4	0368800000	C.5	Q 3 AKZ4	0336500000	B.10
P 18/35 D02 SW SAKS5	0362000000	B.27	PS 2.3 RT	0180400000	E.10	Q 10 SAK4	0368800000	B.43	Q 3 AKZ4	0336500000	B.60
P 18/35 D02 SW SAKS5	0362000000	B.25	PS 2.3 RT	0180400000	C.4	Q 10 SAK4	0368800000	1.9	Q 3 AKZ4	0336500000	B.61
P 18/35 D02 SW SAKS5	0362000000	A.29	PS 2.3 RT	0180400000	E.12	Q 10 SAK4	0368800000	D.6	Q 3 AKZ4	0336500000	E.10
P 18/35 D02 SW SAKS5	0362000000	A.27	PS 4 FSTB 4	0299600000	A.5	Q 10 SAK4	0368800000	A.36	Q 3 AKZ4	0336500000	A.51
P 18/50 D02 WS SAKS5	0362100000	B.27	PS 4 FSTB 4	0299600000	B.7	Q 10 SAK4	0368800000	A.37	Q 3 AKZ4	0336500000	E.9
P 18/50 D02 WS SAKS5	0362100000	B.25	PS 4 FSTB 4	0299600000	A.6	Q 10 SAK4	0368800000	C.4	Q 3 AKZ4	0336500000	A.13
P 18/50 D02 WS SAKS5	0362100000	A.29	PS 4 FSTB 4	0299600000	A.3	Q 10 SAK4	0368800000	A.7	Q 3 AKZ4	0336500000	B.58
P 18/50 D02 WS SAKS5	0362100000	A.27	PS 4 FSTB 4	0299600000	D.9	Q 10 SAK6N	0457000000	1.21	Q 3 AKZ4	0336500000	E.3
P-CLEANER	1924330000	K.25	PS 4 FSTB 4	0299600000	A.4	Q 10 SAK6N	0457000000	B.3	Q 3 AKZ4	0336500000	A.52
P-CLEANER	1924330000	K.24	PS 4 FSTB 4	0299600000	B.4	Q 10 SAK6N	0457000000	C.3	Q 3 AKZ4	0336500000	E.13
P-INK	1924340000	K.24	PS 4 FSTB 4	0299600000	A.20	Q 10 SAK6N	0457000000	A.3	Q 3 AKZ4	0336500000	B.59
P-INK	1924340000	K.25	PS 4 FSTB 4	0299600000	A.33	Q 10 SAK6N	0457000000	B.7	Q 3 AKZ4	0336500000	B.38
PJ PRO TINTK FL	1027080000	K.22	PS 4 FSTB 4	0299600000	B.5	Q 10 SAK6N	0457000000	1.9	Q 3 AKZ4	0336500000	A.12
PJ PRO TINTK INK C	1027050000	K.22	PS 4 FSTB 4	0299600000	C.3	Q 10 SAK6N	0457000000	A.8	Q 3 AKZ4	0336500000	E.12
PJ PRO TINTK INK K	1027040000	K.22	PS 4 FSTB 4	0299600000	B.19	Q 10 SAKD2.5N	0368100000	B.2	Q 3 AKZ4	0336500000	1.9
PJ PRO TINTK INK M	1027060000	K.22	PS 4 FSTB 4	0299600000	B.30	Q 10 SAKD2.5N	0368100000	A.2	Q 3 AKZ4	0336500000	A.39
PJ PRO TINTK INK SET BK	1027090000	K.22	PS 4 FSTB 4	0299600000	B.3	Q 2 AKZ1.5	0368200000	1.11	Q 3 AKZ4	0336500000	A.54
PJ PRO TINTK INK Y	1027070000	K.22	PS 4 FSTB 4	0299600000	1.14	Q 2 AKZ1.5	0368200000	E.2	Q 3 AKZ4	0336500000	B.11
PJ-Clean Unit	4062150000	K.22	PS 4 FSTB 4	0299600000	A.9	Q 2 AKZ1.5	0368200000	E.10	Q 3 AKZ4	0336500000	B.37
PJ-PRO TINTK INK SET COL	1027110000	K.22	PS 4 FSTB 4	0299600000	B.8	Q 2 AKZ4	0336400000	E.10	Q 3 AKZ4	0336500000	A.56
PLOTTER PEN 0.25 P-INK	1920640000	K.25	PS 4 FSTB 4	0299600000	B.31	Q 2 AKZ4	0336400000	A.39	Q 3 AKZ4	0336500000	A.38
PLOTTER PEN 0.25 P-INK	1920640000	K.24	PS 4 FSTB 4	0299600000	B.9	Q 2 AKZ4	0336400000	B.61	Q 3 AKZ4	0336500000	A.53
PLOTTER PEN 0.35 P-INK	1920650000	K.24	PS 4 FSTB 4	0299600000	B.32	Q 2 AKZ4	0336400000	A.55	Q 3 AKZ4	0336500000	B.57
PLOTTER PEN 0.35 P-INK	1920650000	K.25	PS 4 FSTB 4	0299600000	A.10	Q 2 AKZ4	0336400000	A.56	Q 3 AKZ4	0336500000	A.55
PLOTTER PEN 0.50 P-INK	1005710000	K.25	PS 4 FSTB 4	0299600000	D.6	Q 2 AKZ4	0336400000	B.37	Q 3 AKZ4	0336500000	E.11
PLOTTER PEN 0.50 P-INK	1005710000	K.24	PS 4 FSTB 4	0299600000	B.29	Q 2 AKZ4	0336400000	B.57	Q 3 AKZ4	0336500000	1.11
PLOTTER PEN 0.70 P-INK	1011450000	K.24	PS 4 FSTB 4	0299600000	B.28	Q 2 AKZ4	0336400000	E.11	Q 3 AKZ4	0336500000	B.56
PLOTTER PEN 0.70 P-INK	1011450000	K.25	PS 4 FSTB 4	0299600000	C.4	Q 2 AKZ4	0336400000	B.38	Q 3 AKZ4SS	0369100000	1.11
Plotterpen 0,18	1768570000	K.25	PS 4 FSTB 4	0299600000	A.32	Q 2 AKZ4	0336400000	E.13	Q 3 AKZ4SS	0369100000	E.8
Plotterpen 0,18	1768570000	K.24	PS 4 FSTB 4	0299600000	A.8	Q 2 AKZ4	0336400000	A.12	Q 3 DLJ	1312600000	1.11
Plotterpen 0,25	1768540000	K.25	PZ 1.5	9005990000	J.35	Q 2 AKZ4	0336400000	B.60	Q 3 SAK10	0457200000	C.3
Plotterpen 0,25	1768540000	K.24	PZ 16	9012600000	J.8	Q 2 AKZ4	0336400000	B.10	Q 3 SAK10	0457200000	B.7
Plotterpen 0,35	1768550000	K.25	PZ 16	9012600000	J.35	Q 2 AKZ4	0336400000	B.11	Q 3 SAK10	0457200000	A.8
Plotterpen 0,35	1768550000	K.24	PZ 3	0567300000	J.7	Q 2 AKZ4	0336400000	E.12	Q 3 SAK10	0457200000	A.3
Plotterpen 0,5	1768560000	K.25	PZ 3	0567300000	J.35	Q 2 AKZ4	0336400000	E.9	Q 3 SAK10	0457200000	B.3
Plotterpen 0,5	1768560000	K.24	PZ 4	9012500000	J.35	Q 2 AKZ4	0336400000	E.3	Q 3 SAK10	0457200000	1.9
PLOTTERPEN 0,7	1011440000	K.25	PZ 4	9012500000	J.6	Q 2 AKZ4	0336400000	A.38	Q 3 SAK16	0457600000	B.4
PLOTTERPEN 0,7	1011440000	K.24	PZ 50	9006450000	J.35	Q 2 AKZ4	0336400000	A.50	Q 3 SAK16	0457600000	A.9
POSC M3X20 PA/NA	0451300000	1.17	PZ 50	9006450000	J.9	Q 2 AKZ4	0336400000	B.56	Q 3 SAK16	0457600000	C.3
PFFT/35	3835020000	D.9	PZ 6 HEX	9013650000	J.35	Q 2 AKZ4	0336400000	1.11	Q 3 SAK16	0457600000	B.7
PRINT KIT	1686920000	K.25	PZ 6 Roto	9014350000	J.35	Q 2 AKZ4	0336400000	A.51	Q 3 SAK16	0457600000	1.9
PRINTJET PFO 115V	1024050000	K.22	PZ 6 Roto	9014350000	J.7	Q 2 AKZ4	0336400000	A.53	Q 3 SAK16	0457600000	A.4
PRINTJET PRO 230V	1001180001	K.22	PZ 6/5	9011460000	J.35	Q 2 AKZ4	0336400000	A.52	Q 3 SAK2.5	0337100000	B.6
PS 2.0 MC	0310000000	1.14	PZ 6/5	9011460000	J.6	Q 2 AKZ4	0336400000	A.13	Q 3 SAK2.5	0337100000	B.38
PS 2.0 OR	0293800000	1.14	PZ ZH 16	9013600000	J.8	Q 2 AKZ4	0336400000	1.9	Q 3 SAK2.5	0337100000	A.2
PS 2.0 OR	0293800000	A.33	PZ ZH 16	9013600000	J.35	Q 2 AKZ4	0336400000	B.58	Q 3 SAK2.5	0337100000	C.2
PS 2.3 RT	0180400000	E.3				Q 2 AKZ4	0336400000	B.59	Q 3 SAK2.5	0337100000	B.39
PS 2.3 RT	0180400000	A.2	Q			Q 2 AKZ4	0336400000	A.54	Q 3 SAK2.5	0337100000	B.45
PS 2.3 RT	0180400000	E.9				Q 2 AKZ4SS	0369000000	1.11	Q 3 SAK2.5	0337100000	A.7
PS 2.3 RT	0180400000	E.8	Q 10 AKZ1.5	0368500000	E.2	Q 2 AKZ4SS	0369000000	E.8	Q 3 SAK2.5	0337100000	B.2
PS 2.3 RT	0180400000	A.54	Q 10 AKZ1.5	0368500000	1.11	Q 2 DLJ	1312500000	1.11	Q 3 SAK2.5	0337100000	A.40
PS 2.3 RT	0180400000	B.28	Q 10 AKZ1.5	0368500000	E.10	Q 2 SAK10	0457100000	A.8	Q 3 SAK4	0336800000	A.3
PS 2.3 RT	0180400000	A.19	Q 10 AKZ4	0368600000	E.3	Q 2 SAK10	0457100000	B.7	Q 3 SAK4	0336800000	A.37
PS 2.3 RT	0180400000	1.14	Q 10 AKZ4	0368600000	E.9	Q 2 SAK10	0457100000	B.3	Q 3 SAK4	0336800000	B.36
PS 2.3 RT	0180400000	A.50	Q 10 AKZ4	0368600000	B.38	Q 2 SAK10	0457100000	C.3	Q 3 SAK4	0336800000	C.4
PS 2.3 RT	0180400000	A.51	Q 10 AKZ4	0368600000	E.12	Q 2 SAK10	0457100000	A.3	Q 3 SAK4	0336800000	1.9
PS 2.3 RT	0180400000	A.52	Q 10 AKZ4	0368600000	A.56	Q 2 SAK10	0457100000	1.9	Q 3 SAK4	0336800000	B.6
PS 2.3 RT	0180400000	A.53	Q 10 AKZ4	0368600000	E.11	Q 2 SAK16	0457500000	B.4	Q 3 SAK4	0336800000	C.5
PS 2.3 RT	0180400000	A.11	Q 10 AKZ4	0368600000	E.13	Q 2 SAK16	0457500000	C.3	Q 3 SAK4	0336800000	D.6
PS 2.3 RT											

Type	Order No.	Page	Type	Order No.	Page	Type	Order No.	Page	Type	Order No.	Page
Q 4 AKZ1.5	0368400000	E.10	QB 2 WI RA6 IS	0482700000	A.50	QL 10 SAKS1	0338800000	A.24	QL 2 SAKS4	0328000000	I.9
Q 4 AKZ1.5	0368400000	I.11	QB 2 WI RA8 IS	0461100000	E.6	QL 10 SAKS2	0338900000	A.26	QL 2 SAKS4	0328000000	B.24
Q 4 AKZ1.5	0368400000	E.2	QB 2 WI RA8 IS	0461100000	C.7	QL 10 SAKS2	0338900000	A.27	QL 2 SAKS4	0328000000	A.27
Q 4 AKZ4	0336600000	B.58	QB 2 WI RA8 IS	0461100000	B.21	QL 10 SAKS2	0338900000	I.9	QL 2 SAKS4	0328000000	A.26
Q 4 AKZ4	0336600000	A.55	QB 3 SAKT1	0205800000	I.21	QL 10 SAKS2	0338900000	B.25	QL 3 DLI	0297300000	I.9
Q 4 AKZ4	0336600000	A.54	QB 3 WI RA6 IS	0482800000	A.19	QL 10 SAKS2	0338900000	B.24	QL 3 RSF1+2	0267500000	B.28
Q 4 AKZ4	0336600000	A.12	QB 3 WI RA6 IS	0482800000	B.57	QL 10 SAKS4	0339000000	A.27	QL 3 RSF1+2	0267500000	B.29
Q 4 AKZ4	0336600000	B.61	QB 3 WI RA6 IS	0482800000	B.61	QL 10 SAKS4	0339000000	I.9	QL 3 SAK10	0470400000	I.9
Q 4 AKZ4	0336600000	A.53	QB 3 WI RA6 IS	0482800000	B.39	QL 10 SAKS4	0339000000	B.24	QL 3 SAK16	0470800000	I.9
Q 4 AKZ4	0336600000	A.39	QB 3 WI RA6 IS	0482800000	B.60	QL 10 SAKS4	0339000000	B.25	QL 3 SAK2.5	0156000000	B.32
Q 4 AKZ4	0336600000	B.59	QB 3 WI RA6 IS	0482800000	B.56	QL 10 SAKS4	0339000000	A.26	QL 3 SAK2.5	0156000000	I.10
Q 4 AKZ4	0336600000	B.60	QB 3 WI RA6 IS	0482800000	B.16	QL 15 SAKGN	0221200000	I.21	QL 3 SAK2.5	0156000000	I.9
Q 4 AKZ4	0336600000	A.56	QB 3 WI RA6 IS	0482800000	B.38	QL 2 DLI	0297200000	I.9	QL 3 SAK2.5	0156000000	A.33
Q 4 AKZ4	0336600000	B.57	QB 3 WI RA6 IS	0482800000	B.17	QL 2 KST10	9501370000	B.55	QL 3 SAK35	0123700000	C.4
Q 4 AKZ4	0336600000	E.3	QB 3 WI RA6 IS	0482800000	A.55	QL 2 KST10	9501370000	A.49	QL 3 SAK35	0123700000	B.8
Q 4 AKZ4	0336600000	A.50	QB 3 WI RA6 IS	0482800000	A.20	QL 2 KST12	9501380000	A.49	QL 3 SAK35	0123700000	B.4
Q 4 AKZ4	0336600000	A.38	QB 3 WI RA6 IS	0482800000	B.40	QL 2 KST12	9501380000	B.55	QL 3 SAK35	0123700000	A.4
Q 4 AKZ4	0336600000	A.51	QB 3 WI RA6 IS	0482800000	B.59	QL 2 KST6	9501350000	B.54	QL 3 SAK35	0123700000	A.5
Q 4 AKZ4	0336600000	E.9	QB 3 WI RA6 IS	0482800000	A.50	QL 2 KST6	9501350000	A.48	QL 3 SAK35	0123700000	I.9
Q 4 AKZ4	0336600000	B.11	QB 3 WI RA6 IS	0482800000	A.18	QL 2 KST8	9501360000	B.55	QL 3 SAK35	0123700000	B.5
Q 4 AKZ4	0336600000	I.11	QB 3 WI RA6 IS	0482800000	A.56	QL 2 KST8	9501360000	A.49	QL 3 SAK35N	0565000000	B.9
Q 4 AKZ4	0336600000	A.52	QB 3 WI RA6 IS	0482800000	B.58	QL 2 RSF1+2	0267400000	B.29	QL 3 SAK35N	0565000000	A.5
Q 4 AKZ4	0336600000	A.13	QB 3 WI RA6 IS	0482800000	A.54	QL 2 RSF1+2	0267400000	B.28	QL 3 SAK35N	0565000000	I.9
Q 4 AKZ4	0336600000	B.37	QB 3 WI RA6 IS	0482800000	A.53	QL 2 SAK10	0470300000	I.10	QL 3 SAK35N	0565000000	B.5
Q 4 AKZ4	0336600000	E.12	QB 3 WI RA6 IS	0482800000	A.52	QL 2 SAK10	0470300000	I.9	QL 3 SAK35N	0565000000	A.9
Q 4 AKZ4	0336600000	B.10	QB 3 WI RA6 IS	0482800000	A.51	QL 2 SAK16	0470700000	I.9	QL 3 SAK4	0130700000	A.37
Q 4 AKZ4	0336600000	E.38	QB 3 WI RA8 IS	0461200000	E.6	QL 2 SAK2.5	0155900000	A.33	QL 3 SAK4	0130700000	I.9
Q 4 AKZ4	0336600000	E.13	QB 3 WI RA8 IS	0461200000	C.7	QL 2 SAK2.5	0155900000	I.9	QL 3 SAK4	0130700000	A.38
Q 4 AKZ4	0336600000	E.11	QB 3 WI RA8 IS	0461200000	B.21	QL 2 SAK2.5	0155900000	B.32	QL 3 SAK4	0130700000	B.44
Q 4 AKZ4	0336600000	E.10	QB 4 SAKT1	0205900000	I.21	QL 2 SAK2.5	0155900000	I.10	QL 3 SAK4	0130700000	B.37
Q 4 AKZ4	0336600000	B.56	QB 4 WI RA6 IS	0482900000	A.53	QL 2 SAK35	0123600000	B.8	QL 3 SAK6N	0194400000	I.10
Q 4 AKZ4SS	0369200000	I.11	QB 4 WI RA6 IS	0482900000	B.56	QL 2 SAK35	0123600000	I.9	QL 3 SAK6N	0194400000	B.28
Q 4 AKZ4SS	0369200000	E.8	QB 4 WI RA6 IS	0482900000	A.54	QL 2 SAK35	0123600000	C.4	QL 3 SAK6N	0194400000	A.32
Q 4 DLI	1312700000	I.11	QB 4 WI RA6 IS	0482900000	B.61	QL 2 SAK35	0123600000	B.5	QL 3 SAK6N	0194400000	I.21
Q 4 SAK10	0457300000	C.3	QB 4 WI RA6 IS	0482900000	B.58	QL 2 SAK35	0123600000	B.4	QL 3 SAK6N	0194400000	A.33
Q 4 SAK10	0457300000	B.7	QB 4 WI RA6 IS	0482900000	A.55	QL 2 SAK35	0123600000	A.4	QL 3 SAK6N	0194400000	B.32
Q 4 SAK10	0457300000	A.3	QB 4 WI RA6 IS	0482900000	B.59	QL 2 SAK35	0123600000	A.5	QL 3 SAK6N	0194400000	A.11
Q 4 SAK10	0457300000	I.9	QB 4 WI RA6 IS	0482900000	B.57	QL 2 SAK35N	0564900000	I.9	QL 3 SAK6N	0194400000	I.9
Q 4 SAK10	0457300000	B.3	QB 4 WI RA6 IS	0482900000	A.52	QL 2 SAK35N	0564900000	A.9	QL 3 SAK6N	0194400000	B.31
Q 4 SAK10	0457300000	A.8	QB 4 WI RA6 IS	0482900000	B.60	QL 2 SAK35N	0564900000	B.5	QL 3 SAK70	0167000000	I.9
Q 4 SAK16	0457700000	B.4	QB 4 WI RA6 IS	0482900000	A.50	QL 2 SAK35N	0564900000	B.9	QL 3 SAK70	0167000000	B.9
Q 4 SAK16	0457700000	I.9	QB 4 WI RA6 IS	0482900000	B.16	QL 2 SAK35N	0564900000	A.5	QL 3 SAK70	0167000000	A.6
Q 4 SAK16	0457700000	A.4	QB 4 WI RA6 IS	0482900000	B.40	QL 2 SAK4	0130600000	A.38	QL 3 SAKA10	0135600000	B.19
Q 4 SAK16	0457700000	C.3	QB 4 WI RA6 IS	0482900000	A.18	QL 2 SAK4	0130600000	B.44	QL 3 SAKA10	0135600000	A.20
Q 4 SAK16	0457700000	A.9	QB 4 WI RA6 IS	0482900000	A.51	QL 2 SAK4	0130600000	B.37	QL 3 SAKA10	0135600000	B.30
Q 4 SAK16	0457700000	B.7	QB 4 WI RA6 IS	0482900000	B.39	QL 2 SAK4	0130600000	A.37	QL 3 SAKB10	0114300000	B.30
Q 4 SAK2.5	0337200000	A.40	QB 4 WI RA6 IS	0482900000	B.38	QL 2 SAK4	0130600000	I.10	QL 3 SAKG28	0407600000	B.46
Q 4 SAK2.5	0337200000	A.2	QB 4 WI RA6 IS	0482900000	A.19	QL 2 SAK4	0130600000	I.9	QL 3 SAKG28	0407600000	I.9
Q 4 SAK2.5	0337200000	B.6	QB 4 WI RA6 IS	0482900000	B.17	QL 2 SAK6N	0194300000	A.32	QL 3 SAKG28	0407600000	B.47
Q 4 SAK2.5	0337200000	B.45	QB 4 WI RA6 IS	0482900000	A.56	QL 2 SAK6N	0194300000	I.9	QL 3 SAKG28	0407600000	A.10
Q 4 SAK2.5	0337200000	A.7	QB 4 WI RA6 IS	0482900000	A.20	QL 2 SAK6N	0194300000	I.10	QL 3 SAKG28	0407600000	B.9
Q 4 SAK2.5	0337200000	B.39	QB 4 WI RA8 IS	0461300000	E.6	QL 2 SAK6N	0194300000	A.11	QL 3 SAKG32+70	0441500000	A.43
Q 4 SAK2.5	0337200000	B.38	QB 4 WI RA8 IS	0461300000	C.7	QL 2 SAK6N	0194300000	A.33	QL 3 SAKG32+70	0441500000	A.42
Q 4 SAK2.5	0337200000	B.2	QB 4 WI RA8 IS	0461300000	B.21	QL 2 SAK6N	0194300000	B.32	QL 3 SAKG32+70	0441500000	A.44
Q 4 SAK2.5	0337200000	C.2	QL 10 RSF1+2	0341700000	B.29	QL 2 SAK6N	0194300000	B.28	QL 3 SAKG32+70	0441500000	B.48
Q 4 SAK4	0336900000	A.37	QL 10 RSF1+2	0341700000	B.28	QL 2 SAK6N	0194300000	I.21	QL 3 SAKG32+70	0441500000	B.49
Q 4 SAK4	0336900000	B.3	QL 10 SAK10	0470600000	I.9	QL 2 SAK6N	0194300000	B.31	QL 3 SAKG32+70	0441500000	B.50
Q 4 SAK4	0336900000	A.36	QL 10 SAK16	0471000000	I.9	QL 2 SAK6N-SAK35	0207400000	I.10	QL 3 SAKG40	0263500000	B.50
Q 4 SAK4	0336900000	C.4	QL 10 SAK2.5	0338100000	I.9	QL 2 SAK70	0345300000	A.6	QL 3 SAKG40	0263500000	B.51
Q 4 SAK4	0336900000	B.43	QL 10 SAK2.5	0338100000	A.33	QL 2 SAK70	0345300000	B.9	QL 3 SAKG40/35	0444900000	A.45
Q 4 SAK4	0336900000	C.2	QL 10 SAK2.5	0338100000	B.32	QL 2 SAK70	0345300000	I.9	QL 3 SAKG46	0444400000	A.46
Q 4 SAK4	0336900000	C.5	QL 10 SAK2.5	0338100000	I.10	QL 2 SAKA10	0135500000	I.10	QL 3 SAKG46	0444400000	B.52
Q 4 SAK4	0336900000	B.36	QL 10 SAK35	0338600000	C.4	QL 2 SAKA10	0135500000	B.19	QL 3 SAKG46	0444400000	A.47
Q 4 SAK4	0336900000	I.9	QL 10 SAK35	0338600000	B.8	QL 2 SAKA10	0135500000	A.20	QL 3 SAKG54	0408000000	B.53
Q 4 SAK4	0336900000	B.42	QL 10 SAK35	0338600000	A.5	QL 2 SAKA10	0135500000	B.30	QL 3 SAKG54	0408000000	A.47
Q 4 SAK4	0336900000	B.6	QL 10 SAK35	0338600000	A.4	QL 2 SAKB10	0114100000	B.30	QL 3 SAKK 10	9502660000	D.3
Q 4 SAK4	0336900000	A.7	QL 10 SAK35	0338600000	I.11	QL 2 SAKG28	0551200000	I.9	QL 3 SAKK 10 TIN	9509480000	D.3
Q 4 SAK4	0336900000	D.6	QL 10 SAK35	0338600000	I.9	QL 2 SAKG28	0551200000	A.10	QL 3 SAKK 4	9502550000	D.2
Q 4 SAK4	0336900000	A.3	QL 10 SAK35	0338600000	B.4	QL 2 SAKG28	0551200000	B.47	QL 3 SAKK 4 TIN	9509430000	D.2
Q 4 SAK6N	0456900000	A.8	QL 10 SAK35N	0338600000	B.5	QL 2 SAKG28	0551200000	B.9	QL 3 SAKS1	0191500000	A.24
Q 4 SAK6N	0456900000	I.21	QL 10 SAK35N	0565200000	B.9	QL 2 SAKG28	0551200000	B.46	QL 3 SAKS1	0191500000	B.22
Q 4 SAK6N	0456900000	A.3	QL 10 SAK35N	0565200000	A.5	QL 2 SAKG32+70	0194000000	A.44	QL 3 SAKS1	0191500000	I.9
Q 4 SAK6N	0456900000	B.3	QL 10 SAK35N	0565200000	B.5	QL 2 SAKG32+70	0194000000	B.48	QL 3 SAKS1	0191500000	B.23
Q 4 SAK6N	0456900000	B.7	QL 10 SAK35N	0565200000	A.9	QL 2 SAKG32+70	0194000000	B.49	QL 3 SAKS1	0191500000	A.25
Q 4 SAK6N	0456900000	C.3	QL 10 SAK35N	0565200000	I.9	QL 2 SAKG32+70	0194000000	B.50	QL 3 SAKS2	0207900000	A.26
Q 4 SAK6N	0456900000	I.9	QL 10 SAK4	0338200000	B.37	QL 2 SAKG32+70	0194000000	A.43	QL 3 SAKS2	0207900000	B.24
Q 4 SAKD2.5N	0368000000	A.2	QL 10 SAK4	0338200000	A.38	QL 2 SAKG32+70	0194000000	A.42	QL 3 SAKS2	0207900000	A.27
Q 4 SAKD2.5N	0368000000	B.2	QL 10 SAK4	0338200000	A.37	QL 2 SAKG40	0194100000	B.50	QL 3 SAKS2	0207900000	B.25
QB 10 SAKT1	0343800000	I.21	QL 10 SAK4	0338200000	I.10	QL 2 SAKG40	0194100000	B.51	QL 3 SAKS2	0207900000	I.9
QB 2 SAKT1	0205700000	I.21	QL 10 SAK4	0338200000	I.9	QL 2 SAKG40/35	0211400000	A.45	QL 3 SAKS4	0328100000	B.25
QB 2 WI RA6 IS	0482700000	B.40	QL 10 SAK4	0338200000	B.44	QL 2 SAKG46	0247000000	A.47	QL 3 SAKS4	0328100000	B.24
QB 2 WI RA6 IS	0482700000	B.57	QL 10 SAK6N	0338300000	A.31	QL 2 SAKG46	0247000000	B.52	QL 3 SAKS4	0328100000	I.9
QB 2 WI RA6 IS	0482700000	B.58	QL 10 SAK6N	0338300000	B.11	QL 2 SAKG46	0247000000	A.46	QL 3 SAKS4	0328100000	A.27
QB 2 WI RA6 IS	0482700000	A.20	QL 10 SAK6N	0338300000	I.9	QL 2 SAKG54	0264400000	A.47	QL 3 SAKS4	0328100000	A.26
QB 2 WI RA6 IS	0482700000	A.53	QL 10 SAK6N	0338300000	I.10						

Type	Order No.	Page	Type	Order No.	Page	Type	Order No.	Page	Type	Order No.	Page
QL 4 SAK35N	0565100000	B.9	RSF 2	0623320000	B.29	SAK 4 CUN/EP/SW	0168800000	D.6	SAKG 46/35 II	0637920000	A.46
QL 4 SAK35N	0565100000	A.9	RSF 3 PA	0497560000	B.28	SAK 4 EP/SW	0128300000	I.7	SAKG 46/35 II/GW	0638020000	A.47
QL 4 SAK35N	0565100000	A.5	RSF 3/35	9501160000	A.11	SAK 4 EP/SW	0128300000	D.6	SAKG 54 II	0170720000	B.53
QL 4 SAK35N	0565100000	I.9				SAK 4 KRG	0128320000	B.6	SAKG 54 II/GW	0185420000	B.53
QL 4 SAK4	0130800000	B.44				SAK 4 KRG BL	0128370000	I.7	SAKG 54/35 II	0638120000	A.47
QL 4 SAK4	0130800000	B.37	S			SAK 4 KRG BL	0128370000	B.6	SAKG 54/35 II/GW	0638220000	A.47
QL 4 SAK4	0130800000	A.38	SAK 10	0110060000	B.3	SAK 4 OR	0105060000	I.7	SAKG 70 II/GW	0150420000	B.50
QL 4 SAK4	0130800000	A.37	SAK 10 BL	0110080000	B.3	SAK 4 S 6.3/2.8	0401260000	B.37	SAKG 70/35 II/GW	0636620000	A.44
QL 4 SAK4	0130800000	I.10	SAK 10 BL	0110080000	I.7	SAK 4 S 6.3/2.8/KRG	0401220000	B.44	SAKH 10 CUN/EP/SW	1104700000	D.7
QL 4 SAK4	0130800000	I.9	SAK 10 KRG	0110020000	B.7	SAK 4 S/35 6.3/2.8	0630360000	A.37	SAKH 10 EP/SW	0126700000	I.7
QL 4 SAK6N	0194500000	A.11	SAK 10 KRG/BL	0110070000	I.7	SAK 4 SS 6.3/2.8	0479660000	B.37	SAKH 10 EP/SW	0126700000	D.7
QL 4 SAK6N	0194500000	I.9	SAK 10 KRG/BL	0110070000	B.7	SAK 4 SS 6.3/2.8 KRG	0479620000	B.44	SAKH 35 EP/SW	1596240000	D.7
QL 4 SAK6N	0194500000	A.33	SAK 10 OR	0110040000	I.7	SAK 4 SS 6.3/KRG	0352920000	B.44	SAKH 35 EP/SW	1596240000	I.7
QL 4 SAK6N	0194500000	B.28	SAK 10/35	0443760000	A.3	SAK 4 SS/35 6.3 GR	0646930000	I.7	SAKH 6 EP/SW	0126600000	I.7
QL 4 SAK6N	0194500000	B.32	SAK 10/35 BL	0443780000	A.3	SAK 4 SS/35 6.3/2.8	0630460000	A.38	SAKH 6 EP/SW	0126600000	D.6
QL 4 SAK6N	0194500000	I.21	SAK 10/35 BL	0443780000	I.7	SAK 4/35	0443660000	A.3	SAKH 10	9502610000	D.3
QL 4 SAK6N	0194500000	B.31	SAK 10/35 KRG	0443720000	A.8	SAK 4/35 BL	0443680000	A.3	SAKH 10 KER/WS	1598090000	D.3
QL 4 SAK6N	0194500000	A.32	SAK 10/35 KRG/BL	0443770000	A.8	SAK 4/35 BL	0443680000	I.7	SAKH 4	9502600000	D.2
QL 4 SAK6N	0194500000	I.10	SAK 10/35 KRG/BL	0443770000	I.7	SAK 4/35 KRG	0443620000	A.7	SAKH 4 KER/WS	1598080000	D.2
QL 4 SAKA10	0135700000	B.30	SAK 10/EN	0337660000	C.3	SAK 4/35 KRG/BL	0443670000	A.7	SAKR	0412160000	B.16
QL 4 SAKA10	0135700000	B.19	SAK 10/EN BL	1784410000	C.3	SAK 4/35 KRG/BL	0443670000	I.7	SAKR 15	0412760000	E.3
QL 4 SAKA10	0135700000	A.20	SAK 10/EN BL	1784410000	I.7	SAK 4/35 OR	1323660000	I.7	SAKR 15 2STB	0412860000	E.3
QL 4 SAKB10	0114500000	B.30	SAK 10/EN GR RAL 7042	1853960000	I.7	SAK 4/35/AP GG	0443650000	I.7	SAKR 2STB	0412260000	B.16
QL 4 SAKG28	0407700000	B.47	SAK 10/EN OR	1772830000	I.7	SAK 4/EN	0467460000	C.2	SAKR 2STB BL	0412280000	B.16
QL 4 SAKG28	0407700000	I.9	SAK 10/EN SW	0279900000	I.7	SAK 4/EN BL	0467480000	I.7	SAKR 2STB BL	0412280000	I.7
QL 4 SAKG28	0407700000	A.10	SAK 16	0271060000	B.4	SAK 4/EN BL	0467480000	C.2	SAKR 2STB KRG	0412220000	B.18
QL 4 SAKG28	0407700000	B.46	SAK 16 BL	0271080000	I.7	SAK 4/EN BR	9130990000	I.7	SAKR BL	0412180000	I.7
QL 4 SAKG28	0407700000	B.9	SAK 16 BL	0271080000	B.4	SAK 4/EN GE	9129930000	I.7	SAKR BL	0412180000	B.16
QL 4 SAKG32+70	0441600000	B.49	SAK 16 KRG	0271020000	B.7	SAK 4/EN GN	9129950000	I.7	SAKR KRG	0412120000	B.18
QL 4 SAKG32+70	0441600000	A.43	SAK 16/35 KRG	0380620000	A.9	SAK 4/EN GR	9129960000	I.7	SAKR LL	0464460000	B.40
QL 4 SAKG32+70	0441600000	A.42	SAK 16/35 PA	0380600000	A.4	SAK 4/EN GR 7042	1853950000	I.7	SAKR LL 2STB	0294260000	B.41
QL 4 SAKG32+70	0441600000	A.44	SAK 16/35 PA/BL	0380680000	I.7	SAK 4/EN OR	0467400000	I.7	SAKR LS 2STB	0518160000	B.40
QL 4 SAKG32+70	0441600000	B.48	SAK 16/35 PA/BL	0380680000	A.4	SAK 4/EN RT	9129920000	I.7	SAKR OR	1461960000	I.7
QL 4 SAKG32+70	0441600000	B.50	SAK 16/EN	0339760000	C.3	SAK 4/EN SW	9130980000	I.7	SAKR TS SE 1.6	0469360000	B.39
QL 4 SAKG40	0409800000	B.50	SAK 16/EN BL	1784390000	I.7	SAK 4/EN WS	1773340000	I.7	SAKR/35	0172160000	A.18
QL 4 SAKG40	0409800000	B.51	SAK 16/EN BL	1784390000	C.3	SAK 6/35 GN/GE	1866850000	I.7	SAKR/35 2STB BL	0183380000	I.7
QL 4 SAKG40/35	0445000000	A.45	SAK 2.5	0279660000	B.2	SAK 6/35 KRG	0380520000	A.8	SAKR/35 BL	0172180000	I.7
QL 4 SAKG46	0444500000	A.46	SAK 2.5 AL BLUE (E)	6253140000	I.7	SAK 6/35 KRG/BL	0380570000	A.8	SAKR/35 BL	0172180000	A.18
QL 4 SAKG46	0444500000	B.52	SAK 2.5 BL	0279680000	I.7	SAK 6/35 KRG/BL	0380570000	I.7	SAKR/35 WS	0172190000	I.7
QL 4 SAKG46	0444500000	A.47	SAK 2.5 BL	0279680000	B.2	SAK 6/35 PA	0380560000	A.3	SAKR/35	0185760000	A.18
QL 4 SAKG54	0247400000	B.53	SAK 2.5 BL	1817860000	I.7	SAK 6/35 PA/BL	0380580000	I.7	SAKS 1/32 G20 GL 115VAC	0385520000	B.22
QL 4 SAKG54	0247400000	A.47	SAK 2.5 KRG	0279620000	B.6	SAK 6/35 PA/BL	0380580000	A.3	SAKS 1/32 G20 GL 230VAC	0306120000	B.22
QL 4 SAKK 10	9502670000	D.3	SAK 2.5 KRG/BL	0279670000	I.7	SAK 6/EN	0212860000	C.3	SAKS 1/32 G20 LD 24VDC	0371420000	B.22
QL 4 SAKK 10 TIN	9509490000	D.3	SAK 2.5 KRG/BL	0279670000	B.6	SAK 6/EN BL	0212880000	I.7	SAKS 1/32 G25 GL 230VAC	0309320000	B.23
QL 4 SAKK 4	9502560000	D.2	SAK 2.5 LS KRG	0544120000	B.45	SAK 6/EN BL	0212880000	C.3	SAKS 1/35 G20 GL 115VAC	8068330000	A.24
QL 4 SAKK 4 TIN	9509440000	D.2	SAK 2.5 OR	1326360000	I.7	SAK 6/EN GE	1772820000	I.7	SAKS 1/35 G20 GL 230VAC	0199920000	A.24
QL 4 SAKS1	0191600000	A.25	SAK 2.5 SL	0351460000	B.39	SAK 6/EN OR	1772810000	I.7	SAKS 1/35 G20 LD 24VAC	1111320000	A.24
QL 4 SAKS1	0191600000	A.24	SAK 2.5 SW 1X1	0108560000	I.7	SAK 6/EN RT	0212840000	I.7	SAKS 1/35 G20 LD 24VDC	0225820000	A.24
QL 4 SAKS1	0191600000	B.23	SAK 2.5 SW 1X1	0108560000	B.38	SAK 6/EN SW	0212810000	I.7	SAKS 1/35 G20 LD 48VAC	0214020000	A.24
QL 4 SAKS1	0191600000	I.9	SAK 2.5 SW 1X1/KRG	0108520000	I.7	SAK 6/EN WS	1773350000	I.7	SAKS 1/35 G25 GL 230VAC	0198620000	A.25
QL 4 SAKS1	0191600000	B.22	SAK 2.5/35	0380460000	A.2	SAK 6N	0193260000	B.3	SAKS 1/35/G20	0501620000	A.24
QL 4 SAKS2	0208000000	A.27	SAK 2.5/35 BL	0380480000	A.2	SAK 6N BL	0193280000	I.7	SAKS 1/35/G25	0501520000	A.25
QL 4 SAKS2	0208000000	A.26	SAK 2.5/35 BL	0380480000	I.7	SAK 6N BL	0193280000	B.3	SAKS 1/G20	0191220000	B.22
QL 4 SAKS2	0208000000	I.9	SAK 2.5/35 DBL	1799920000	I.7	SAK 6N KRG	0193220000	B.7	SAKS 1/625	0191120000	B.23
QL 4 SAKS2	0208000000	B.24	SAK 2.5/35 GE	1821480000	I.7	SAK 70 KRG	0340820000	B.9	SAKS 2	0206820000	B.24
QL 4 SAKS2	0208000000	B.25	SAK 2.5/35 KRG	0380420000	A.7	SAK 70 KRG/BL	0340870000	B.9	SAKS 2/35	1368720000	A.26
QL 4 SAKS4	0328200000	I.9	SAK 2.5/35 KRG/BL	0380470000	A.7	SAK 70 KRG/BL	0340870000	I.7	SAKS 3 G/5X30 500V	0297520000	B.23
QL 4 SAKS4	0328200000	A.26	SAK 2.5/35 KRG/BL	0380470000	I.7	SAK 70/35	0139160000	A.6	SAKS 3 GZ/6.3X32	0248920000	B.23
QL 4 SAKS4	0328200000	B.25	SAK 2.5/35 LL	0567260000	A.40	SAK 95 KRG	0550520000	B.9	SAKS 3/35 G/5X30 500V	0328920000	A.25
QL 4 SAKS4	0328200000	B.24	SAK 2.5/35 OR	0380440000	I.7	SAK 95/35 KRG	0662220000	A.10	SAKS 3/35 GZ/6.3X32	0667520000	A.25
QL 4 SAKS4	0328200000	A.27	SAK 2.5/35 RT	1799910000	I.7	SAK 95/35 KRG/BL	0662270000	I.7	SAKS 4	0321320000	B.24
QL 5 SAK6N	0220500000	I.21	SAK 2.5/35 SW	1799900000	I.7	SAKA 10	0134120000	B.30	SAKS 4 USA	0162220000	B.25
QL 6 SAK6N	0220600000	I.21	SAK 2.5/35 SW 1X1	0514060000	I.7	SAKA 10/EN 2GL 230VAC	8109130000	C.8	SAKS 4/35	0501820000	A.26
QS 2/10/4	0270860000	I.13	SAK 2.5/EN	0218660000	C.2	SAKA 10/EN 2GL 24VUC	8150150000	C.8	SAKS 4/35 USA	0178220000	A.27
QS 2/10/4	0270860000	I.21	SAK 2.5/EN BL	0218680000	I.7	SAKB 10	0134920000	B.30	SAKS 5 380AC	0359420000	B.25
QS 2/12/4	0270760000	I.13	SAK 2.5/EN BL	0218680000	C.2	SAKC 10 2STB	0324120000	B.19	SAKS 5/35	0502120000	A.27
QS 2/12/4	0270760000	I.21	SAK 2.5/EN BR	1858450000	I.7	SAKC 10/35 1STB/4 KRG	1404520000	A.20	SAKT 1/35/DU1	0105820000	A.32
QS 2/6.5/2.3 SAK4	0212700000	I.13	SAK 2.5/EN SW	1858440000	I.7	SAKC 4 KRG	0340720000	B.19	SAKT 1/35/ST	0105420000	A.32
QS 2/8/4	0270960000	A.32	SAK 2.5/EN WS	1858460000	I.7	SAKC 4/2STB/7 BL	0340670000	I.7	SAKT 1/35/LT STB	0105620000	A.32
QS 2/8/4	0270960000	A.33	SAK 2.5/TC AL	0107160000	B.34	SAKC 4/35	0357520000	A.20	SAKT 1/35/QT1	0105720000	A.33
QS 2/8/4	0270960000	I.13	SAK 2.5/TC AL BL	0107180000	I.7	SAKD 2.5/35	0268860000	A.2	SAKT 1/35/QT2	0124620000	A.33
QS 2/8/4	0270960000	B.32	SAK 2.5/TC CH	0107260000	B.34	SAKD 2.5/35 BL	0268880000	I.7	SAKT 1/DU1	0195620000	B.31
QS 2/8/4	0270960000	B.31	SAK 2.5/TC CH BL	0107280000	I.7	SAKD 2.5/35 BL	0268880000	A.2	SAKT 1/DU2	0550420000	B.31
QS 2/8/4	0270960000	I.21	SAK 2.5/TC CU	0189860000	B.34	SAKD 2.5N	0215560000	B.2	SAKT 1/LT	0269120000	B.31
QVS 2 SAKT1+2	0307300000	B.31	SAK 2.5/TC CU	0189960000	B.34	SAKD 2.5N BL	0215580000	B.2	SAKT 1/LT STB1/4	0437920000	B.31
QVS 2 SAKT1+2	0307300000	A.32	SAK 2.5/TC FE	0190060000	B.34	SAKD 2.5N BL	0215580000	I.7	SAKT 1/QT1	0269320000	B.31
QVS 2 SAKT1+2	0307300000	I.20	SAK 35	0303560000	B.4	SAKE 35	0144400000	B.14	SAKT 1/QT2	0494820000	B.31
QVS 2 SAKT1+2	0307300000	A.33	SAK 35 BL	0303580000	B.4	SAKE 70/32	0213200000	B.15	SAKT 2/35/LT 4STB	0106020000	A.33
QVS 2 SAKT1+2	0307300000	B.32	SAK 35 KRG	0303520000	B.8	SAKG 28 I	0170020000	B.46	SAKT 2/35/LT/STB	0105920000	A.33
QVS 2/4 SAKT4	1319260000	B.32	SAK 35/35	0380760000	A.4	SAKG 28 II	0170320000	B.47	SAKT 2/LT 4STB	0437720000	B.32
QVS 2/4 SAKT4	1319260000	A.33	SAK 35/35 BL	0380780000	A.4	SAKG 28 II/GW	0185020000	B.47	SAKT 2/LT O.STB	0445420000	B.32
QVS 2/S SAKT1+2	0358460000	I.20	SAK 35/35 BL	0380780000	I.7	SAKG 28 III	0170820000	B.48	SAKT 2/LT STB	0330620000	B.32
QVS 3 SAKT1+2	0329300000										

Type	Order No.	Page	Type	Order No.	Page	Type	Order No.	Page	Type	Order No.	Page	
SCHT 7	0517960000	K.17	SS M3	D 128-A 3	0164400000	B.28	STB 14/D6/4/M3 SAK10	0169900000	B.28	STB 8.5/D4/2.3/M2.5 AKZ	0215700000	E.3
SCHT 9/4	1278460000	K.18	SS M3	D 128-A 3	0164400000	A.11	STB 14/D6/4/M3 SAK10	0169900000	I.15	STB 8.5/D4/2.3/M2.5 AKZ	0215700000	A.39
SD 0,4x2,0x60	9037160000	J.15	SS M3	D 128-A 3	0164400000	I.10	STB 14/D6/4/M3 SAK10	0169900000	B.31	STB 8.5/D4/2.3/M2.5 AKZ	0215700000	A.50
SD 0,4x2,5x75	9009030000	J.15	SS M4	D 128-A 4	0136400000	I.10	STB 16/D7/4/M4 SAK35	0140200000	B.5	STB 8.5/D4/2.3/M2.5 AKZ	0215700000	A.51
SD 0,5x3,0x80	9008320000	J.15	SS M4	D 128-A 4	0136400000	A.20	STB 16/D7/4/M4 SAK35	0140200000	A.5	STB 8.5/D4/2.3/M2.5 AKZ	0215700000	A.38
SD 0,6x3,5x100	9008330000	J.13	SS M4	D 128-A 4	0136400000	B.5	STB 16/D7/4/M4 SAK35	0140200000	I.15	STB 8.5/D4/2.3/M2.5 AKZ	0215700000	E.11
SD 0,6x3,5x100	9008330000	J.15	SS M4	D 128-A 4	0136400000	A.26	STB 16/D7/4/M4 SAK35	0140200000	B.4	STB 8.5/D4/2.3/M2.5 AKZ	0215700000	B.38
SD 0,6x3,5x200	9010110000	J.15	SS M4	D 128-A 4	0136400000	A.27	STB 16/D7/4/M4 SAK35	0140200000	A.9	STB 8.5/D4/2.3/M2.5 AKZ	0215700000	B.37
SD 0,8x4,0x100	9008340000	J.15	SS M4	D 128-A 4	0136400000	C.4	STB 16/D7/4/M4 SAK35	0140200000	A.4	STB 8.5/D4/2.3/M2.5 AKZ	0215700000	A.54
SD 0,8x4,5x125	9009020000	J.15	SS M4	D 128-A 4	0136400000	B.9	STB 16/D7/4/M4 SAK35	0140200000	C.4	STB 8.5/D4/2.3/M2.5 AKZ	0215700000	E.12
SD 1,0x5,5x150	9008350000	J.15	SS M4	D 128-A 4	0136400000	B.8	STB 16/D7/4/M4 SAK35	0140200000	B.9	STB 8.5/D4/2.3/M2.5 AKZ	0215700000	A.56
SD 1,2x6,5x150	9009010000	J.15	SS M4	D 128-A 4	0136400000	A.4	STB 16/D7/4/M4 SAK35	0140200000	B.8	STB 8.5/D4/2.3/M2.5 AKZ	0215700000	E.2
SD TH10	9009180000	J.15	SS M4	D 128-A 4	0136400000	B.9	STB 16/D7/4/M4 SAK35	0140200000	B.30	STB 8.5/D4/2.3/M2.5 AKZ	0215700000	E.8
SD TH15	9009170000	J.15	SS M4	D 128-A 4	0136400000	A.4	STB 16/D7/4/M5 SAK70	0385400000	A.10	STB 8.5/D4/2.3/M2.5 AKZ	0215700000	E.13
SD TH20	9009160000	J.15	SS M4	D 128-A 4	0136400000	B.24	STB 16/D7/4/M5 SAK70	0385400000	I.15	STB 8.5/D4/2.3/M2.5 AKZ	0215700000	B.61
SD TH25	9009150000	J.15	SS M4	D 128-A 4	0136400000	A.5	STB 16/D7/4/M5 SAK70	0385400000	B.9	STB 8.5/D4/2.3/M2.5 AKZ	0215700000	B.56
SD TH30	9009140000	J.15	SS M4	D 128-A 4	0136400000	B.19	STB 16/D7/4/M5 SAK70	0385400000	A.6	STB 8.5/D4/2.3/M2.5 AKZ	0215700000	B.57
SD TH8	9009190000	J.15	SS M4	D 128-A 4	0136400000	B.25	STB 17/D6/4/M4 SAKC10	0147100000	B.19	STB 8.5/D4/2.3/M2.5 AKZ	0215700000	B.58
SDI 0,4x2,5x75	9008370000	J.14	SS M5	D 128-A 5	0346100000	A.10	STB 17/D6/4/M4 SAKC10	0147100000	A.20	STB 8.5/D4/2.3/M2.5 AKZ	0215700000	A.12
SDI 0,5x3,0x100	9008380000	J.14	SS M5	D 128-A 5	0346100000	B.9	STB 17/D6/4/M4 SAKC10	0147100000	D.9	STB 8.5/D4/2.3/M2.5 AKZ	0215700000	A.55
SDI 0,6x3,5x100	9008390000	J.14	SS M5	D 128-A 5	0346100000	A.6	STB 17/D6/4/M4 SAKC10	0147100000	B.29	STI Waterproof schwarz	0508401694	K.24
SDI 0,8x4,0x100	9008400000	J.14	SSCH 10X3X1000 CU/SN		0348900000	G.7	STB 17/D6/4/M4 SAKC10	0147100000	I.15	STI Waterproof schwarz	0508401694	K.25
SDI 0,4X2,0X60	9205690000	J.14	SSCH 10X3X1000 CU/SN		0348900000	G.6	STB 25 IH/BL	0343400000	I.15	STL 5	0448460000	C.6
SDI 1,0x4,5x125	9009910000	J.14	SSCH 10X3X1000 CU/SN		0348900000	G.5	STB 25 IH/BL	0343400000	L.20	STR 15 F, ZGB 15	1636520000	K.19
SDI 1,0x5,5x150	9008410000	J.14	SSCH 10X3X1000 CU/SN		0348900000	G.4	STB 25 IH/GE	0267200000	L.20	STR 5 F.SCHT 5	0294000000	K.17
SDI 1,6x8,0x175	9008430000	J.14	SSCH 10X3X1000 CU/SN		0348900000	H.3	STB 25 IH/GE	0267200000	I.15	STR 5 S F.SCHT 5 S	1631940000	K.17
SDI 1.0X4.5X175	9205700000	J.14	SSCH 10X3X1000 CU/SN		0348900000	A.31	STB 25 IH/GR	0271200000	L.20	STR 7 F.SCHT 7	0153000000	K.17
SDI 1.0X5.5X175	9205710000	J.14	SSCH 10X3X1000 CU/SN		0348900000	A.30	STB 25 IH/GR	0271200000	I.15	STR 7 F.SCHT 7	0153000000	K.19
SDI T10	9009640000	J.14	SSCH 10X3X1000 MS/BK		0259800000	H.3	STB 25 IH/GR	0271400000	I.15	STRIPAX	9005000000	J.4
SDI T15	9009650000	J.14	SSCH 10X3X1000 ST/ZN		0438000000	H.3	STB 25 IH/GR	0271400000	L.20	STRIPAX 16	9005610000	J.4
SDI T20	9009660000	J.14	SSCH 10X3X1000 ST/ZN		1746130000	G.5	STB 25 IH/RT	0343300000	I.15	STRIPAX PLUS 2.5	9020000000	J.5
SDI T25	9009670000	J.14	SSCH 10X3X1000 ST/ZN		1746130000	G.7	STB 25 IH/RT	0343300000	L.20	STRIPAX PLUS 2.5	9020000000	J.35
SDI T30	9009680000	J.14	SSCH 10X3X1000 ST/ZN		1746130000	G.4	STB 25 IH/SW	0271500000	I.15	SWIFTY	9006020000	J.13
SDI T40	9009690000	J.14	SSCH 15X6X1000 CU/SN		0357400000	H.3	STB 25 IH/SW	0271500000	L.20	SWIFTY SET	9006060000	J.13
SDI T8	9201940000	J.14	SSCH 6X6X1000 CU/SN		0571300000	H.3	STB 25 IH/VI	0271300000	L.20			
SDIK PH0	9008560000	J.14	SSCH 6X6X1000 MS/BK		0571200000	H.3	STB 25 IH/VI	0271300000	I.15			
SDIK PH1	9008570000	J.14	SSP 3 SAKT1		0531760000	A.33	STB 28.5 IH/SW SAK2.5	0133400000	I.15			
SDIK PH2	9008580000	J.14	SSP 3 SAKT1		0531760000	B.31	STB 30.5 IH/BL	0341200000	L.20	TA 1	0535860000	I.14
SDIK PH3	9008590000	J.14	SSP 3 SAKT1		0531760000	A.32	STB 30.5 IH/BL	0341200000	I.15	TB 2	1287860000	I.17
SDIK P21	9008900000	J.14	SSP 3 SAKT1		0531760000	L.20	STB 30.5 IH/GE	0341500000	I.15	TH-S 9-40	9008880000	J.16
SDIK P22	9008890000	J.14	SSP 3 SAKT1		0531760000	B.32	STB 30.5 IH/GE	0341500000	L.20	Tinte 2000 25ml	1772120000	K.25
SDIZ 0.6X3.5X100	9008450000	J.20	SSP 4 SAKT4		1319360000	L.20	STB 30.5 IH/GR	0341400000	L.20	Tinte 2000 25ml	1772120000	K.24
SDIZ 0.8X4.0X100	9008460000	J.20	SSP 4 SAKT4		1319360000	A.33	STB 30.5 IH/GR	0341400000	I.15	Tintenpatrone PrintJet	1797460000	K.22
SDK PH0	9008470000	J.15	SSP 4 SAKT4		1319360000	B.32	STB 30.5 IH/GR	0341100000	L.20	Tonerbank PrintJet II	1858920000	K.22
SDK PH1	9008480000	J.15	ST 5 PA/BE		0448360000	C.6	STB 30.5 IH/GR	0341100000	I.15	TONER SMARK LASER	1770070000	K.21
SDK PH2	9008490000	J.15	STA 2.5/2		0165860000	B.43	STB 30.5 IH/RT	0341300000	L.20	TS 15x5 2M/AL/BK	0134700000	H.10
SDK PH3	9008500000	J.15	STA 2.5/2		0165860000	A.36	STB 30.5 IH/RT	0341300000	I.15	TS 15x5 2M/ST/ZN	0514200000	H.10
SDK P20	9008520000	J.15	STA 2.5/2		0165860000	A.37	STB 30.5 IH/SW	0341000000	L.20	TS 15x5/LL 1M/ST/ZN	0117510000	H.10
SDK P21	9008530000	J.15	STA 2.5/2		0165860000	B.42	STB 30.5 IH/SW	0341000000	I.15	TS 15x5/LL 2M/AL/BK	0217900000	H.10
SDK P22	9008540000	J.15	STA 2.5/2		0165860000	A.36	STB 30.5 IH/VI	0341600000	I.15	TS 15x5/LL 2M/ST/ZN	0117500000	H.10
SDK P23	9008550000	J.15	STA 2.5/3		0165960000	A.37	STB 30.5 IH/VI	0341600000	L.20	TS 27x12.5M/ST/F.ZN	1802690000	G.11
SH 1	0299860000	H.4	STA 2.5/3		0165960000	B.36	STB 35 IH/BL	0388700000	L.20	TS 32x15 2M/AL/BK	0169300000	H.10
SH 2	0494920000	A.14	STA 2.5/3		0165960000	B.42	STB 35 IH/BL	0388700000	I.15	TS 32x15 2M/CRN	0293220000	H.10
SH 2	0494920000	A.15	STA 2.5/3		0165960000	B.43	STB 35 IH/GE	0389000000	I.15	TS 32x15 2M/ST/ZN	0122800000	H.10
SH 2	0494920000	A.16	STA 2.5/3		0165960000	A.46	STB 35 IH/GE	0389000000	L.20	TS 32x15/LL 2M/ST/ZN	0514400000	H.10
SH 2	0494920000	A.17	STA 2.5/4		0190360000	B.32	STB 35 IH/GR	0388900000	L.20	TS 32x16.2 2M/AL/BK	0364300000	H.10
SH 2	0494920000	B.15	STA 2.5/4		0190360000	B.36	STB 35 IH/GR	0388900000	I.15	TS 35x15 2M/ST/ZN	0236400000	H.11
SH 2	0494920000	H.4	STA 2.5/4		0190360000	A.37	STB 35 IH/GR	0388600000	L.20	TS 35x15/2.3 2M/AL/BK	1848290000	H.11
SH 2	0494920000	B.14	STA 2.5/4		0190360000	A.36	STB 35 IH/GR	0388600000	I.15	TS 35x15/2.3 2M/AL/BK	0270100000	H.11
SH 2	0494920000	B.13	STA 2.5/4		0190360000	B.43	STB 35 IH/RT	0388800000	I.15	TS 35x15/2.3 2M/ST/ZN	0498000000	H.11
SH 2	0494920000	B.12	STA 2.5/5		0166060000	B.42	STB 35 IH/RT	0388800000	L.20	TS 35x15/6X18 2M/ST/ZN	1805980000	H.11
SH 2	0494920000	L.12	STA 2.5/5		0166060000	B.43	STB 35 IH/SW	0388500000	L.20	TS 35x15/6X25 2M/ST/ZN	1866290000	H.11
SH 2 S	0641720000	H.4	STA 2.5/5		0166060000	B.36	STB 35 IH/SW	0388500000	I.15	TS 35x15/LL 1M/ST/ZN	0236510000	H.11
SH 3	0556660000	H.4	STA 2.5/5		0166060000	A.36	STB 35 IH/VI	0389100000	L.20	TS 35x15/LL 2M/ST/ZN	0236500000	H.11
SK 10,0x125	9009070000	J.15	STA 2.5/5		0166060000	A.37	STB 35 IH/VI	0389100000	I.15	TS 35x7.5 2M/AL/BK	0330900000	H.11
SK 11,0x125	9009060000	J.15	STA 2.5/8		0166160000	B.42	STB 5.5/D3.7/2.3/M3 ZB	0122700000	I.15	TS 35x7.5 1M/ST/ZN	0383410000	H.11
SK 12,0x125	9009050000	J.15	STA 2.5/8		0166160000	A.36	STB 6/D3.7/2.3/M3 SAKR	0379400000	B.16	TS 35x7.5 2M/AL/BK	0330900000	H.11
SK 13,0x125	9009040000	J.15	STA 2.5/8		0166160000	B.36	STB 6/D3.7/2.3/M3 SAKR	0379400000	B.18	TS 35x7.5 2M/CRN	1747350000	H.11
SK 5,5x125	9009120000	J.15	STA 2.5/8		0166160000	B.43	STB 6/D3.7/2.3/M3 SAKR	0379400000	B.40	TS 35x7.5 2M/ST/ZN	0383400000	H.11
SK 6,0x125	9009110000	J.15	STA 2.5/8		0166160000	A.37	STB 6/D3.7/2.3/M3 SAKR	0379400000	A.18	TS 35x7.5/LL 1M/ST/ZN	0514510000	H.11
SK 7,0x125	9009100000	J.15	STB 13.5/D6/4/M4 SAKA10		0135200000	B.30	STB 6/D3.7/2.3/M3 SAKR	0379400000	I.15	TS 35x7.5/LL 2M/ST/ZN	0514500000	H.11
SK 8,0x125	9009090000	J.15	STB 13.5/D6/4/M4 SAKA10		0135200000	I.15	STB 6/D3.9/2.3/M2.5 ZB	0130200000	B.6	TS 35x7.5/LL 6M/ST/ZN	0514570000	H.11
SK 9,0x125	9009080000	J.15	STB 14/D5/2.3/M3 SAK2.5		0168600000	A.11	STB 6/D3.9/2.3/M2.5 ZB	0130200000	I.15	TSC 1	0319160000	A.9
SK E14 SAKS4	0339410000	A.26	STB 14/D5/2.3/M3 SAK2.5		0168600000	B.3	STB 7.5/D6/4/M4 ZB/SAKB	0130000000	I.15	TSC 1	0319160000	B.2
SK E14 SAKS4	0339410000	B.24	STB 14/D5/2.3/M3 SAK2.5		0168600000	B.28	STB 7/D4/2.3/M3 ZB/SAKC	0358500000	B.19	TSC 1	0319160000	A.8
SK E14 SAKS4 USA	2012790000	B.25	STB 14/D5/2.3/M3 SAK2.5		0168600000	B						

Type	Order No.	Page	Type	Order No.	Page	Type	Order No.	Page	Type	Order No.	Page
TSCH 2	0353660000	B.32	TW SAK2.5 KRG/BL	0302870000	B.6	VH 10/4/2.8 AKZ4	0446600000	A.56	VL 2 SAK16/SAKA	0135800000	A.9
TSCH 2	0353660000	A.32	TW SAK2.5 KRG/BL	0302870000	A.7	VH 10/4/2.8 AKZ4	0446600000	A.55	VL 2 SAK16/SAKA	0135800000	B.4
TSCH 3 SAKD2.5 N	0366860000	B.2	TW SAK2.5-35/32 KRG	0257120000	B.30	VH 10/4/2.8 AKZ4	0446600000	E.12	VL 2 SAK16/SAKA	0135800000	C.3
TSCH 3 SAKD2.5 N	0366860000	A.2	TW SAK35	0304360000	A.5	VH 10/4/2.8 AKZ4	0446600000	B.56	VL 2 SAK16/SAKA	0135800000	B.7
TSCH 4 AKZ4	0363360000	E.13	TW SAK35	0304360000	C.4	VH 10/4/2.8 AKZ4	0446600000	A.50	VL 2 SAK35	0124000000	A.4
TSCH 4 AKZ4	0363360000	A.55	TW SAK35	0304360000	B.4	VH 10/4/2.8 AKZ4	0446600000	A.54	VL 2 SAK35	0124000000	B.4
TSCH 4 AKZ4	0363360000	B.57	TW SAK35	0304360000	A.4	VH 10/4/2.8 AKZ4	0446600000	B.59	VL 2 SAK35	0124000000	B.5
TSCH 4 AKZ4	0363360000	A.51	TW SAK35	0304360000	B.5	VH 12.5 SAKK10	9502690000	D.3	VL 2 SAK35	0124000000	A.5
TSCH 4 AKZ4	0363360000	A.53	TW SAK35 KRG	0304320000	B.9	VH 12.5 SAKK10	9509510000	D.3	VL 2 SAK35	0124000000	I.12
TSCH 4 AKZ4	0363360000	E.3	TW SAK35 KRG	0304320000	A.9	VH 12.5/5/3.5 SAK10-2.5	0300800000	I.10	VL 2 SAK35	0124000000	B.8
TSCH 4 AKZ4	0363360000	A.54	TW SAK35 KRG	0304320000	B.8	VH 12.4/9/3.3 SAK6N	0249000000	B.32	VL 2 SAK4	0197000000	I.12
TSCH 4 AKZ4	0363360000	A.52	TW SAK4-10 EP/SW	0130100000	D.6	VH 12.4/9/3.3 SAK6N	0249000000	B.31	VL 2 SAK4	0197000000	C.4
TSCH 4 AKZ4	0363360000	E.12	TW SAK4-10 KRG	0130120000	A.8	VH 12.4/9/3.3 SAK6N	0249000000	I.10	VL 2 SAK4	0197000000	C.2
TSCH 4 AKZ4	0363360000	E.11	TW SAK4-10 KRG	0130120000	B.44	VH 12.4/9/3.3 SAK6N	0249000000	A.32	VL 2 SAK4	0197000000	B.6
TSCH 4 AKZ4	0363360000	B.60	TW SAK4-10 KRG	0130120000	A.20	VH 12.4/9/3.3 SAK6N	0249000000	I.21	VL 2 SAK4	0197000000	A.7
TSCH 4 AKZ4	0363360000	B.56	TW SAK4-10 KRG	0130120000	B.6	VH 12.4/9/3.3 SAK6N	0249000000	I.9	VL 2 SAK4	0197000000	C.5
TSCH 4 AKZ4	0363360000	B.59	TW SAK4-10 KRG	0130120000	A.7	VH 12.4/9/3.3 SAK6N	0249000000	A.33	VL 2 SAK4	0197000000	B.3
TSCH 4 AKZ4	0363360000	B.38	TW SAK4-10 KRG	0130120000	B.7	VH 12.4/9/3.3 SAK6N	0249000000	I.9	VL 2 SAK4	0197000000	A.3
TSCH 4 AKZ4	0363360000	A.50	TW SAK4-10 KRG	0130120000	B.19	VH 13.5 SAKK 4	9502580000	D.2	VL 2 SAK6/10/SAKB	0135900000	B.7
TSCH 4 AKZ4	0363360000	B.61	TW SAK4-10 KRG/BL	0130170000	A.8	VH 13.5 SAKK4	9509460000	D.2	VL 2 SAK6/10/SAKB	0135900000	A.3
TSCH 4 AKZ4	0363360000	E.10	TW SAK4-10 KRG/BL	0130170000	A.7	VH 13.5/4.9/3.3 SAK4	0248500000	A.11	VL 2 SAK6/10/SAKB	0135900000	B.3
TSCH 4 AKZ4	0363360000	B.58	TW SAK4-10 KRG/BL	0130170000	A.20	VH 13.5/4.9/3.3 SAK4	0248500000	I.9	VL 2 SAK6/10/SAKB	0135900000	I.12
TSCH 6 DKI S4	1902600000	B.37	TW SAK4-10 KRG/BL	0130170000	B.19	VH 13.5/4.9/3.3 SAK4	0248500000	I.10	VL 2 SAK6/10/SAKB	0135900000	A.8
TSCH 6 DKI S4	1902600000	A.38	TW SAK4-10 KRG/BL	0130170000	B.7	VH 13.5/4.9/3.3 SAK4	0248500000	B.28	VL 2 SAK6N/SAKT	0194700000	A.8
TSCH 6 DKI S4	1902600000	A.39	TW SAK4-10 KRG/BL	0130170000	B.6	VH 13.6/7/4.2 SAKA10	0299700000	A.20	VL 2 SAK6N/SAKT	0194700000	A.3
TSCH 6 DKI S4	1902600000	B.10	TW SAK4-10 KRG/BL	0130170000	B.44	VH 13.6/7/4.2 SAKA10	0299700000	B.19	VL 2 SAK6N/SAKT	0194700000	C.3
TSCH 6 DKI S4	1902600000	A.12	TW SAKB/C/T1	0242960000	A.20	VH 13/5/3.5 SAK 10	0304000000	I.10	VL 2 SAK6N/SAKT	0194700000	B.7
TSCH 6 DKI S4	1902600000	B.11	TW SAKB/C/T1	0242960000	B.32	VH 16/5/3.5 SAK10-35	0309700000	I.10	VL 2 SAK6N/SAKT	0194700000	B.28
TSCH 6 DKI S4	1902600000	A.13	TW SAKB/C/T1	0242960000	A.32	VH 16/5/3.5 SAK10-35	0309700000	A.33	VL 2 SAK6N/SAKT	0194700000	I.12
TSK 31.5 GR	0347960000	L.16	TW SAKB/C/T1	0242960000	A.33	VH 16/5/3.5 SAK10-35	0309700000	B.32	VL 2 SAK6N/SAKT	0194700000	A.11
TSK 35X15 2M PVC/GR	0514300000	H.12	TW SAKB/C/T1	0242960000	B.31	VH 17/8/5 SAK35	0267000000	A.9			
TST 2/M5	1286600000	H.14	TW SAKB-C-T	0242920000	B.30	VH 17/8/5 SAK35	0267000000	B.4			
TST 2/M6	0101700000	H.14	TW SAKB-C-T	0242920000	A.20	VH 17/8/5 SAK35	0267000000	I.10			
TSTW 5/M5	0178100000	H.14	TW SAKB-C-T	0242920000	B.19	VH 17/8/5 SAK35	0267000000	B.9	WAD 12 M. BL	1055960000	K.18
TSTW 5/M5 ZN	1779100000	H.14	TW SAKD2.5N	0191860000	A.2	VH 17/8/5 SAK35	0267000000	A.5	WAD 12 NEUTRAL	1056260000	K.18
TSTW 6/M6	0164000000	H.14	TW SAKD2.5N	0191860000	B.2	VH 17/8/5 SAK35	0267000000	B.5	WAD 27 M. BL	1062860000	K.18
TSTW D 4.3	1610110000	H.14	TW SAKD2.5N BL	0191880000	B.2	VH 17/8/5 SAK35	0267000000	B.2	WAD 27 NEUTRAL	1062960000	K.18
TW 4 SAK4-10	0130160000	C.4	TW SAKD2.5N BL	0191880000	A.2	VH 17/8/5 SAK35	0267000000	C.4	WAD 5 M. BL	1053460000	K.18
TW 4 SAK4-10	0130160000	C.5	TW SAKG28 HP/DBR/2	0151400000	B.47	VH 17/8/5 SAK35	0267000000	B.8	WAD 5 NEUTRAL	1056060000	K.18
TW 4 SAK4-10	0130160000	B.3	TW SAKG28 HP/DBR/2	0151400000	B.46	VH 17/8/5 SAK35	0267000000	I.9	WAD 5 Sonderdruck	1790060000	K.18
TW 4 SAK4-10	0130160000	B.37	TW SAKG28 HP/DBR/2	0151400000	B.48	VH 19/5/3.5 SAK4-16	0285100000	B.6	WAD 8 M. BL	1053560000	K.18
TW 4 SAK4-10	0130160000	A.38	TW SAKG28 HP/DBR/2	0151400000	A.44	VH 19/5/3.5 SAK4-16	0285100000	B.3	WAD 8 NEUTRAL	1056160000	K.18
TW 4 SAK4-10	0130160000	C.2	TW SAKG28 HP/DBR/2	0151400000	A.49	VH 19/5/3.5 SAK4-16	0285100000	B.7	WAD 8 SONDERDRUCK	1667700000	K.18
TW 4 SAK4-10	0130160000	A.37	TW SAKG28 HP/DBR/2	0151400000	B.43	VH 19/5/3.5 SAK4-16	0285100000	A.4	WAW 1 NEUTRAL	9004500000	J.3
TW 4 SAK4-10	0130160000	A.36	TW SAKG28 HP/DBR/2	0151400000	B.50	VH 19/5/3.5 SAK4-16	0285100000	B.4	WAW 2	9004510000	J.3
TW 4 SAK4-10	0130160000	A.44	TW SAKG28 HP/TF/GE/2	0164600000	A.43	VH 19/5/3.5 SAK4-16	0285100000	A.3	WEW 32/1	1067600000	H.13
TW 4 SAK4-10	0130160000	B.3	TW SAKG28 HP/TF/GE/2	0164600000	A.44	VH 19/5/3.5 SAK4-16	0285100000	C.5	WEW 35/1	1059000000	H.5
TW 4 SAK4-10	0130160000	C.3	TW SAKG28 HP/TF/GE/2	0164600000	B.47	VH 19/5/3.5 SAK4-16	0285100000	A.8	WEW 35/2	1061200000	H.13
TW 4 SAK4-10 BL	0130180000	C.5	TW SAKG28 HP/TF/GE/2	0164600000	B.50	VH 19/5/3.5 SAK4-16	0285100000	C.2	WEW 35/2	1061200000	H.5
TW 4 SAK4-10 BL	0130180000	C.4	TW SAKG28 HP/TF/GE/2	0164600000	B.46	VH 19/5/3.5 SAK4-16	0285100000	I.12	WGB 5 ABDG.M.GRUPPENBEZ	1050760000	K.18
TW 4 SAK4-10 BL	0130180000	A.3	TW SAKG28 HP/TF/GE/2	0164600000	B.48	VH 19/5/3.5 SAK4-16	0285100000	C.3	WGB 8 ABDG.M.GRUPPENBEZ	1050960000	K.18
TW 4 SAK4-10 BL	0130180000	C.3	TW SAKG28 HP/TF/GE/2	0164600000	B.49	VH 19/5/3.5 SAK4-16	0285100000	A.7	WK IK PH0	9918460000	J.19
TW 4 SAK4-10 BL	0130180000	C.2	TW SAKG46 HP/DBR/2	0177100000	B.52	VH 19/5/3.5 SAK4-16	0285100000	C.4	WK IK PH1	9918470000	J.19
TW 4 SAK4-10 BL	0130180000	B.3	TW SAKG46 HP/DBR/2	0177100000	A.42	VH 19/5/3.5 SAK4-16	0285100000	A.9	WK IK PH2	9918480000	J.19
TW ADK1 HP/DBR/0.5	0442300000	E.11	TW SAKG46 HP/DBR/2	0177100000	A.49	VH 19/6/4.2 SAKT1	0318000000	B.32	WK IK PZ0	9918490000	J.19
TW AK22.5	0318560000	E.2	TW SAKG46 HP/DBR/2	0177100000	B.43	VH 19/6/4.2 SAKT1	0318000000	A.32	WK IK PZ1	9918500000	J.19
TW AK22.5	0318560000	E.13	TW SAKG46 HP/DBR/2	0177100000	A.47	VH 19/6/4.2 SAKT1	0318000000	A.33	WK IK PZ2	9918510000	J.19
TW AK22.5 BL	0318580000	E.2	TW SAKG46 HP/DBR/2	0177100000	B.53	VH 19/6/4.2 SAKT1	0318000000	B.31	WK IK PH0	9918570000	J.18
TW AK24	0348260000	E.9	TW SAKG46 HP/DBR/2	0177100000	B.48	VH 19/6/4.2 SAKT1	0318000000	I.21	WK K PH1	9918580000	J.18
TW AK24	0348260000	E.13	TW SAKG46 HP/DBR/2	0177100000	A.44	VH 21/5/3.5 SAK16-35	0309600000	A.11	WK K PH2	9918590000	J.18
TW AK24	0348260000	E.12	TW SAKG46 HP/DBR/2	0177100000	B.50	VH 21/5/3.5 SAK16-35	0309600000	B.28	WK K PZ0	9918600000	J.18
TW AK24	0348260000	E.3	TW SAKG46 HP/DBR/2	0177100000	A.46	VH 23/6/4.2 SAKA10	0348700000	B.30	WK K PZ1	9918610000	J.18
TW AK24	0348260000	E.8	TW SAKG46 HP/DBR/2	0177100000	B.51	VH 24.5/8/5 SAK35	0298700000	A.5	WK K PZ2	9918620000	J.18
TW AK24	0348260000	E.11	TW SAKG46 HP/DBR/2	0177100000	A.45	VH 24.5/8/5 SAK35	0298700000	B.8	WK S 0,4x2,5	9918520000	J.18
TW AK24	0348260000	E.10	TW SAKG46 HP/TF/GE/2	0179900000	B.52	VH 24.5/8/5 SAK35	0298700000	A.4	WK S 0,5x3,0	9918530000	J.18
TW AK24 BL	0348280000	E.3	TW SAKG46 HP/TF/GE/2	0179900000	A.42	VH 24.5/8/5 SAK35	0298700000	B.5	WK S 0,6x3,5	9918540000	J.18
TW AK24 HP/DBR/0.5	0166800000	A.10	TW SAKG46 HP/TF/GE/2	0179900000	A.45	VH 24.5/8/5 SAK35	0298700000	I.12	WK S 0,8x4,0	9918550000	J.18
TW AST1/PA HP/DBR/0.5	0474700000	E.11	TW SAKG46 HP/TF/GE/2	0179900000	B.49	VH 24.5/8/5 SAK35	0298700000	B.4	WK S 1,0x5,5	9918560000	J.18
TW AST1/PA HP/DBR/0.5	0474700000	B.28	TW SAKG46 HP/TF/GE/2	0179900000	B.48	VH 27/5/3.5 SAK10-35	0309400000	I.10	WK SI 0,4x2,5	9918410000	J.19
TW AST1/PA HP/DBR/0.5	0474700000	A.37	TW SAKG46 HP/TF/GE/2	0179900000	A.44	VH 27/5/3.5 SAK10-35	0309400000	B.28	WK SI 0,5x3,0	9918420000	J.19
TW AST1/PA HP/DBR/0.5	0474700000	B.41	TW SAKG46 HP/TF/GE/2	0179900000	B.53	VH 30.5/11/5.5 SAK70	0345500000	I.28	WK SI 0,6x3,5	9918430000	J.19
TW AST1/PA HP/DBR/0.5	0474700000	B.32	TW SAKG46 HP/TF/GE/2	0179900000	B.50	VH 30.5/11/5.5 SAK70	0345500000	B.9	WK SI 0,8x4,0	9918440000	J.19
TW AST1/PA HP/DBR/0.5	0474700000	A.33	TW SAKG46 HP/TF/GE/2	0179900000	A.47	VH 30.5/11/5.5 SAK70	0345500000	A.6	WK SI 1,0x5,5	9918450000	J.19
TW AST1/PA HP/DBR/0.5	0474700000	B.36	TW SAKG46 HP/TF/GE/2	0179900000	B.51	VH 35/11/5.5 SAK95	0551100000	I.9	WS 10/12 MC NEUTRAL	1905970000	K.15
TW KST5-12 LI/NO 160/HM	1752800000	A.49	TW SAKG46 HP/TF/GE/2	0179900000	A.46	VH 35/11/5.5 SAK95	0551100000	B.9	WS 10/12 MC SONDERDRUCK	1906060000	K.15
TW KST5-12 LI/NO 160/HM	1752800000	A.48	TW SAKG46 HP/TF/GE/2	0179900000	A.43	VH 35/11/5.5 SAK95	0551100000	A.10	WS 10/15 MC Neutr.	1854090000	K.15
TW KST5-12 LI/NO 160/HM	1752800000	B.55	TW SAKS2 HP/DBR/2	0607000000	B.36	VH 4.5/5/3.5 SAK6N-16	0303200000	I.10	WS 10/15 MC Sonderdruck	1854100000	K.15
TW KST5-12 LI/NO 160/HM	1752800000	B.54	TW SAKS2 HP/DBR/2	0607000000	A.36	VH 5/4/2.8 AKZ4	0296800000	I.9	WS 10/5 MC BEDRUCKT	1635010000	K.14
TW KST5-12 RE/NO 160											

Type	Order No.	Page	Type	Order No.	Page
WS 12/5 FSZ 1-10	1773430001	K.9	ZEW 35/2	8630740000	H.13
WS 12/5 FSZ 11-20	1773430011	K.9	ZF 4 S	1814680000	H.7
WS 12/5 FSZ 21-30	1773430021	K.9	ZF 4 S BL	1814660000	H.7
WS 12/5 FSZ 31-40	1773430031	K.9	ZF 4 S GN	1814670000	H.7
WS 12/5 FSZ 41-50	1773430041	K.9	ZGB 15	1636530000	K.19
WS 12/5 FWZ 1-10	1773330001	K.9	ZGB 30	1611930000	K.19
WS 12/5 FWZ 11-20	1773330011	K.9	ZS 10/5 MC BEDRUCKT	1610010000	K.15
WS 12/5 FWZ 21-30	1773330021	K.9	ZS 10/5 MC NEUTRAL	1610000000	K.15
WS 12/5 FWZ 31-40	1773330031	K.9	ZS 12/6 BEDRUCKT	1610030000	K.15
WS 12/5 FWZ 41-50	1773330041	K.9	ZS 12/6 MC NEUTRAL	1610020000	K.15
WS 12/5 MC BEDRUCKT	1609870000	K.14	ZS 15/5 MC BEDRUCKT	1646640000	K.15
WS 12/5 MC NEUTRAL	1609860000	K.14	ZS 15/5 MC NEUTRAL	1646630000	K.15
WS 12/5 MC NEUTRAL	1609860000	K.18	ZS 2.3/4	0249600000	I.14
WS 12/5 MC NEUTRAL	1609860000	K.19	ZU 1	0240600000	I.5
WS 12/5 MC neutral BL	1773541693	K.14			
WS 12/5 MC neutral GE	1773541687	K.14			
WS 12/5 MC neutral OR	1773541690	K.14			
WS 12/5 MC neutral RT	1773541686	K.14			
WS 12/5 PLUS MC NEUTRAL	1927510000	K.14			
WS 12/5 PLUS SONDERDRUCK	1927520000	K.14			
WS 12/5 Sonderdr. Laser	1773380000	K.9			
WS 12/6 MC BEDRUCKT	1609910000	K.15			
WS 12/6 MC NEUTRAL	1609900000	K.14			
WS 12/6 MC neutral BL	1773551693	K.14			
WS 12/6 MC neutral BR	1773551692	K.14			
WS 12/6 MC neutral GE	1773551687	K.14			
WS 12/6 MC neutral OR	1773551690	K.14			
WS 12/6 MC neutral RT	1773551686	K.14			
WS 12/6 MC neutral VI	1773551689	K.14			
WS 12/6 PLUS MC NEUTRAL	1927530000	K.14			
WS 12/6 PLUS SONDERDRUCK	1927540000	K.15			
WS 12/6,5 MC BEDRUCKT	1609930000	K.15			
WS 12/6,5 MC NEUTRAL	1609920000	K.15			
WS 12/6,5 MC neutral BL	1773561693	K.15			
WS 12/6,5 MC neutral GE	1773561687	K.15			
WS 12/6,5 MC neutral GN	1773561688	K.15			
WS 12/6,5 MC neutral RT	1773561686	K.15			
WS 12/8 MC NEUTRAL	1906000000	K.15			
WS 12/8 MC SONDERDRUCK	1906010000	K.15			
WS 14/5 MC NEUTRAL	1768090000	K.14			
WS 15/5 MC BEDRUCKT	1609890000	K.14			
WS 15/5 MC NEUTRAL	1609880000	K.14			
WS 15/5 MC neutral GE	1773571687	K.14			
WS 8/5 MC BEDRUCKT	1640750000	K.14			
WS 8/5 MC NEUTRAL	1640740000	K.14			
WS 8/5 MC neutral BL	1773521693	K.14			
WS 8/5 MC neutral GE	1773521687	K.14			
WS 8/5 MC neutral OR	1773521690	K.14			
WS 8/5 MC neutral RT	1773521686	K.14			
WS 8/5 PLUS MC NEUTRAL	1951870000	K.14			
WS 8/5 Sonderdr. Laser	1773360000	K.9			
WS 8/6 PLUS MC NEUTRAL	1951880000	K.14			
WSH 1	1068700000	G.6			
WSH 18 MT	1083100000	G.7			
WSH 19 MT	1083200000	G.7			
WSH 20 MT	1752950000	G.7			
WSH 3/H/N	1715970000	G.6			
WSH 4 MT	1079900000	G.9			
WSH 5	1080100000	G.6			
WSH 6	1080200000	G.6			
WTW EN	1058800000	A.12			
WTW EN	1058800000	B.10			
WTW EN	1058800000	A.13			
WTW EN	1058800000	A.34			
WTW EN	1058800000	B.11			
WTW EN	1058800000	B.34			

Z

ZB 10 F.10X3/10X5/10X10	1261300000	H.6
ZB 16 ZKSC	0316600000	A.30
ZB 16 ZKSC	0316600000	A.31
ZB 16 ZKSC	0316600000	H.6
ZB 16/6	0556800000	H.6
ZB 16/6K GE/GN	0569660000	H.7
ZB 16K BL	0502880000	H.7
ZB 16K GE/GN	0502860000	H.7
ZB 35/M6X16	0266500000	A.30
ZB 35/M6X16	0266500000	A.31
ZB 35/M6X16	0266500000	H.6
ZB 35K BL M6X16	0502680000	H.7
ZB 35K GE/GN M6X16	0502660000	H.7
ZB 35K SW M6X16	0502610000	H.7
ZB 4	0316500000	H.6
ZB 4	0316500000	A.30
ZB 4	0316500000	A.31
ZB 4/6	0556700000	H.6
ZB 4/6K BL	0565480000	H.7
ZB 4/6K GE/GN	0565460000	H.7
ZB 4G BL	0322180000	H.7
ZB 4G GN/GE	0322160000	H.7
ZB 4G SW	0322110000	H.7
ZB 4K BL	0475380000	H.7
ZB 4K GE/GN	0475360000	H.7
ZBE 6	0459500000	H.6
ZBE 6K BL	0525980000	H.7
ZBE 6K GE/GN	0525960000	H.7
ZBE 6K SW	0525910000	H.7
ZEW 15	7920340000	H.13
ZEW 35	9540000000	H.13

Order No.	Type	Page
-----------	------	------

0050000000

0053160000	DK 4/35 RC 220R/220N	A.56
------------	----------------------	------

0100000000

0101700000	TST 2/M6	H.14
0103300000	BFSC M4X9T	A.26
0103300000	BFSC M4X9T	B.24
0103300000	BFSC M4X9T	B.25
0103300000	BFSC M4X9T	A.27
0103300000	BFSC M4X9T	B.30
0103300000	BFSC M4X9T	H.4
0103300000	BFSC M4X9T	I.9
0105060000	SAK 4 OR	I.7
0105100000	AP SAK4-10 DB	I.6
0105160000	AP SAK4-10 OR	I.6
0105360000	AP ASK1 OR	I.6
0105420000	SAKT 1/35/LT	A.32
0105620000	SAKT 1/35/LT STB	A.32
0105720000	SAKT 1/35/QT1	A.33
0105820000	SAKT 1/35/DU1	A.32
0105920000	SAKT 2/35/LT/STB	A.33
0106020000	SAKT 2/35/LT 4STB	A.33
0107160000	SAK 2.5/TC AL	B.34
0107180000	SAK 2.5/TC AL BL	I.7
0107260000	SAK 2.5/TC CH	B.34
0107280000	SAK 2.5/TC CH BL	I.7
0108520000	SAK 2.5 SW 1X1/KRG	I.7
0108560000	SAK 2.5 SW 1X1	I.7
0108560000	SAK 2.5 SW 1X1	B.38
0108960000	AKZ 2.5 K SW U/V 1X1	E.13

0110000000

0110020000	SAK 10 KRG	B.7
0110040000	SAK 10 OR	I.7
0110060000	SAK 10	B.3
0110070000	SAK 10 KRG/BL	I.7
0110070000	SAK 10 KRG/BL	B.7
0110080000	SAK 10 BL	B.3
0110080000	SAK 10 BL	I.7
0114100000	QL 2 SAKB10	B.30
0114300000	QL 3 SAKB10	B.30
0114500000	QL 4 SAKB10	B.30
0117500000	TS 15X5/LL 2M/ST/ZN	H.10
0117510000	TS 15X5/LL 1M/ST/ZN	H.10
0117900000	AP SAK4-10 RT	I.6
0117910000	AP SAK4-10 I	I.6
0117920000	AP SAK4-10 KRG	I.4
0117920000	AP SAK4-10 KRG	I.6
0117920000	AP SAK4-10 KRG	A.7
0117920000	AP SAK4-10 KRG	A.20
0117920000	AP SAK4-10 KRG	B.44
0117920000	AP SAK4-10 KRG	B.7
0117920000	AP SAK4-10 KRG	B.19
0117920000	AP SAK4-10 KRG	B.6
0117920000	AP SAK4-10 KRG	A.8
0117960000	AP SAK4-10	A.38
0117960000	AP SAK4-10	A.37
0117960000	AP SAK4-10	A.3
0117960000	AP SAK4-10	B.3
0117960000	AP SAK4-10	B.37
0117960000	AP SAK4-10	B.44
0117960000	AP SAK4-10	C.2
0117960000	AP SAK4-10	C.3
0117960000	AP SAK4-10	C.4
0117960000	AP SAK4-10	C.5
0117960000	AP SAK4-10	I.6
0117970000	AP SAK4-10 KRG/BL	B.19
0117970000	AP SAK4-10 KRG/BL	A.8
0117970000	AP SAK4-10 KRG/BL	A.7
0117970000	AP SAK4-10 KRG/BL	B.44
0117970000	AP SAK4-10 KRG/BL	B.7
0117970000	AP SAK4-10 KRG/BL	I.6
0117970000	AP SAK4-10 KRG/BL	B.6
0117970000	AP SAK4-10 KRG/BL	A.20
0117980000	AP SAK4-10 BL	C.3
0117980000	AP SAK4-10 BL	C.5
0117980000	AP SAK4-10 BL	C.4
0117980000	AP SAK4-10 BL	C.2
0117980000	AP SAK4-10 BL	I.6
0117980000	AP SAK4-10 BL	B.3
0117980000	AP SAK4-10 BL	I.6
0117980000	AP SAK4-10 BL	A.3

0120000000

0122700000	STB 5.5/D3.7/2.3/M3 ZB	I.15
0122800000	TS 32X15 2M/ST/ZN	H.10
0123600000	QL 2 SAK35	B.8
0123600000	QL 2 SAK35	I.9
0123600000	QL 2 SAK35	C.4
0123600000	QL 2 SAK35	B.5
0123600000	QL 2 SAK35	B.4
0123600000	QL 2 SAK35	A.4
0123600000	QL 2 SAK35	C.5
0123700000	QL 3 SAK35	A.4
0123700000	QL 3 SAK35	B.8
0123700000	QL 3 SAK35	B.4
0123700000	QL 3 SAK35	A.4

Order No.	Type	Page
-----------	------	------

0123700000	QL 3 SAK35	A.5
0123700000	QL 3 SAK35	I.9
0123700000	QL 3 SAK35	B.5
0123800000	QL 4 SAK35	A.4
0123800000	QL 4 SAK35	I.9
0123800000	QL 4 SAK35	C.4
0123800000	QL 4 SAK35	B.5
0123800000	QL 4 SAK35	B.4
0123800000	QL 4 SAK35	B.8
0123800000	QL 4 SAK35	A.5
0124000000	VL 2 SAK35	A.4
0124000000	VL 2 SAK35	B.4
0124000000	VL 2 SAK35	B.5
0124000000	VL 2 SAK35	A.5
0124000000	VL 2 SAK35	I.12
0124000000	VL 2 SAK35	B.8
0124300000	H16,0/15	J.33
0124400000	H25,0/15	J.33
0124620000	SAKT 1/35/QT2	A.33
0124700000	H6,0/15	J.33
0124800000	H10,0/15	J.33
0126600000	SAKH 6 EP/SW	I.7
0126600000	SAKH 6 EP/SW	D.6
0126700000	SAKH 10 EP/SW	I.7
0126700000	SAKH 10 EP/SW	D.7
0128300000	SAK 4 EP/SW	I.7
0128300000	SAK 4 EP/SW	D.6
0128320000	SAK 4 KRG	B.6
0128370000	SAK 4 KRG BL	I.7
0128370000	SAK 4 KRG BL	B.6
0128380000	SAK 4 BL	B.3
0128380000	SAK 4 BL	I.7
0128900000	BFSC M3X22 PA/RT	A.7
0128900000	BFSC M3X22 PA/RT	I.17
0128900000	BFSC M3X22 PA/RT	A.8
0128900000	BFSC M3X22 PA/RT	C.5
0128900000	BFSC M3X22 PA/RT	A.9
0128900000	BFSC M3X22 PA/RT	A.3
0128900000	BFSC M3X22 PA/RT	B.2
0128900000	BFSC M3X22 PA/RT	A.40
0128900000	BFSC M3X22 PA/RT	C.4
0128900000	BFSC M3X22 PA/RT	B.45
0128900000	BFSC M3X22 PA/RT	B.39
0128900000	BFSC M3X22 PA/RT	A.4
0128900000	BFSC M3X22 PA/RT	B.4
0128900000	BFSC M3X22 PA/RT	C.3
0128900000	BFSC M3X22 PA/RT	B.3
0128900000	BFSC M3X22 PA/RT	A.2
0128900000	BFSC M3X22 PA/RT	C.2
0128900000	BFSC M3X22 PA/RT	A.9
0128900000	BFSC M3X22 PA/RT	B.7
0128900000	BFSC M3X22 PA/RT	B.6
0129100000	BFSC M4X32 PA/RT	B.5
0129100000	BFSC M4X32 PA/RT	A.5
0129100000	BFSC M4X32 PA/RT	B.4
0129100000	BFSC M4X32 PA/RT	A.9
0129100000	BFSC M4X32 PA/RT	C.4
0129100000	BFSC M4X32 PA/RT	B.8
0129100000	BFSC M4X32 PA/RT	A.4
0129100000	BFSC M4X32 PA/RT	I.17

0130000000

0130000000	STB 7.5/D6/4/M4 ZB/SAKB	I.15
0130070000		I.10
0130100000	TW SAK4-10 EP/SW	D.6
0130120000	TW SAK4-10 KRG	A.8
0130120000	TW SAK4-10 KRG	B.44
0130120000	TW SAK4-10 KRG	A.20
0130120000	TW SAK4-10 KRG	B.6
0130120000	TW SAK4-10 KRG	A.7
0130120000	TW SAK4-10 KRG	B.7
0130120000	TW SAK4-10 KRG	B.19
0130160000	TW 4 SAK4-10	C.4
0130160000	TW 4 SAK4-10	C.5
0130160000	TW 4 SAK4-10	B.3
0130160000	TW 4 SAK4-10	B.6
0130160000	TW 4 SAK4-10	A.20
0130160000	TW 4 SAK4-10	C.3
0130160000	TW 4 SAK4-10	C.2
0130160000	TW 4 SAK4-10	A.37
0130160000	TW 4 SAK4-10	A.36
0130160000	TW 4 SAK4-10	B.44
0130160000	TW 4 SAK4-10	A.3
0130160000	TW 4 SAK4-10	C.3
0130160000	TW 4 SAK4-10	A.8
0130170000	TW SAK4-10 KRG/BL	A.7
0130170000	TW SAK4-10 KRG/BL	A.20
0130170000	TW SAK4-10 KRG/BL	B.19
0130170000	TW SAK4-10 KRG/BL	B.6
0130170000	TW SAK4-10 KRG/BL	B.7
0130170000	TW SAK4-10 KRG/BL	B.44
0130180000	TW 4 SAK4-10 BL	C.5
0130180000	TW 4 SAK4-10 BL	C.4
0130180000	TW 4 SAK4-10 BL	C.3
0130180000	TW 4 SAK4-10 BL	A.3
0130180000	TW 4 SAK4-10 BL	C.2
0130180000	TW 4 SAK4-10 BL	B.3
0130200000	STB 6/D3.9/2.3/M2.5 ZB	B.6
0130200000	STB 6/D3.9/2.3/M2.5 ZB	I.15
0130600000	QL 2 SAK4	A.38

Order No.	Type	Page
-----------	------	------

0130600000	QL 2 SAK4	B.44
0130600000	QL 2 SAK4	B.37
0130600000	QL 2 SAK4	A.37
0130600000	QL 2 SAK4	I.10
0130700000	QL 3 SAK4	A.37
0130700000	QL 3 SAK4	I.9
0130700000	QL 3 SAK4	B.5
0130700000	QL 3 SAK4	B.4
0130700000	QL 3 SAK4	B.8
0130700000	QL 3 SAK4	A.5
0130800000	QL 4 SAK4	A.4
0130800000	QL 4 SAK4	B.4
0130800000	QL 4 SAK4	B.37
0130800000	QL 4 SAK4	A.38
0130800000	QL 4 SAK4	I.10
0130800000	QL 4 SAK4	I.9
0131700000	AP SAKH6/10 EP/SW	D.7
0131700000	AP SAKH6/10 EP/SW	I.6
0131700000	AP SAKH6/10 EP/SW	D.6
0131720000	AP SAKH6/10 KRG	I.6
0131730000	AP SAKH6/10 KRS	I.4
0132600010	DEK 5 FW 10-500	K.7
0132961021	DEK 5 GS A	K.7
0132961022	DEK 5 GS B	K.7
0132961023	DEK 5 GS C	K.7
0132961024	DEK 5 GS D	K.7
0132961025	DEK 5 GS E	K.7
0132961026	DEK 5 GS F	K.7
0132961027	DEK 5 GS G	K.7
0132961028	DEK 5 GS H	K.7
0132961029	DEK 5 GS I	K.7
0132961030	DEK 5 GS J	K.7
0132961031	DEK 5 GS K	K.7
0132961032	DEK 5 GS L	K.7
0132961033	DEK 5 GS M	K.7
0132961034	DEK 5 GS N	K.7
0132961035	DEK 5 GS O	K.7
0132961036	DEK 5 GS P	K.7
0132961037	DEK 5 GS Q	K.7
0132961038	DEK 5 GS R	K.7
0132961039	DEK 5 GS S	K.7
0132961040	DEK 5 GS T	K.7
0132961041	DEK 5 GS U	K.7
0132961042	DEK 5 GS V	K.7
0132961043	DEK 5 GS W	K.7
0132961044	DEK 5 GS X	K.7
0132961045	DEK 5 GS Y	K.7
0132961046	DEK 5 GS Z	K.7
0133161114	DEK 5 FW U1-PE1	K.7
0133161115	DEK 5 FW U2-PE2	K.7
0133161116	DEK 5 FW U3-PE3	K.7
0133161117	DEK 5 FW U4-PE4	K.7
0133161118	DEK 5 FW U5-PE5	K.7
0133161119	DEK 5 FW U6-PE6	K.7
0133161120	DEK 5 FW U7-PE7	K.7
0133161121	DEK 5 FW U8-PE8	K.7
0133161122	DEK 5 FW U9-PE9	K.7
0133261150	DEK 5 FW X1-Z1	K.7
0133261151	DEK 5 FW X2-Z2	K.7
0133261152	DEK 5 FW X3-Z3	K.7
0133261153	DEK 5 FW X4-Z4	K.7
0133261154	DEK 5 FW X5-Z5	K.7
0133261155	DEK 5 FW X6-Z6	K.7
0133261156	DEK 5 FW X7-Z7	K.7
0133261157	DEK 5 FW X8-Z8	K.7

Order No.	Type	Page	Order No.	Type	Page	Order No.	Type	Page	Order No.	Type	Page
0151400000	TW SAKG28 HP/DBR/2	A.43	0170520000	SAKG 40 II	B.51	0180400000	PS 2.3 RT	B.10	0193280000	SAK 6N BL	I.7
0151400000	TW SAKG28 HP/DBR/2	B.50	0170620000	SAKG 46 II	B.52	0180400000	PS 2.3 RT	B.17	0193280000	SAK 6N BL	B.3
0155900000	QL 2 SAK2.5	A.33	0170720000	SAKG 54 II	B.53	0180400000	PS 2.3 RT	A.7	0193400000		I.10
0155900000	QL 2 SAK2.5	I.9	0170820000	SAKG 28 III	B.48	0180400000	PS 2.3 RT	E.13	0194000000	QL 2 SAKG32+70	A.44
0155900000	QL 2 SAK2.5	B.32	0172160000	SAKR/35	A.18	0180400000	PS 2.3 RT	C.5	0194000000	QL 2 SAKG32+70	B.48
0155900000	QL 2 SAK2.5	I.10	0172180000	SAKR/35 BL	I.7	0180400000	PS 2.3 RT	B.11	0194000000	QL 2 SAKG32+70	B.49
0156000000	QL 3 SAK2.5	B.32	0172180000	SAKR/35 BL	A.18	0180400000	PS 2.3 RT	E.10	0194000000	QL 2 SAKG32+70	B.50
0156000000	QL 3 SAK2.5	I.10	0172190000	SAKR/35 WS	I.7	0180400000	PS 2.3 RT	C.4	0194000000	QL 2 SAKG32+70	A.43
0156000000	QL 3 SAK2.5	I.9	0177100000	TW SAKG46 HP/DBR/2	B.52	0180400000	PS 2.3 RT	E.12	0194000000	QL 2 SAKG32+70	A.42
0156000000	QL 3 SAK2.5	A.33	0177100000	TW SAKG46 HP/DBR/2	A.42	0180500000	EP 1 SAKG32/35 HP/DBR	A.44	0194100000	QL 2 SAKG40	B.50
0156100000	QL 4 SAK2.5	I.9	0177100000	TW SAKG46 HP/DBR/2	B.49	0180500000	EP 1 SAKG32/35 HP/DBR	B.49	0194100000	QL 2 SAKG40	B.51
0156100000	QL 4 SAK2.5	A.33	0177100000	TW SAKG46 HP/DBR/2	A.43	0180500000	EP 1 SAKG32/35 HP/DBR	A.43	0194300000	QL 2 SAK6N	A.32
0156100000	QL 4 SAK2.5	B.32	0177100000	TW SAKG46 HP/DBR/2	A.47	0180500000	EP 1 SAKG32/35 HP/DBR	I.4	0194300000	QL 2 SAK6N	I.9
0156100000	QL 4 SAK2.5	I.10	0177100000	TW SAKG46 HP/DBR/2	B.53	0180600000	EP 1 SAKG32/35 HP/TF/GE	I.4	0194300000	QL 2 SAK6N	I.10
0157261187	DEK 5 GS PE	K.7	0177100000	TW SAKG46 HP/DBR/2	A.44	0180600000	EP 1 SAKG32/35 HP/TF/GE	A.44	0194300000	QL 2 SAK6N	A.11
0157261202	DEK 5 GS ERDE	K.7	0177100000	TW SAKG46 HP/DBR/2	B.48	0180600000	EP 1 SAKG32/35 HP/TF/GE	A.43	0194300000	QL 2 SAK6N	A.33
0157261203	DEK 5 GS ERDE IM KREIS	K.7	0177100000	TW SAKG46 HP/DBR/2	B.50	0180600000	EP 1 SAKG32/35 HP/TF/GE	B.49	0194300000	QL 2 SAK6N	B.32
0158760000	AKZ 4 SF SE 6.3/2.8	E.9	0177100000	TW SAKG46 HP/DBR/2	A.46	0180700000	EP 2 SAKG46/35 HP/DBR	A.47	0194300000	QL 2 SAK6N	B.28
			0177100000	TW SAKG46 HP/DBR/2	B.51	0180700000	EP 2 SAKG46/35 HP/DBR	A.46	0194300000	QL 2 SAK6N	I.21
			0177100000	TW SAKG46 HP/DBR/2	A.45	0180700000	EP 2 SAKG46/35 HP/DBR	A.45	0194300000	QL 2 SAK6N	B.31
			0177800000	AP SAK4-10 KRG/DB	I.6	0180700000	EP 2 SAKG46/35 HP/DBR	A.44	0194400000	QL 3 SAK6N	I.10
			0178100000	TSTW 5/M5	H.14	0180700000	EP 2 SAKG46/35 HP/DBR	I.4	0194400000	QL 3 SAK6N	B.28
			0178220000	SAKS 4/35 USA	A.27	0180700000	EP 2 SAKG46/35 HP/DBR	A.42	0194400000	QL 3 SAK6N	A.32
			0178500000	AD 3 SAK10	I.17	0180700000	EP 2 SAKG46/35 HP/DBR	A.43	0194400000	QL 3 SAK6N	I.21
			0178600000	AD 4 SAK10	C.3	0180800000	EP 2 SAKG46/35 HP/TF/GE	A.44	0194400000	QL 3 SAK6N	A.33
			0178600000	AD 4 SAK10	I.17	0180800000	EP 2 SAKG46/35 HP/TF/GE	A.47	0194400000	QL 3 SAK6N	B.32
			0178600000	AD 4 SAK10	B.7	0180800000	EP 2 SAKG46/35 HP/TF/GE	A.45	0194400000	QL 3 SAK6N	A.11
			0178600000	AD 4 SAK10	A.8	0180800000	EP 2 SAKG46/35 HP/TF/GE	A.46	0194400000	QL 3 SAK6N	I.9
			0178600000	AD 4 SAK10	A.3	0180800000	EP 2 SAKG46/35 HP/TF/GE	I.4	0194400000	QL 3 SAK6N	B.31
			0178600000	AD 4 SAK10	B.3	0180800000	EP 2 SAKG46/35 HP/TF/GE	A.43	0194500000	QL 4 SAK6N	A.11
			0178700000	AD 4 SAK35	C.4	0180800000	EP 2 SAKG46/35 HP/TF/GE	A.42	0194500000	QL 4 SAK6N	I.9
			0178700000	AD 4 SAK35	I.17	0181800000	BAL 2	J.11	0194500000	QL 4 SAK6N	A.33
			0178700000	AD 4 SAK35	A.9	0182000000	EP 2/BW SAKG46/35 HP/DBR	I.5	0194500000	QL 4 SAK6N	B.28
			0178700000	AD 4 SAK35	B.5	0183380000	SAKR/35 2STB BL	I.7	0194500000	QL 4 SAK6N	B.32
			0178700000	AD 4 SAK35	A.5	0185020000	SAKG 28 II/GW	B.47	0194500000	QL 4 SAK6N	I.21
			0178700000	AD 4 SAK35	B.4	0185120000	SAKG 32 II/GW	B.49	0194500000	QL 4 SAK6N	B.31
			0178700000	AD 4 SAK35	A.8	0185220000	SAKG 40 II/GW	B.51	0194500000	QL 4 SAK6N	A.32
			0179900000	TW SAKG46 HP/TF/GE/2	B.52	0185320000	SAKG 46 II/GW	B.52	0194500000	QL 4 SAK6N	I.10
			0179900000	TW SAKG46 HP/TF/GE/2	A.42	0185420000	SAKG 54 II/GW	B.53	0194700000	VL 2 SAKGN/SAKT	A.8
			0179900000	TW SAKG46 HP/TF/GE/2	A.45	0185760000	SAKRD/35	A.18	0194700000	VL 2 SAKGN/SAKT	A.3
			0179900000	TW SAKG46 HP/TF/GE/2	B.49	0186100000	H2.5/12	J.33	0194700000	VL 2 SAKGN/SAKT	C.3
			0179900000	TW SAKG46 HP/TF/GE/2	B.48	0186500000	H1.5/10	J.33	0194700000	VL 2 SAKGN/SAKT	B.7
			0179900000	TW SAKG46 HP/TF/GE/2	A.44	0189860000	SAK 2.5/TC CO	B.34	0194700000	VL 2 SAKGN/SAKT	B.28
			0179900000	TW SAKG46 HP/TF/GE/2	B.53	0189960000	SAK 2.5/TC CU	B.34	0194700000	VL 2 SAKGN/SAKT	I.12
			0179900000	TW SAKG46 HP/TF/GE/2	B.50				0194700000	VL 2 SAKGN/SAKT	A.11
			0179900000	TW SAKG46 HP/TF/GE/2	A.47				0195620000	SAKT 1/DU1	B.31
			0179900000	TW SAKG46 HP/TF/GE/2	B.51				0196600000	AD 4 SAK6N	A.8
			0179900000	TW SAKG46 HP/TF/GE/2	A.46				0196600000	AD 4 SAK6N	B.3
			0179900000	TW SAKG46 HP/TF/GE/2	A.43				0196600000	AD 4 SAK6N	C.3

0160000000

0162220000	SAKS 4 USA	B.25
0162520000	AP AK2.5	I.6
0162520000	AP AK2.5	E.12
0162570000	AP AK2.5 KRG/BL	E.12
0162570000	AP AK2.5 KRG/BL	I.6
0164000000	TSTW 6/M6	H.14
0164400000	SS M3 D 128-A 3	B.28
0164400000	SS M3 D 128-A 3	A.11
0164400000	SS M3 D 128-A 3	I.10
0164600000	TW SAKG28 HP/TF/GE/2	A.43
0164600000	TW SAKG28 HP/TF/GE/2	A.44
0164600000	TW SAKG28 HP/TF/GE/2	B.47
0164600000	TW SAKG28 HP/TF/GE/2	B.50
0164600000	TW SAKG28 HP/TF/GE/2	B.46
0164600000	TW SAKG28 HP/TF/GE/2	B.48
0164600000	TW SAKG28 HP/TF/GE/2	B.49
0165860000	STA 2.5/2	B.43
0165860000	STA 2.5/2	A.36
0165860000	STA 2.5/2	A.37
0165860000	STA 2.5/2	B.42
0165860000	STA 2.5/2	B.36
0165860000	STA 2.5/3	A.37
0165860000	STA 2.5/3	B.36
0165860000	STA 2.5/3	B.42
0165860000	STA 2.5/3	B.43
0165860000	STA 2.5/3	A.36
0166060000	STA 2.5/5	B.42
0166060000	STA 2.5/5	B.43
0166060000	STA 2.5/5	B.36
0166060000	STA 2.5/5	A.36
0166060000	STA 2.5/5	A.37
0166160000	STA 2.5/8	B.42
0166160000	STA 2.5/8	A.36
0166160000	STA 2.5/8	B.36
0166160000	STA 2.5/8	B.43
0166160000	STA 2.5/8	A.37
0166160000	STA 2.5/8	E.10
0166800000	TW AKZ4 HP/DBR/0.5	I.9
0167000000	QL 3 SAK70	B.9
0167000000	QL 3 SAK70	A.6
0168600000	STB 14/D5/2.3/M3 SAK2.5	A.11
0168600000	STB 14/D5/2.3/M3 SAK2.5	B.3
0168600000	STB 14/D5/2.3/M3 SAK2.5	B.28
0168600000	STB 14/D5/2.3/M3 SAK2.5	B.42
0168600000	STB 14/D5/2.3/M3 SAK2.5	B.43
0168600000	STB 14/D5/2.3/M3 SAK2.5	I.15
0168600000	STB 14/D5/2.3/M3 SAK2.5	B.6
0168600000	STB 14/D5/2.3/M3 SAK2.5	D.6
0168600000	STB 14/D5/2.3/M3 SAK2.5	C.5
0168600000	STB 14/D5/2.3/M3 SAK2.5	A.36
0168600000	STB 14/D5/2.3/M3 SAK2.5	A.37
0168600000	STB 14/D5/2.3/M3 SAK2.5	B.36
0168600000	STB 14/D5/2.3/M3 SAK2.5	A.7
0168600000	STB 14/D5/2.3/M3 SAK2.5	A.3
0168600000	STB 14/D5/2.3/M3 SAK2.5	C.4
0168600000	STB 14/D5/2.3/M3 SAK2.5	C.2
0168800000	SAK 4 CUN/EP/SW	D.6
0169300000	TS 32X15 2M/AL/BK	H.10
0169900000	STB 14/D6/4/M3 SAK10	B.32
0169900000	STB 14/D6/4/M3 SAK10	A.3
0169900000	STB 14/D6/4/M3 SAK10	A.9
0169900000	STB 14/D6/4/M3 SAK10	B.3
0169900000	STB 14/D6/4/M3 SAK10	B.7
0169900000	STB 14/D6/4/M3 SAK10	B.4
0169900000	STB 14/D6/4/M3 SAK10	A.33
0169900000	STB 14/D6/4/M3 SAK10	A.8
0169900000	STB 14/D6/4/M3 SAK10	I.20
0169900000	STB 14/D6/4/M3 SAK10	A.4
0169900000	STB 14/D6/4/M3 SAK10	A.32
0169900000	STB 14/D6/4/M3 SAK10	C.3
0169900000	STB 14/D6/4/M3 SAK10	B.28
0169900000	STB 14/D6/4/M3 SAK10	I.15
0169900000	STB 14/D6/4/M3 SAK10	B.31

0170000000

0170020000	SAKG 28 I	B.46
0170320000	SAKG 28 II	B.47
0170420000	SAKG 32 II	B.49

0180000000

0180400000	PS 2.3 RT	E.3
0180400000	PS 2.3 RT	A.2
0180400000	PS 2.3 RT	B.36
0180400000	PS 2.3 RT	B.43
0180400000	PS 2.3 RT	A.37
0180400000	PS 2.3 RT	E.10
0180400000	PS 2.3 RT	I.9
0180400000	PS 2.3 RT	B.9
0180400000	PS 2.3 RT	A.6
0180400000	PS 2.3 RT	A.11
0180400000	PS 2.3 RT	B.3
0180400000	PS 2.3 RT	B.28
0180400000	PS 2.3 RT	B.42
0180400000	PS 2.3 RT	B.43
0180400000	PS 2.3 RT	I.15
0180400000	PS 2.3 RT	B.6
0180400000	PS 2.3 RT	D.6
0180400000	PS 2.3 RT	C.5
0180400000	PS 2.3 RT	A.36
0180400000	PS 2.3 RT	A.37

Order No.	Type	Page	Order No.	Type	Page	Order No.	Type	Page	Order No.	Type	Page
0205200000	EP 1 SAKG28/32 HP/TF/GE	I.4	0212880000	SAK 6/EN BL	C.3	0245800000	BSTO 28/12 MK	F.6	0267100000	BFSC M4X30	A.5
0205300000	EP 2 SAKG46/32 HP/DBR	B.52	0213200000	SAKE 70/32	B.15	0245900000	BSTB 28/12 MK U 1-12	F.6	0267100000	BFSC M4X30	I.10
0205300000	EP 2 SAKG46/32 HP/DBR	B.51	0214020000	SAKS 1/35 G20 LD 48VAC	A.24	0245900000	BSTB 28/12 MK U 1-12	F.2	0267100000	BFSC M4X30	H.4
0205300000	EP 2 SAKG46/32 HP/DBR	B.49	0215560000	SAKD 2.5N	B.2	0247000000	QL 2 SAKG46	A.47	0267100000	BFSC M4X30	B.5
0205300000	EP 2 SAKG46/32 HP/DBR	B.48	0215580000	SAKD 2.5N BL	B.2	0247000000	QL 2 SAKG46	B.52	0267100000	BFSC M4X30	A.4
0205300000	EP 2 SAKG46/32 HP/DBR	B.53	0215580000	SAKD 2.5N BL	I.7	0247000000	QL 2 SAKG46	A.46	0267100000	BFSC M4X30	B.9
0205300000	EP 2 SAKG46/32 HP/DBR	I.4	0215700000	STB 8.5/D4/2.3/M2.5 AKZ	A.2	0247400000	QL 4 SAKG54	B.53	0267100000	BFSC M4X30	B.4
0205300000	EP 2 SAKG46/32 HP/DBR	B.50	0215700000	STB 8.5/D4/2.3/M2.5 AKZ	B.2	0247400000	QL 4 SAKG54	A.47	0267200000	STB 25 IH/GE	I.20
0205400000	EP 2 SAKG46/32 HP/TF/GE	B.50	0215700000	STB 8.5/D4/2.3/M2.5 AKZ	A.13	0248500000	VH 13.5/4.9/3.3 SAK4	A.11	0267200000	STB 25 IH/GE	I.15
0205400000	EP 2 SAKG46/32 HP/TF/GE	B.49	0215700000	STB 8.5/D4/2.3/M2.5 AKZ	B.11	0248500000	VH 13.5/4.9/3.3 SAK4	I.9	0267400000	QL 2 RSF1+2	B.29
0205400000	EP 2 SAKG46/32 HP/TF/GE	B.51	0215700000	STB 8.5/D4/2.3/M2.5 AKZ	B.10	0248500000	VH 13.5/4.9/3.3 SAK4	I.10	0267400000	QL 2 RSF1+2	B.28
0205400000	EP 2 SAKG46/32 HP/TF/GE	B.52	0215700000	STB 8.5/D4/2.3/M2.5 AKZ	B.59	0248500000	VH 13.5/4.9/3.3 SAK4	B.28	0267500000	QL 3 RSF1+2	B.28
0205400000	EP 2 SAKG46/32 HP/TF/GE	B.48	0215700000	STB 8.5/D4/2.3/M2.5 AKZ	E.9	0248920000	SAKS 3 GZ/6.3K32	B.23	0267500000	QL 3 RSF1+2	B.29
0205400000	EP 2 SAKG46/32 HP/TF/GE	B.53	0215700000	STB 8.5/D4/2.3/M2.5 AKZ	A.53	0249000000	VH 12/4.9/3.3 SAK6N	B.32	0267600000	QL 4 RSF1+2	B.29
0205400000	EP 2 SAKG46/32 HP/TF/GE	I.4	0215700000	STB 8.5/D4/2.3/M2.5 AKZ	E.10	0249000000	VH 12/4.9/3.3 SAK6N	B.31	0267600000	QL 4 RSF1+2	B.28
0205700000	QB 2 SAKT1	I.21	0215700000	STB 8.5/D4/2.3/M2.5 AKZ	B.60	0249000000	VH 12/4.9/3.3 SAK6N	I.10	0268860000	SAKD 2.5/35	A.2
0205800000	QB 3 SAKT1	I.21	0215700000	STB 8.5/D4/2.3/M2.5 AKZ	I.15	0249000000	VH 12/4.9/3.3 SAK6N	A.32	0268880000	SAKD 2.5/35 BL	I.7
0205900000	QB 4 SAKT1	I.21	0215700000	STB 8.5/D4/2.3/M2.5 AKZ	A.52	0249000000	VH 12/4.9/3.3 SAK6N	I.21	0268880000	SAKD 2.5/35 BL	A.2
0206160000	EWK 1	H.13	0215700000	STB 8.5/D4/2.3/M2.5 AKZ	E.3	0249000000	VH 12/4.9/3.3 SAK6N	I.9	0269120000	SAKT 1/LT	B.31
0206160000	EWK 1	B.62	0215700000	STB 8.5/D4/2.3/M2.5 AKZ	A.39	0249000000	VH 12/4.9/3.3 SAK6N	A.33	0269320000	SAKT 1/QT1	B.31
0206160000	EWK 1	C.8	0215700000	STB 8.5/D4/2.3/M2.5 AKZ	A.50	0249000000	VH 12/4.9/3.3 SAK6N	I.9			
0206820000	SAKS 2	B.24	0215700000	STB 8.5/D4/2.3/M2.5 AKZ	A.51	0249100000	KMVF L 6.3 EP/SW	D.8			
0207400000	QL 2 SAK6N-SAK35	I.10	0215700000	STB 8.5/D4/2.3/M2.5 AKZ	A.38	0249200000	KMVF RE 6.3 EP/SW	D.8			
0207530000	DS 14 SAK4	I.12	0215700000	STB 8.5/D4/2.3/M2.5 AKZ	E.11	0249300000	KMVT L 2.4 EP/SW	D.9	0270100000	TS 35X15/2.3 2M/QU/BK	H.11
0207630000	DS 12.5 SAK10	I.12	0215700000	STB 8.5/D4/2.3/M2.5 AKZ	B.38	0249400000	KMVT RE 2.4 EP/SW	D.9	0270320000	RSF 1 KRG	B.28
0207730000	DS 12.5 SAK6N	I.12	0215700000	STB 8.5/D4/2.3/M2.5 AKZ	B.37	0249600000	ZS 2.3/4	I.14	0270420000	AP RSF1 KRG	I.6
0207800000	QL 2 SAKS2	A.26	0215700000	STB 8.5/D4/2.3/M2.5 AKZ	A.54				0270460000	AP RSF3	I.6
0207800000	QL 2 SAKS2	I.9	0215700000	STB 8.5/D4/2.3/M2.5 AKZ	E.12				0270460000	AP RSF3	A.11
0207800000	QL 2 SAKS2	B.25	0215700000	STB 8.5/D4/2.3/M2.5 AKZ	A.56				0270460000	AP RSF3	B.28
0207800000	QL 2 SAKS2	A.27	0215700000	STB 8.5/D4/2.3/M2.5 AKZ	E.2				0270760000	QS 2/12/4	I.13
0207800000	QL 2 SAKS2	B.24	0215700000	STB 8.5/D4/2.3/M2.5 AKZ	E.8	0257120000	TW SAK2.5-35/32 KRG	B.30	0270760000	QS 2/12/4	I.21
0207900000	QL 3 SAKS2	A.26	0215700000	STB 8.5/D4/2.3/M2.5 AKZ	E.13	0258260000	HP 7 TSK31.5	I.16	0270860000	QS 2/10/4	I.13
0207900000	QL 3 SAKS2	B.24	0215700000	STB 8.5/D4/2.3/M2.5 AKZ	B.61	0258360000	HP 8 ADP 1	I.16	0270860000	QS 2/10/4	I.21
0207900000	QL 3 SAKS2	A.27	0215700000	STB 8.5/D4/2.3/M2.5 AKZ	B.56	0258660000	EW 35/SCHA/M3	I.12	0270960000	QS 2/8/4	A.32
0207900000	QL 3 SAKS2	B.25	0215700000	STB 8.5/D4/2.3/M2.5 AKZ	B.57	0258760000	EWK 2/SCHA/M3/L	I.12	0270960000	QS 2/8/4	A.33
0207900000	QL 3 SAKS2	I.9	0215700000	STB 8.5/D4/2.3/M2.5 AKZ	B.58	0259800000	SSCH 10X3X1000 MS/BK	H.3	0270960000	QS 2/8/4	I.13
0208000000	QL 4 SAKS2	A.27	0215700000	STB 8.5/D4/2.3/M2.5 AKZ	A.12				0270960000	QS 2/8/4	B.32
0208000000	QL 4 SAKS2	A.26	0215700000	STB 8.5/D4/2.3/M2.5 AKZ	A.55				0270960000	QS 2/8/4	B.31
0208000000	QL 4 SAKS2	I.9	0217160000	DK 4SS/35 FF 4X6.3/2.8	A.38				0270960000	QS 2/8/4	I.21
0208000000	QL 4 SAKS2	B.24	0217900000	TS 15X5/L2 2M/AL/B	H.10	0261100000	AD 4 WSD SAKG54 HP/DBR	I.17	0271020000	SAK 16 KRG	B.7
0208000000	QL 4 SAKS2	B.25	0218660000	SAK 2.5/EN	C.2	0262100000	BSTO 28/16 MK 4/16	F.3	0271060000	SAK 16	I.6
0208500000	E 16/10A RT TNDZ	A.26	0218680000	SAK 2.5/EN BL	I.7	0262200000	BSTB 28/16 MK U 1-16	F.3	0271080000	SAK 16 BL	B.4
0208500000	E 16/10A RT TNDZ	B.24	0218680000	SAK 2.5/EN BL	C.2	0263100000	AD 4 WSD SAKG28 HP/DBR	I.17	0271080000	SAK 16 BL	B.4
0208500000	E 16/10A RT TNDZ	A.28				0263200000	AD 4 WSD SAKG40 HP/DBR	I.17	0271120000	AP SAK16 KRG	I.6
0208500000	E 16/10A RT TNDZ	B.26				0263300000	AD 4 WSD SAKG46 HP/DBR	I.17	0271120000	AP SAK16 KRG	B.7
0208600000	E 16/16A GR TNDZ	A.28				0263500000	QL 3 SAKG40	B.50	0271120000	AP SAK16 KRG	A.9
0208600000	E 16/16A GR TNDZ	A.26	0220500000	QL 5 SAK6N	I.21	0263500000	QL 3 SAKG40	B.51	0271120000	AP SAK16 KRG	I.4
0208600000	E 16/16A GR TNDZ	B.26	0220600000	QL 6 SAK6N	I.21	0264400000	QL 2 SAKG54	A.47	0271160000	AP SAK16	I.6
0208600000	E 16/16A GR TNDZ	B.24	0221200000	QL 15 SAK6N	I.21	0264400000	QL 2 SAKG54	B.53	0271160000	AP SAK16	I.4
0208700000	E 16/20A BL TNDZ	B.24	0222760000	ASK 1/EN LD 15K 24VDC	C.7	0264900000	AD 3 WSD SAKG54 HP/DBR	I.17	0271160000	AP SAK16	B.4
0208700000	E 16/20A BL TNDZ	A.28	0222860000	ASK 1/EN LD 1D 24VAC	C.7	0265800000	G 25/1.00A/M RT	B.26	0271160000	AP SAK16	A.4
0208700000	E 16/20A BL TNDZ	A.26	02225260000	ASK 1/EN LD 27K 48VDC	C.7	0265800000	G 25/1.00A/M RT	A.28	0271160000	AP SAK16	C.3
0208700000	E 16/20A BL TNDZ	B.26	0225360000	ASK 1/EN LD 1D 48VAC	C.7	0266320000	AST 1 6.3 KRG	B.42	0271180000	AP SAK16 BL	C.3
0208800000	E 16/25A GE TNDZ	B.24	0225460000	ASK 1/EN LD 56K 115VDC	C.7	0266360000	AST 1 6.3	B.36	0271180000	AP SAK16 BL	I.6
0208800000	E 16/25A GE TNDZ	A.26	0225560000	ASK 1/EN LD 1D 115VAC	C.7	0266400000	AP AST1+5 DB	B.36	0271180000	AP SAK16 BL	A.4
0208800000	E 16/25A GE TNDZ	B.26	0225660000	ASK 1/EN LD 120K 230VDC	C.7	0266400000	AP AST1+5 DB	A.37	0271180000	AP SAK16 BL	B.4
0208800000	E 16/25A GE TNDZ	A.28	0225760000	ASK 1/EN LD 1D 230VAC	C.7	0266400000	AP AST1+5 DB	A.36	0271200000	STB 25 IH/GN	I.20
0208900000	P 16/10 RT SAKS2	B.24	0225820000	SAKS 1/35 G20 LD 24VDC	A.24	0266400000	AP AST1+5 DB	I.6	0271200000	STB 25 IH/GN	I.15
0208900000	P 16/10 RT SAKS2	B.27	0226460000	ASK 1/EN LD 33K 60VDC	C.7	0266420000	AP AST1+5 KRG	I.6	0271300000	STB 25 IH/GR	I.20
0208900000	P 16/10 RT SAKS2	A.29				0266420000	AP AST1+5 KRG	I.4	0271300000	STB 25 IH/GR	I.15
0208900000	P 16/10 RT SAKS2	A.26				0266420000	AP AST1+5 KRG	B.43	0271400000	STB 25 IH/GR	I.15
0209000000	P 16/16 GR SAKS2	A.26				0266420000	AP AST1+5 KRG	B.42	0271400000	STB 25 IH/GR	I.20
0209000000	P 16/16 GR SAKS2	A.29				0266460000	AP AST1+5	I.6	0271500000	STB 25 IH/SW	I.15
0209000000	P 16/16 GR SAKS2	B.24	0235000000	IS 8 DIN 6911	J.20	0266500000	ZB 35/M6X16	A.30	0271500000	STB 25 IH/SW	I.20
0209000000	P 16/20 BL SAKS2	B.27	0235860000	DEK 5 FWZ 1,3,5-19	K.7	0266500000	ZB 35/M6X16	A.31	0271800000	EP 1/BW SAKG28/32 HP/DB	I.5
0209100000	P 16/20 BL SAKS2	B.27	0235960000	DEK 5 FWZ 21,23,25-39	K.7	0266500000	ZB 35/M6X16	H.6	0271900000	EP 2/BW SAKG46/32 HP/DB	I.5
0209100000	P 16/20 BL SAKS2	B.24	0236060000	DEK 5 FWZ 41,43,45-59	K.7	0266500000	ZB 35/M6X16	I.10	0273400000	AD 3 SAK35	B.4
0209100000	P 16/20 BL SAKS2	A.26	0236160000	DEK 5 FWZ 2,4,6-20	K.7	0266700000	VH 8/4.9/3.3 SAK2.5	B.32	0273400000	AD 3 SAK35	I.17
0209100000	P 16/20 BL SAKS2	A.29	0236260000	DEK 5 FWZ 22,24,26-40	K.7	0266700000	VH 8/4.9/3.3 SAK2.5	A.33	0273820000	MK 3/2	F.2
0209100000	P 16/20 BL SAKS2	B.24	0236360000	DEK 5 FWZ 42,44,46-60	K.7	0266700000	VH 8/4.9/3.3 SAK2.5	I.9	0273920000	MK 3/3	F.2
			0236400000	TS 35X15 2M/ST/ZN	H.11	0266700000	VH 8/4.9/3.3 SAK2.5	E.12	0274020000	MK 3/4	F.2
			0236500000	TS 35X15/L1 2M/ST/ZN	H.11	0266800000	BFSC M2.5X14 SAKD2.5N	A.56	0274200000	MK 3/3	F.2
			0236510000	TS 35X15/L1 1M/ST/ZN	B.36	0266800000	BFSC M2.5X14 SAKD2.5N	A.55	0274220000	MK 3/6	F.2
			0236760000	AST 3 6.3		0266800000	BFSC M2.5X14 SAKD2.5N	E.11	0274320000	MK 3/7	F.2
						0266800000	BFSC M2.5X14 SAKD2.5N	E.10	0274420000	MK 3/8	F.2
						0266800000	BFSC M2.5X14 SAKD2.5N	A.53	0274520000	MK 3/9	F.2
						0266800000	BFSC M2.5X14 SAKD2.5N	B.56	0274620000	MK 3/10	F.2
						0266800000	BFSC M2.5X14 SAKD2.5N	B.59	0278500000	BSTB 28/16/6,35 O 1-12	F.2
						0266800000	BFSC M2.5X14 SAKD2.5N	B.58	0278700000	BSTB 28/16 MK O 1-16	F.3
						0266800000	BFSC M2.5X14 SAKD2.5N	A.52	0279500000	AP SAK2.5 GE	I.6
						0266800000	BFSC M2.5X14 SAKD2.5N	A.51	0279520000	AP SAK2.5 KRG	I.6
						0266800000	BFSC M2.5X14 SAKD2.5N	A.50	0279520000	AP SAK2.5 KRG	B.6
						0266800000	BFSC M2.5X14 SAKD2.5N	B.57	027		

Order No.	Type	Page	Order No.	Type	Page	Order No.	Type	Page	Order No.	Type	Page
0279580000	AP SAK2.5 BL	A.40	0294460000	AP AKZ4	E.8	0302860000	TW SAK2.5	B.39	0310000000		
0279620000	SAK 2.5 KRG	B.6	0294460000	AP AKZ4	E.9	0302860000	TW SAK2.5	B.38	0310020000	PS 2.0 MC	I.14
0279660000	SAK 2.5	B.2	0294460000	AP AKZ4	I.4	0302860000	TW SAK2.5	B.34	0310320000	SAKT 4/LT STB2.0	B.32
0279670000	SAK 2.5 KRG/BL	I.7	0294460000	AP AKZ4	E.11	0302860000	TW SAK2.5	B.2	0316500000	ZB 4	H.6
0279670000	SAK 2.5 KRG/BL	B.6	0294460000	AP AKZ4	E.13	0302860000	TW SAK2.5	B.6	0316500000	ZB 4	A.30
0279680000	SAK 2.5 BL	I.7	0294460000	AP AKZ4	E.12	0302870000	TW SAK2.5 KRG/BL	A.7	0316500000	ZB 4	A.31
0279680000	SAK 2.5 BL	B.2	0294460000	AP AKZ4	E.10	0302870000	TW SAK2.5 KRG/BL	A.2	0316600000	ZB 16 ZKSC	A.30
0280000000			0294460000	AP AKZ4	E.3	0302880000	TW SAK2.5 BL	C.2	0316600000	ZB 16 ZKSC	A.31
0280100000	DKSUE NSCH/ESCH	H.3	0294480000	AP AKZ4 BL	I.6	0302880000	TW SAK2.5 BL	B.2	0316600000	ZB 16 ZKSC	H.6
0280200000	NSCH 1M	H.3	0294480000	AP AKZ4 BL	E.3	0302880000	TW SAK2.5 BL	B.39	0317000000	H25,0/30 BR	J.22
0280300000	ESCH 1 M	H.3	0294500000	GZ 2.0A	B.26	0303000000	KISC M3X20.5/10 EK4	D.3	0317100000	H25,0/36 BR	J.22
0280600000	STB 8.5/5/2.3/M3 SAK2.5	B.32	0294500000	GZ 2.0A	A.28	0303000000	KISC M3X20.5/10 EK4	I.10	0317200000	H35,0/30 BE	J.22
0280600000	STB 8.5/5/2.3/M3 SAK2.5	B.38	0294600000	GZ 5.0A	B.26	0303000000	KISC M3X20.5/10 EK4	D.2	0317300000	H35,0/39 BE	J.22
0280600000	STB 8.5/5/2.3/M3 SAK2.5	B.39	0294600000	GZ 5.0A	A.28	0303000000	KISC M3X20.5/10 EK4	B.28	0318000000	VH 19/6/4.2 SAKT1	B.32
0280600000	STB 8.5/5/2.3/M3 SAK2.5	C.2	0295700000	GZ 3.0A	A.28	0303000000	KISC M3X20.5/10 EK4	I.9	0318000000	VH 19/6/4.2 SAKT1	A.32
0280600000	STB 8.5/5/2.3/M3 SAK2.5	A.2	0295700000	GZ 3.0A	B.26	0303000000	KISC M3X20.5/10 EK4	A.11	0318000000	VH 19/6/4.2 SAKT1	A.33
0280600000	STB 8.5/5/2.3/M3 SAK2.5	I.15	0295700000	GZ 3.0A	A.23	0303000000	VH 4.5/5/3.5 SAK6N-16	I.10	0318000000	VH 19/6/4.2 SAKT1	B.31
0280600000	STB 8.5/5/2.3/M3 SAK2.5	B.2	0295800000	GZ 7.0A	A.28	0303000000	BFSC M2.5X18 PA/RT	E.11	0318000000	VH 19/6/4.2 SAKT1	I.21
0280600000	STB 8.5/5/2.3/M3 SAK2.5	I.15	0295800000	GZ 7.0A	B.26	0303000000	BFSC M2.5X18 PA/RT	B.11	0318560000	TW AKZ2.5	E.2
0280600000	STB 8.5/5/2.3/M3 SAK2.5	B.45	0295900000	FKSC M5X8 D9/SW2.5	H.14	0303000000	BFSC M2.5X18 PA/RT	I.17	0318560000	TW AKZ2.5	E.13
0280600000	STB 8.5/5/2.3/M3 SAK2.5	A.40	0296200000	BFSC M3X30	B.28	0303000000	BFSC M2.5X18 PA/RT	A.12	0318560000	TW AKZ2.5 BL	E.2
0280600000	STB 8.5/5/2.3/M3 SAK2.5	A.7	0296200000	BFSC M3X30	A.11	0303000000	BFSC M2.5X18 PA/RT	E.12	0319160000	TSCH 1	A.9
0281120000	TW SAK16 KRG	B.7	0296200000	BFSC M3X30	I.10	0303000000	BFSC M2.5X18 PA/RT	A.13	0319160000	TSCH 1	B.2
0281120000	TW SAK16 KRG	A.9	0296700000	BFSC M5X8 Schlitz	H.3	0303000000	BFSC M2.5X18 PA/RT	E.10	0319160000	TSCH 1	A.8
0282600000	H0,5/6	J.33	0296800000	VH 5/4/2.8 AKZ4	I.9	0303400000	AD 4 AKZ4	E.10	0319160000	TSCH 1	A.37
0282700000	H0,75/6	J.33	0297100000	TW SAK2.5 HP/TF/GE/1	B.16	0303400000	AD 4 AKZ4	B.39	0319160000	TSCH 1	A.7
0282800000	H1,0/10	J.33	0297100000	TW SAK2.5 HP/TF/GE/1	B.18	0303400000	AD 4 AKZ4	E.12	0319160000	TSCH 1	B.4
0282900000	H10,0/12	J.33	0297100000	TW SAK2.5 HP/TF/GE/1	A.40	0303400000	AD 4 AKZ4	E.11	0319160000	TSCH 1	B.39
0283100000	AD 4 WSD SAKG32 HP/DBR	I.17	0297200000	QL 2 DLJ	I.9	0303400000	AD 4 AKZ4	B.45	0319160000	TSCH 1	A.2
0284110000	SK E16/SAKS2	A.26	0297300000	QL 3 DLJ	I.9	0303400000	AD 4 AKZ4	B.11	0319160000	TSCH 1	B.3
0284110000	SK E16/SAKS2	B.24	0297520000	SAKS 3 G/5X30 500V	B.23	0303400000	AD 4 AKZ4	A.7	0319160000	TSCH 1	C.3
0284700000	BSTO 28/8 MK3/8	F.6	0297600000	AD 3 SAK4	I.17	0303400000	AD 4 AKZ4	A.40	0319160000	TSCH 1	A.11
0284700000	BSTO 28/8 MK3/8	F.2	0297700000	AD 3 SAK6N	I.17	0303400000	AD 4 AKZ4	A.13	0319160000	TSCH 1	A.36
0285100000	VH 19/5/3.5 SAK4-16	B.6	0297800000	AD 3 SAK16	B.4	0303400000	AD 4 AKZ4	I.17	0319160000	TSCH 1	B.28
0285100000	VH 19/5/3.5 SAK4-16	B.3	0297800000	AD 3 SAK16	I.17	0303400000	AD 4 AKZ4	B.6	0319160000	TSCH 1	C.2
0285100000	VH 19/5/3.5 SAK4-16	B.7	0297900000	AD 3 SAK2.5	B.2	0303520000	SAK 35 KRG	B.8	0319160000	TSCH 1	C.4
0285100000	VH 19/5/3.5 SAK4-16	A.4	0297900000	AD 3 SAK2.5	A.12	0303560000	SAK 35	B.4	0319160000	TSCH 1	B.7
0285100000	VH 19/5/3.5 SAK4-16	B.4	0297900000	AD 3 SAK2.5	C.2	0303580000	SAK 35 BL	B.4	0319160000	TSCH 1	C.5
0285100000	VH 19/5/3.5 SAK4-16	A.3	0297900000	AD 3 SAK2.5	I.17	0303620000	AP SAK35 KRG	I.6	0319160000	TSCH 1	B.38
0285100000	VH 19/5/3.5 SAK4-16	C.5	0297900000	AD 3 SAK2.5	A.2	0303620000	AP SAK35 KRG	I.4	0319160000	TSCH 1	B.36
0285100000	VH 19/5/3.5 SAK4-16	A.8	0298020000	AST 3 6.3 KRG	B.42	0303620000	AP SAK35 KRG	B.8	0319160000	TSCH 1	A.3
0285100000	VH 19/5/3.5 SAK4-16	C.2	0298120000	AP AST3+4 KRG	A.36	0303620000	AP SAK35 KRG	B.9	0319160000	TSCH 1	B.6
0285100000	VH 19/5/3.5 SAK4-16	I.12	0298120000	AP AST3+4 KRG	B.43	0303620000	AP SAK35 KRG	A.9	0319160000	TSCH 1	B.42
0285100000	VH 19/5/3.5 SAK4-16	C.3	0298120000	AP AST3+4 KRG	B.42	0303660000	AP SAK35/TW SAK16	B.5	0319160000	TSCH 1	B.45
0285100000	VH 19/5/3.5 SAK4-16	A.7	0298120000	AP AST3+4 KRG	I.4	0303660000	AP SAK35/TW SAK16	I.6	0319160000	TSCH 1	A.4
0285100000	VH 19/5/3.5 SAK4-16	C.4	0298120000	AP AST3+4 KRG	I.6	0303660000	AP SAK35/TW SAK16	C.4	0319160000	TSCH 1	B.43
0285100000	VH 19/5/3.5 SAK4-16	A.9	0298700000	VH 24.5/8/5 SAK35	A.5	0303660000	AP SAK35/TW SAK16	I.4	0319160000	TSCH 1	A.40
0285300000	AD 4 SAK4	C.4	0298700000	VH 24.5/8/5 SAK35	B.8	0303660000	AP SAK35/TW SAK16	A.4	0320000000		
0285300000	AD 4 SAK4	A.3	0298700000	VH 24.5/8/5 SAK35	A.4	0303660000	AP SAK35/TW SAK16	A.5	0321320000	SAKS 4	B.24
0285300000	AD 4 SAK4	B.3	0298700000	VH 24.5/8/5 SAK35	B.5	0303660000	AP SAK35/TW SAK16	B.4	0322110000	ZB 4G SW	H.7
0285300000	AD 4 SAK4	B.6	0298700000	VH 24.5/8/5 SAK35	I.12	0303670000	AP SAK35 KRG/BL	B.8	0322160000	ZB 4G GN/GE	H.7
0285300000	AD 4 SAK4	C.5	0298700000	VH 24.5/8/5 SAK35	A.4	0303670000	AP SAK35 KRG/BL	B.9	0322180000	ZB 4G BL	H.7
0285300000	AD 4 SAK4	I.17	0298800000	BFSC M4X35	B.4	0303670000	AP SAK35 KRG/BL	I.6	0323100000	EK 2	B.14
0285300000	AD 4 SAK4	A.7	0298800000	BFSC M4X35	B.5	0303670000	AP SAK35 KRG/BL	B.7	0324120000	SAKC 10 2STB	B.19
0285300000	AD 4 SAK4	C.2	0298900000	BFSC M4X35	B.4	0303680000	AP SAK35/TW SAK16 BL	E.11	0324460000	AKZ 4 S WA 2X2.8	E.9
0286400000	DSTV VH 6.5	I.10	0298900000	BFSC M4X35	A.5	0303680000	AP SAK35/TW SAK16 BL	B.12	0324560000	AKZ 4 SS SE 6.3/2.8	E.8
0286620000	SAKG 32 I	B.48	0298900000	BFSC M4X35	B.8	0303680000	AP SAK35/TW SAK16 BL	I.6	0326660000	AH 28 SAKG28	I.17
0286720000	SAKG 32 III	B.49	0298900000	BFSC M4X35	I.12	0303680000	AP SAK35/TW SAK16 BL	B.4	0326660000	AH 28 SAKG28	B.48
0286820000	SAKG 40 I	B.50	0299600000	PS 4 F.STB 4	A.4	0303680000	AP SAK35/TW SAK16 BL	B.4	0326660000	AH 28 SAKG28	B.46
0286920000	SAKG 40 III	B.51	0299600000	PS 4 F.STB 4	B.5	0303680000	AP SAK35/TW SAK16 BL	E.11	0326660000	AH 28 SAKG28	B.47
0289300000	BSTO 28/4 MK3/4	F.6	0299600000	PS 4 F.STB 4	D.9	0303680000	AP SAK35/TW SAK16 BL	I.10	0326760000	AH 32 SAKG32	A.44
0289300000	BSTO 28/4 MK3/4	F.2	0299600000	PS 4 F.STB 4	A.4	0303680000	AP SAK35/TW SAK16 BL	B.9	0326760000	AH 32 SAKG32	A.42
0289500000	BSTO 28/6 MK	F.2	0299600000	PS 4 F.STB 4	B.4	0304320000	TW SAK35 KRG	A.9	0326760000	AH 32 SAKG32	A.43
0289500000	BSTO 28/6 MK	F.6	0299600000	PS 4 F.STB 4	A.20	0304320000	TW SAK35 KRG	B.8	0326760000	AH 32 SAKG32	B.48
0290000000			0299600000	PS 4 F.STB 4	A.33	0304360000	TW SAK35	A.5	0326760000	AH 32 SAKG32	B.48
0290000000	BSTB 28/6 MK U 1-6	F.6	0299600000	PS 4 F.STB 4	B.5	0304360000	TW SAK35	C.4	0326760000	AH 32 SAKG32	B.50
0290000000	BSTB 28/6 MK U 1-6	F.2	0299600000	PS 4 F.STB 4	C.3	0304360000	TW SAK35	B.4	0326760000	AH 32 SAKG32	B.49
0290200000	BSTB 28/8 MK U 1-8	F.2	0299600000	PS 4 F.STB 4	B.19	0304360000	TW SAK35	A.4	0326860000	AH 40 SAKG40	B.51
0290200000	BSTB 28/8 MK U 1-8	F.6	0299600000	PS 4 F.STB 4	B.30	0304360000	TW SAK35	B.5	0326860000	AH 40 SAKG40	B.51
0292460000	SCHT 5	K.17	0299600000	PS 4 F.STB 4	B.3	0306120000	SAKS 1/32 G20 GL 230VAC	B.22	0326860000	AH 40 SAKG40	I.17
0292500000	BFSC M3X25	A.3	0299600000	PS 4 F.STB 4	I.14	0307300000	QVS 2 SAKT1+2	B.31	0326860000	AH 40 SAKG40	A.46
0292500000	BFSC M3X25	C.2	0299600000	PS 4 F.STB 4	A.9	0307300000	QVS 2 SAKT1+2	A.32	0326860000	AH 40 SAKG40	B.50
0292500000	BFSC M3X25	C.3	0299600000	PS 4 F.STB 4	B.8	0307300000	QVS 2 SAKT1+2	I.20	0326960000	AH 46 SAKG46	B.52
0292500000	BFSC M3X25	A.7	0299600000	PS 4 F.STB 4	B.31	0307300000	QVS 2 SAKT1+2	A.33	0326960000	AH 46 SAKG46	I.17
0292500000	BFSC M3X25	I.12	0299600000	PS 4 F.STB 4	B.9	0307300000	QVS 2 SAKT1+2	B.32	0326960000	AH 46 SAKG46	A.46
0292500000	BFSC M3X25	C.4	0299600000	PS 4 F.STB 4	A.32	0307400000	QVS 4 SAKT1+2	B.32	0326960000	AH 46 SAKG46	A.47
0292500000	BFSC M3X25	A.8	0299600000	PS 4 F.STB 4	B.10	0307400000	QVS 4 SAKT1+2	B.31	0328000000	QL 2 SAKS4	B.25
0292500000	BFSC M3X25	A.9	0299600000	PS 4 F.STB 4	D.6	0307400000	QVS 4 SAKT1+2	A.32	0328000000	QL 2 SAKS4	I.9
0292500000	BFSC M3X25	I.10	0299600000	PS 4 F.STB 4	B.29	0307400000	QVS 4 SAKT1+2	A.33	0328000000	QL 2 SAKS4	B.24
0292500000	BFSC M3X25	C.5	0299600000	PS 4 F.STB 4	B.28	0307400000	QVS 4 SAKT1+2	I.20	0328000000	QL 2 SAKS4	A.27
0292500000	BFSC M3X25	B.7	0299600000	PS 4 F.STB 4	A.4	0308000000		I.10	0328000000	QL 2 SAKS4	A.26
0292500000	BFSC M3X25	A.4	0299600000	PS 4 F.STB 4	C.32	0309220000	AP SAK2.5L KRG	I.4	0328100000	QL 3 SAKS4	B.25
0292500000	BFSC M3X25	B.6	0299600000	PS 4 F.STB							

Order No.	Type	Page	Order No.	Type	Page	Order No.	Type	Page	Order No.	Type	Page
0328400000	E 14/10A RT	B.26	0336500000	Q 3 AKZ4	B.57	0337200000	Q 4 SAK2.5	B.2	0344400000	BFSC M5X45 PA/NA	B.9
0328400000	E 14/10A RT	A.28	0336500000	Q 3 AKZ4	A.55	0337200000	Q 4 SAK2.5	C.2	0345300000	QL 2 SAK70	A.6
0328500000	E 14/16A GR	B.24	0336500000	Q 3 AKZ4	E.11	0337600000	SAK 10/EN	C.3	0345300000	QL 2 SAK70	B.9
0328500000	E 14/16A GR	B.26	0336500000	Q 3 AKZ4	I.11	0338100000	QL 10 SAK2.5	I.9	0345300000	QL 2 SAK70	I.9
0328500000	E 14/16A GR	A.28	0336500000	Q 3 AKZ4	B.56	0338100000	QL 10 SAK2.5	A.33	0345500000	VH 30.5/11/5.5 SAK70	I.9
0328500000	E 14/16A GR	A.26	0336600000	Q 4 AKZ4	B.58	0338100000	QL 10 SAK2.5	B.32	0345500000	VH 30.5/11/5.5 SAK70	B.9
0328600000	P 14/6 D01 GN SAKS4	B.27	0336600000	Q 4 AKZ4	A.55	0338100000	QL 10 SAK2.5	I.10	0345500000	VH 30.5/11/5.5 SAK70	A.6
0328600000	P 14/6 D01 GN SAKS4	A.26	0336600000	Q 4 AKZ4	A.54	0338200000	QL 10 SAK4	B.37	0345600000	BFSC M5X45	A.6
0328600000	P 14/6 D01 GN SAKS4	B.24	0336600000	Q 4 AKZ4	A.12	0338200000	QL 10 SAK4	A.38	0345600000	BFSC M5X45	B.9
0328600000	P 14/6 D01 GN SAKS4	A.29	0336600000	Q 4 AKZ4	B.61	0338200000	QL 10 SAK4	A.37	0345600000	BFSC M5X45	I.9
0328700000	P 14/10 D01 RT SAKS4	A.26	0336600000	Q 4 AKZ4	A.53	0338200000	QL 10 SAK4	I.10	0346100000	SS M5 D 128-A 5	A.10
0328700000	P 14/10 D01 RT SAKS4	A.26	0336600000	Q 4 AKZ4	A.39	0338200000	QL 10 SAK4	I.9	0346100000	SS M5 D 128-A 5	B.9
0328700000	P 14/10 D01 RT SAKS4	B.27	0336600000	Q 4 AKZ4	B.59	0338200000	QL 10 SAK4	B.44	0346100000	SS M5 D 128-A 5	A.6
0328700000	P 14/10 D01 RT SAKS4	A.29	0336600000	Q 4 AKZ4	B.60	0338300000	QL 10 SAK6N	B.31	0346200000	KISC M3X6 SAKS1	I.9
0328920000	SAKS 3/35 G/5X30 500V	A.25	0336600000	Q 4 AKZ4	A.56	0338300000	QL 10 SAK6N	A.11	0346460000	AKZ 4 LL VS	E.11
0329120000	AP SAKT2 KRG	I.6	0336600000	Q 4 AKZ4	B.57	0338300000	QL 10 SAK6N	I.9	0347960000	TSK 31.5 GR	I.16
0329120000	AP SAKT2 KRG	I.4	0336600000	Q 4 AKZ4	E.3	0338300000	QL 10 SAK6N	I.10	0348260000	TW AKZ4	E.9
0329300000	QVS 3 SAKT1+2	I.20	0336600000	Q 4 AKZ4	A.50	0338300000	QL 10 SAK6N	I.21	0348260000	TW AKZ4	E.13
0329300000	QVS 3 SAKT1+2	A.33	0336600000	Q 4 AKZ4	A.38	0338300000	QL 10 SAK6N	B.28	0348260000	TW AKZ4	E.12
0329300000	QVS 3 SAKT1+2	B.31	0336600000	Q 4 AKZ4	A.51	0338300000	QL 10 SAK6N	B.32	0348260000	TW AKZ4	E.3
0329300000	QVS 3 SAKT1+2	B.32	0336600000	Q 4 AKZ4	E.9	0338300000	QL 10 SAK6N	A.32	0348260000	TW AKZ4	E.8
0329300000	QVS 3 SAKT1+2	A.32	0336600000	Q 4 AKZ4	B.11	0338300000	QL 10 SAK6N	A.33	0348260000	TW AKZ4	E.11
0329660000	AP AKZ1.5W	E.10	0336600000	Q 4 AKZ4	I.11	0338400000	QL 10 SAKB10	B.30	0348260000	TW AKZ4	E.10
0329660000	AP AKZ1.5W	I.6	0336600000	Q 4 AKZ4	A.52	0338500000	QL 10 SAKA10	B.19	0348280000	TW AKZ4 BL	E.3
0329660000	AP AKZ1.5W	I.4	0336600000	Q 4 AKZ4	A.13	0338500000	QL 10 SAKA10	B.30	0348660000	EWK AKA 2.5	H.13
			0336600000	Q 4 AKZ4	B.37	0338600000	QL 10 SAK35	C.4	0348700000	VH 23/6/4.2 SAKA10	B.30
			0336600000	Q 4 AKZ4	E.12	0338600000	QL 10 SAK35	B.8	0348900000	SSCH 10X3X1000 CU/SN	G.7
			0336600000	Q 4 AKZ4	B.10	0338600000	QL 10 SAK35	A.5	0348900000	SSCH 10X3X1000 CU/SN	G.6
			0336600000	Q 4 AKZ4	B.38	0338600000	QL 10 SAK35	A.4	0348900000	SSCH 10X3X1000 CU/SN	G.5
			0336600000	Q 4 AKZ4	E.13	0338600000	QL 10 SAK35	I.11	0348900000	SSCH 10X3X1000 CU/SN	G.4
			0336600000	Q 4 AKZ4	E.11	0338600000	QL 10 SAK35	I.9	0348900000	SSCH 10X3X1000 CU/SN	H.3
			0336600000	Q 4 AKZ4	E.10	0338600000	QL 10 SAK35	B.4	0348900000	SSCH 10X3X1000 CU/SN	A.31
			0336600000	Q 4 AKZ4	B.56	0338600000	QL 10 SAK35	B.5	0348900000	SSCH 10X3X1000 CU/SN	A.30
			0336600000	Q 2 SAK4	C.2	0338800000	QL 10 SAKS1	I.9			
			0336600000	Q 2 SAK4	C.4	0338800000	QL 10 SAKS1	B.23			
			0336600000	Q 2 SAK4	A.37	0338800000	QL 10 SAKS1	A.25			
			0336600000	Q 2 SAK4	B.37	0338800000	QL 10 SAKS1	A.24			
			0336600000	Q 2 SAK4	C.5	0338900000	QL 10 SAKS2	A.26			
			0336600000	Q 2 SAK4	I.9	0338900000	QL 10 SAKS2	A.27			
			0336600000	Q 2 SAK4	B.36	0338900000	QL 10 SAKS2	I.9			
			0336600000	Q 2 SAK4	A.36	0338900000	QL 10 SAKS2	B.25			
			0336600000	Q 2 SAK4	A.33	0338900000	QL 10 SAKS2	B.24			
			0336600000	Q 2 SAK4	D.6	0339000000	QL 10 SAKS4	A.27			
			0336600000	Q 2 SAK4	A.7	0339000000	QL 10 SAKS4	I.9			
			0336600000	Q 2 SAK4	B.6	0339000000	QL 10 SAKS4	B.24			
			0336600000	Q 2 SAK4	B.42	0339000000	QL 10 SAKS4	B.25			
			0336600000	Q 2 SAK4	B.43	0339000000	QL 10 SAKS4	A.26			
			0336600000	Q 3 SAK4	A.3	0339410000	SK E14 SAKS4	A.26			
			0336600000	Q 3 SAK4	A.37	0339410000	SK E14 SAKS4	B.24			
			0336600000	Q 3 SAK4	B.36	0339760000	SAK 16/EN	C.3			
			0336600000	Q 3 SAK4	C.4	0339860000	SAK 35/EN	C.4			
			0336600000	Q 3 SAK4	I.9						
			0336600000	Q 3 SAK4	B.6						
			0336600000	Q 3 SAK4	C.5						
			0336600000	Q 3 SAK4	D.6						
			0336600000	Q 3 SAK4	A.7						
			0336600000	Q 3 SAK4	D.6						
			0336600000	Q 3 SAK4	B.38						
			0336600000	Q 3 SAK4	E.13						
			0336600000	Q 3 SAK4	A.12						
			0336600000	Q 3 SAK4	B.60						
			0336600000	Q 3 SAK4	B.10						
			0336600000	Q 3 SAK4	B.11						
			0336600000	Q 4 SAK4	E.12						
			0336600000	Q 4 SAK4	E.9						
			0336600000	Q 4 SAK4	E.3						
			0336600000	Q 4 SAK4	A.38						
			0336600000	Q 4 SAK4	A.50						
			0336600000	Q 4 SAK4	B.56						
			0336600000	Q 4 SAK4	I.11						
			0336600000	Q 4 SAK4	A.51						
			0336600000	Q 4 SAK4	A.53						
			0336600000	Q 4 SAK4	A.52						
			0336600000	Q 4 SAK4	A.13						
			0336600000	Q 4 SAK4	I.9						
			0336600000	Q 4 SAK4	B.58						
			0336600000	Q 4 SAK4	B.59						
			0336600000	Q 2 SAK2.5	A.54						
			0336500000	Q 3 SAK2.5	A.50						
			0336500000	Q 3 SAK2.5	B.10						
			0336500000	Q 3 SAK2.5	B.60						
			0336500000	Q 3 SAK2.5	B.61						
			0336500000	Q 3 SAK2.5	E.10						
			0336500000	Q 3 SAK2.5	A.51						
			0336500000	Q 3 SAK2.5	E.9						
			0336500000	Q 3 SAK2.5	A.13						
			0336500000	Q 3 SAK2.5	B.58						
			0336500000	Q 3 SAK2.5	E.3						
			0336500000	Q 3 SAK2.5	A.52						
			0336500000	Q 3 SAK2.5	E.13						
			0336500000	Q 3 SAK2.5	B.59						
			0336500000	Q 3 SAK2.5	B.38						
			0336500000	Q 3 SAK2.5	A.12						
			0336500000	Q 3 SAK2.5	E.12						
			0336500000	Q 3 SAK2.5	I.9						
			0336500000	Q 3 SAK2.5	A.39						
			0336500000	Q 3 SAK2.5	A.54						
			0336500000	Q 4 SAK2.5	B.11						
			0336500000	Q 4 SAK2.5	B.37						
			0336500000	Q 4 SAK2.5	A.56						
			0336500000	Q 4 SAK2.5	A.38						
			0336500000	Q 4 SAK2.5	B.39						
			0336500000	Q 4 SAK2.5	A.53						
			0336500000	Q 4 SAK2.5	B.38						
			0336500000	Q 4 SAK2.5	B.39						
			0336500000	Q 4 SAK2.5	B.38						
			0336500000	Q 4 SAK2.5	B.39						
			0336500000	Q 4 SAK2.5	B.38						
			0336500000	Q 4 SAK2.5	B.39						
			0336500000	Q 4 SAK2.5	B.38						
			0336500000	Q 4 SAK2.5	B.39						
			0336500000	Q 4 SAK2.5	B.38						
			0336500000	Q 4 SAK2.5	B.39						
			0336500000	Q 4 SAK2.5	B.38						
			0336500000	Q 4 SAK2.5	B.39						
			0336500000	Q 4 SAK2.5	B.38						
			0336500000	Q 4 SAK2.5	B.39						
			0336500000	Q 4 SAK2.5	B.38						
			0336500000	Q 4 SAK2.5	B.39						
			0336500000	Q 4 SAK2.5	B.38						
			0336500000	Q 4 SAK2.5	B.39						
			0336500000	Q 4 SAK2.5	B.38						
			0336500000	Q 4 SAK2.5	B.39						
			0336500000	Q 4 SAK2.5	B.38						
			0336500000	Q 4 SAK2.5	B.39						
			0336500000	Q 4 SAK2.5	B.38						

Order No.	Type	Page	Order No.	Type	Page	Order No.	Type	Page	Order No.	Type	Page
0361600000	E 18/50A WS	A.28	0368800000	Q 10 SAK4	B.42	0386060000	IH 2.8 DB	A.39	0430400000	G 20/0.20A/F	B.20
0361600000	E 18/50A WS	B.26	0368800000	Q 10 SAK4	C.5	0386260000	IH 6.3 WEM GE	B.37	0430400000	G 20/0.20A/F	B.21
0361700000	E 18/63A KU	B.26	0368800000	Q 10 SAK4	B.43	0386260000	IH 6.3 WEM GE	A.38	0430500000	G 20/0.25A/F	B.26
0361700000	E 18/63A KU	A.27	0368800000	Q 10 SAK4	I.9	0386260000	IH 6.3 WEM GE	B.36	0430500000	G 20/0.25A/F	B.21
0361700000	E 18/63A KU	B.25	0368800000	Q 10 SAK4	D.6	0386260000	IH 6.3 WEM GE	E.9	0430500000	G 20/0.25A/F	A.22
0361700000	E 18/63A KU	A.28	0368800000	Q 10 SAK4	A.36	0386260000	IH 6.3 WEM GE	B.43	0430500000	G 20/0.25A/F	A.28
0361800000	P 18/20 D02 BL SAKS5	A.29	0368800000	Q 10 SAK4	A.37	0386260000	IH 6.3 WEM GE	A.36	0430500000	G 20/0.25A/F	B.20
0361800000	P 18/20 D02 BL SAKS5	B.25	0368800000	Q 10 SAK4	C.4	0386260000	IH 6.3 WEM GE	A.39	0430500000	G 20/0.25A/F	A.23
0361800000	P 18/20 D02 BL SAKS5	A.27	0368800000	Q 10 SAK4	A.7	0386260000	IH 6.3 WEM GE	B.44	0430600000	G 20/0.50A/F	A.28
0361800000	P 18/20 D02 BL SAKS5	B.27	0368900000	H35,0/18	J.33	0386260000	IH 6.3 WEM GE	E.8	0430600000	G 20/0.50A/F	B.21
0361900000	P 18/25 D02 GE SAKS5	B.25	0369000000	Q 2 AKZ4SS	I.11	0386260000	IH 6.3 WEM GE	A.37	0430600000	G 20/0.50A/F	B.20
0361900000	P 18/25 D02 GE SAKS5	B.27	0369000000	Q 2 AKZ4SS	E.8	0386260000	IH 6.3 WEM GE	B.42	0430600000	G 20/0.50A/F	A.23
0361900000	P 18/25 D02 GE SAKS5	A.29	0369100000	Q 3 AKZ4SS	I.11	0388500000	STB 35 IH/SW	I.20	0430600000	G 20/0.50A/F	B.26
0361900000	P 18/25 D02 GE SAKS5	A.27	0369100000	Q 3 AKZ4SS	E.8	0388500000	STB 35 IH/SW	I.15	0430600000	G 20/0.50A/F	A.22
0362000000	P 18/35 D02 SW SAKS5	B.27	0369200000	Q 4 AKZ4SS	I.11	0388600000	STB 35 IH/GR	I.20	0430700000	G 20/1.00A/F	B.20
0362000000	P 18/35 D02 SW SAKS5	B.25	0369200000	Q 4 AKZ4SS	E.8	0388600000	STB 35 IH/GR	I.15	0430700000	G 20/1.00A/F	A.28
0362000000	P 18/35 D02 SW SAKS5	A.29	0369300000	Q 10 AKZ4SS	E.8	0388700000	STB 35 IH/BL	I.20	0430700000	G 20/1.00A/F	A.22
0362000000	P 18/35 D02 SW SAKS5	A.27	0369300000	Q 10 AKZ4SS	I.11	0388700000	STB 35 IH/BL	I.15	0430700000	G 20/1.00A/F	B.26
0362100000	P 18/50 D02 WS SAKS5	B.27				0388800000	STB 35 IH/RT	I.15	0430700000	G 20/1.00A/F	A.23
0362100000	P 18/50 D02 WS SAKS5	B.25				0388800000	STB 35 IH/RT	I.20	0430700000	G 20/1.00A/F	B.21
0362100000	P 18/50 D02 WS SAKS5	A.29				0388900000	STB 35 IH/RT	I.20	0430800000	G 20/1.60A/F	B.21
0362100000	P 18/50 D02 WS SAKS5	A.27				0388900000	STB 35 IH/RT	I.15	0430800000	G 20/1.60A/F	B.20
0362460000	AKZ 4 SS WA 2X2.8	E.8	0370160000	MK 10/14	F.9	0389000000	STB 35 IH/GE	I.15	0430800000	G 20/1.60A/F	A.23
0362800000	BFSC M4X20	B.19	0371420000	SAKS 1/32 G20 LD 24VDC	B.22	0389000000	STB 35 IH/GE	I.20	0430800000	G 20/1.60A/F	A.22
0362800000	BFSC M4X20	A.20	0372600000	H1,0/6	J.33	0389100000	STB 35 IH/VI	I.20	0430800000	G 20/1.60A/F	A.28
0363360000	TSCH 4 AKZ4	E.13	0372700000	H1,5/7	J.33	0389100000	STB 35 IH/VI	I.15	0430800000	G 20/1.60A/F	B.26
0363360000	TSCH 4 AKZ4	A.55	0373000000	H2,5/7	J.33				0430900000	G 20/2.00A/F	A.28
0363360000	TSCH 4 AKZ4	B.57	0373100000	H4,0/9	J.33				0430900000	G 20/2.00A/F	B.21
0363360000	TSCH 4 AKZ4	A.51	0374660000	EK 16	B.13				0430900000	G 20/2.00A/F	B.20
0363360000	TSCH 4 AKZ4	A.53	0375200000	H16,0/18	J.33	0395460000	DK 4/35 LD GR 24VDC	A.50	0430900000	G 20/2.00A/F	A.23
0363360000	TSCH 4 AKZ4	E.3	0375300000	H25,0/18	J.33	0395760000	DK 4/35 LD GR 24VDC	A.50	0430900000	G 20/2.00A/F	B.26
0363360000	TSCH 4 AKZ4	A.54	0376860000	ASK 1/15	E.6	0395960000	DK 4/35 LD ROT 24VAC	A.51	0430900000	G 20/2.00A/F	A.22
0363360000	TSCH 4 AKZ4	A.52	0377100000	KISC M3X20 SAK10 CU5	A.33	0396360000	DK 4/35 1D GET.SCH.	A.53	0431000000	G 20/2.50A/F	B.20
0363360000	TSCH 4 AKZ4	E.12	0377100000	KISC M3X20 SAK10 CU5	I.12	0396660000	DK 4/35 2D GET.SCH. A1	A.54	0431000000	G 20/2.50A/F	A.22
0363360000	TSCH 4 AKZ4	E.11	0377100000	KISC M3X20 SAK10 CU5	A.32	0396760000	DK 4/35 2D GET.SCH. A1	A.55	0431000000	G 20/2.50A/F	B.26
0363360000	TSCH 4 AKZ4	B.60	0377100000	KISC M3X20 SAK10 CU5	B.31	0396860000	DK 4/35 2D GET.SCH. A2	A.55	0431000000	G 20/2.50A/F	A.28
0363360000	TSCH 4 AKZ4	B.56	0377100000	KISC M3X20 SAK10 CU5	B.32	0396960000	DK 4/35 1D 1K5 GET.SCH	A.55	0431000000	G 20/2.50A/F	B.21
0363360000	TSCH 4 AKZ4	B.59	0377100000	KISC M3X20 SAK10 CU5	I.21				0431000000	G 20/2.50A/F	A.23
0363360000	TSCH 4 AKZ4	B.38	0377200000	KISC M3X15/6 SAK2.5 CU5	B.32				0431100000	G 20/3.15A/F	B.20
0363360000	TSCH 4 AKZ4	A.50	0377200000	KISC M3X15/6 SAK2.5 CU5	I.12				0431100000	G 20/3.15A/F	A.28
0363360000	TSCH 4 AKZ4	B.61	0377200000	KISC M3X15/6 SAK2.5 CU5	A.33	0400100000	KISC M2.5X11/4.5 AKZ1.5	I.9	0431100000	G 20/3.15A/F	A.22
0363360000	TSCH 4 AKZ4	E.10	0379300000	H10,0/18	J.33	0401220000	SAK 4 S 6.3/2.8/KRG	B.44	0431100000	G 20/3.15A/F	B.21
0363360000	TSCH 4 AKZ4	B.58	0379400000	STB 6/D3.7/2.3/M3 SAKR	B.16	0401260000	SAK 4 S 6.3/2.8	B.37	0431100000	G 20/3.15A/F	A.23
0363360000	TSCH 4 AKZ4	A.13	0379400000	STB 6/D3.7/2.3/M3 SAKR	B.18	0401360000	AP DUSA4/35	I.6	0431100000	G 20/3.15A/F	B.26
0363360000	TSCH 4 AKZ4	A.13	0379400000	STB 6/D3.7/2.3/M3 SAKR	B.40	0401460000	SO SH1	H.4	0431200000	G 20/4.00A/F	B.26
0364200000	AK 95	H.5	0379400000	STB 6/D3.7/2.3/M3 SAKR	A.18	0407360000	DEK 6,5 FSZ 1-10	K.9	0431200000	G 20/4.00A/F	B.20
0364300000	TS 32X16.2 2M/CU/BK	H.10	0379400000	STB 6/D3.7/2.3/M3 SAKR	I.15	0407360011	DEK 6,5 FSZ 11-20	K.9	0431200000	G 20/4.00A/F	A.22
0368660000	TSCH 3 SAKD2.5 N	B.2				0407360021	DEK 6,5 FSZ 21-30	K.9	0431200000	G 20/4.00A/F	A.28
0368660000	TSCH 3 SAKD2.5 N	A.2				0407360031	DEK 6,5 FSZ 31-40	K.9	0431200000	G 20/4.00A/F	A.23
0367800000	Q 2 SAKD2.5N	B.2				0407360041	DEK 6,5 FSZ 41-50	K.9	0431200000	G 20/4.00A/F	B.21
0367800000	Q 2 SAKD2.5N	A.2	0380260000	AKE 4	E.5	0407360051	DEK 6,5 FSZ 51-60	K.9	0431300000	G 20/5.00A/F	B.21
0367900000	Q 3 SAKD2.5N	B.2	0380350000	AP ASK1 RT	I.6	0407360061	DEK 6,5 FSZ 61-70	K.9	0431300000	G 20/5.00A/F	B.26
0367900000	Q 3 SAKD2.5N	A.2	0380360000	AP ASK1	C.7	0407360071	DEK 6,5 FSZ 71-80	K.9	0431300000	G 20/5.00A/F	B.20
0368000000	Q 4 SAKD2.5N	A.2	0380360000	AP ASK1	I.6	0407360081	DEK 6,5 FSZ 81-90	K.9	0431300000	G 20/5.00A/F	A.28
0368000000	Q 4 SAKD2.5N	B.2	0380380000	AP ASK1 BL	I.6	0407360091	DEK 6,5 FSZ 91-100	K.9	0431300000	G 20/5.00A/F	A.23
0368100000	Q 10 SAKD2.5N	B.2	0380420000	SAK 2.5/35 KRG	B.2	0407600000	QL 3 SAKG28	B.46	0431300000	G 20/5.00A/F	A.22
0368100000	Q 10 SAKD2.5N	A.2	0380440000	SAK 2.5/35 OR	I.7	0407600000	QL 3 SAKG28	I.9	0431400000	G 20/6.30A/F	A.28
0368200000	Q 2 AKZ1.5	I.11	0380460000	SAK 2.5/35	A.2	0407600000	QL 3 SAKG28	B.47	0431400000	G 20/6.30A/F	B.26
0368200000	Q 2 AKZ1.5	E.2	0380470000	SAK 2.5/35 KRG/BL	A.7	0407600000	QL 3 SAKG28	A.10	0431400000	G 20/6.30A/F	B.20
0368200000	Q 2 AKZ1.5	E.10	0380470000	SAK 2.5/35 KRG/BL	I.7	0407600000	QL 3 SAKG28	B.9	0431400000	G 20/6.30A/F	B.21
0368300000	Q 3 AKZ1.5	I.11	0380480000	SAK 2.5/35 BL	A.2	0407700000	QL 4 SAKG28	B.47	0431400000	G 20/6.30A/F	A.22
0368300000	Q 3 AKZ1.5	E.10	0380480000	SAK 2.5/35 BL	I.7	0407700000	QL 4 SAKG28	I.9	0437720000	SAKT 2/LT 4STB	B.32
0368300000	Q 3 AKZ1.5	E.2	0380520000	SAK 6/35 KRG	A.8	0407700000	QL 4 SAKG28	A.10	0437920000	SAKT 1/LT STB14/4	B.31
0368400000	Q 4 AKZ1.5	E.10	0380560000	SAK 6/35 PA	A.3	0407700000	QL 4 SAKG28	B.46	0438000000	SSHCT 10X311000 ST/ZN	H.3
0368400000	Q 4 AKZ1.5	I.11	0380570000	SAK 6/35 KRG/BL	A.8	0407700000	QL 4 SAKG28	B.9	0438560000	AP DK4/380 Q	I.4
0368400000	Q 4 AKZ1.5	E.2	0380570000	SAK 6/35 KRG/BL	I.7	0407900000	IS 6 DIN 6911	J.20	0438560000	AP DK4/380 Q	I.6
0368500000	Q 10 AKZ1.5	E.2	0380580000	SAK 6/35 PA/BL	I.7	0408000000	QL 3 SAKG54	B.53	0439000000	G 20/0.63A/F	B.26
0368500000	Q 10 AKZ1.5	I.11	0380580000	SAK 6/35 PA/BL	A.3	0408000000	QL 3 SAKG54	A.47	0439000000	G 20/0.63A/F	A.22
0368500000	Q 10 AKZ1.5	E.10	0380620000	SAK 16/35 KRG	A.9	0408730000	AP SAKH 4EX	I.6	0439000000	G 20/0.63A/F	B.20
0368600000	Q 10 AKZ4	E.3	0380660000	SAK 16/35 PA	A.4	0409500000	H0,5/12 OR	J.22	0439000000	G 20/0.63A/F	A.28
0368600000	Q 10 AKZ4	E.9	0380680000	SAK 16/35 PA/BL	I.7	0409600000	H0,75/12 W	J.22	0439120000	AST 4 SF 6.3/2.8 KRG	B.43
0368600000	Q 10 AKZ4	B.38	0380680000	SAK 16/35 PA/BL	A.4	0409700000	H1,0/12 GE	J.22			
0368600000	Q 10 AKZ4	E.12	0380760000	SAK 35/35	A.4	0409800000	QL 4 SAKG40	B.50			
0368600000	Q 10 AKZ4	A.56	0380780000	SAK 35/35 BL	A.4	0409800000	QL 4 SAKG40	B.51			
0368600000	Q 10 AKZ4	E.11	0380780000	SAK 35/35 BL	I.7						
0368600000	Q 10 AKZ4	E.13	0382860000	EW 15	H.13						
0368600000	Q 10 AKZ4	A.13	0382860000	EW 15	E.2						
0368600000	Q 10 AKZ4	B.37	0382860000	EW 15	E.3	0412120000	SAKR KRG	B.18	0441500000	QL 3 SAKG32+70	A.44
0368600000	Q 10 AKZ4	A.38	0383400000	TS 35X7.5 2M/ST/ZN	H.11	0412160000	SAKR	B.16	0441500000	QL 3 SAKG32+70	B.49
0368600000	Q 10 AKZ4	B.11	0383410000	TS 35X7.5 1M/ST/ZN	H.11	0412180000	SAKR BL	I.7	0441500000	QL 3 SAKG32+70	B.50
0368600000	Q 10 AKZ4	A.39	0383530000	EW 35 GR 7032	H.13	0412180000	SAKR BL	B.16	0441600000	QL 4 SAKG32+70	B.49
0368600000	Q 10 AKZ4	A.52	0383560000	EW 35	A.56	0412220000	SAKR 2STB KRG	B.18	0441600000	QL 4 SAKG32+70	A.43
0368600000	Q 10 AKZ4	B.10	0383560000	EW 35	C.8	0412260000	SAKR 2STB	B.16	0441600000	QL 4 SAKG32+70	A.42
0368600000	Q 10 AKZ4	A.12	0383560000	EW 35	H.13	0412280000	SAKR 2STB BL	B.16	0441600000	QL 4 SAKG32+70	A.44
0368600000</											

Order No.	Type	Page	Order No.	Type	Page	Order No.	Type	Page	Order No.	Type	Page
0443780000	SAK 10/35 BL	I.7	0457300000	Q 4 SAK10	B.3	0468160801	DEK 6,5 FW 801-850	K.9	0473391692	DEK 5 BR NEUTRAL	K.7
0444200000	H50/36 OLIV	J.22	0457300000	Q 4 SAK10	A.8	0468160851	DEK 6,5 FW 851-900	K.9	0473391693	DEK 5 BL NEUTRAL	K.7
0444400000	QL 3 SAKG46	A.46	0457400000	Q 10 SAK10	I.9	0468160901	DEK 6,5 FW 901-950	K.9	0473391694	DEK 5 SW NEUTRAL	K.8
0444400000	QL 3 SAKG46	B.52	0457400000	Q 10 SAK10	C.3	0468160951	DEK 6,5 FW 951-999	K.9	0473460001	DEK 5 FW 1-50	K.7
0444400000	QL 3 SAKG46	A.47	0457400000	Q 10 SAK10	A.3	0468260001	DEK 6,5 FS 1-50	K.9	0473460051	DEK 5 FW 51-100	K.7
0444500000	QL 4 SAKG46	A.46	0457400000	Q 10 SAK10	A.8	0468260051	DEK 6,5 FS 101-150	K.9	0473460101	DEK 5 FW 101-150	K.7
0444500000	QL 4 SAKG46	B.52	0457400000	Q 10 SAK10	B.3	0468260101	DEK 6,5 FS 101-150	K.9	0473460151	DEK 5 FW 151-200	K.7
0444500000	QL 4 SAKG46	A.47	0457400000	Q 10 SAK10	B.7	0468260151	DEK 6,5 FS 151-200	K.9	0473460201	DEK 5 FW 201-250	K.7
0444900000	QL 3 SAKG40/35	A.45	0457500000	Q 2 SAK16	B.4	0468260201	DEK 6,5 FS 201-250	K.9	0473460251	DEK 5 FW 251-300	K.7
0445000000	QL 4 SAKG40/35	A.45	0457500000	Q 2 SAK16	C.3	0468260251	DEK 6,5 FS 251-300	K.9	0473460301	DEK 5 FW 301-350	K.7
0445420000	SAKT 2/LT O.STB	B.32	0457500000	Q 2 SAK16	A.9	0468260301	DEK 6,5 FS 301-350	K.9	0473460351	DEK 5 FW 351-400	K.7
0445860000	AKZ 4 SW 1X1	E.13	0457500000	Q 2 SAK16	A.4	0468260351	DEK 6,5 FS 351-400	K.9	0473460401	DEK 5 FW 401-450	K.7
0446100000	SBL/1912	A.22	0457500000	Q 2 SAK16	B.7	0468260401	DEK 6,5 FS 401-450	K.9	0473460451	DEK 5 FW 451-500	K.7
0446100000	SBL/1912	B.20	0457500000	Q 2 SAK16	I.9	0468260451	DEK 6,5 FS 451-500	K.9	0473460501	DEK 5 FW 501-550	K.7
0446200000	SBL/2111	B.20	0457600000	Q 3 SAK16	B.4	0468260501	DEK 6,5 FS 501-550	K.9	0473460551	DEK 5 FW 551-600	K.7
0446200000	SBL/2111	A.22	0457600000	Q 3 SAK16	A.9	0468260551	DEK 6,5 FS 551-600	K.9	0473460601	DEK 5 FW 601-650	K.7
0446300000	SBL/2489	A.23	0457600000	Q 3 SAK16	C.3	0468260601	DEK 6,5 FS 601-650	K.9	0473460651	DEK 5 FW 651-700	K.7
0446600000	VH 10/4/2.8 AKZ4	A.52	0457600000	Q 3 SAK16	B.7	0468260651	DEK 6,5 FS 651-700	K.9	0473460701	DEK 5 FW 701-750	K.7
0446600000	VH 10/4/2.8 AKZ4	E.11	0457600000	Q 3 SAK16	I.9	0468260701	DEK 6,5 FS 701-750	K.9	0473460751	DEK 5 FW 751-800	K.7
0446600000	VH 10/4/2.8 AKZ4	B.57	0457600000	Q 3 SAK16	A.4	0468260751	DEK 6,5 FS 751-800	K.9	0473460801	DEK 5 FW 801-850	K.7
0446600000	VH 10/4/2.8 AKZ4	B.60	0457600000	Q 4 SAK16	B.4	0468260801	DEK 6,5 FS 801-850	K.9	0473460851	DEK 5 FW 851-900	K.7
0446600000	VH 10/4/2.8 AKZ4	A.53	0457700000	Q 4 SAK16	I.9	0468260851	DEK 6,5 FS 851-900	K.9	0473460901	DEK 5 FW 901-950	K.7
0446600000	VH 10/4/2.8 AKZ4	B.58	0457700000	Q 4 SAK16	A.4	0468260901	DEK 6,5 FS 901-950	K.9	0473460951	DEK 5 FW 951-999	K.7
0446600000	VH 10/4/2.8 AKZ4	E.10	0457700000	Q 4 SAK16	C.3	0468260951	DEK 6,5 FS 951-999	K.9	0473560001	DEK 5 FS 1-50	K.7
0446600000	VH 10/4/2.8 AKZ4	A.51	0457700000	Q 4 SAK16	A.9	0468560000	DEK 6 NEUTRAL	K.8	0473560051	DEK 5 FS 51-100	K.7
0446600000	VH 10/4/2.8 AKZ4	A.56	0457700000	Q 4 SAK16	B.7	0468560000	DEK 6 NEUTRAL	K.9	0473560101	DEK 5 FS 101-150	K.7
0446600000	VH 10/4/2.8 AKZ4	A.55	0457800000	Q 10 SAK16	A.9	0468591686	DEK 6 RT NEUTRAL	K.9	0473560151	DEK 5 FS 151-200	K.7
0446600000	VH 10/4/2.8 AKZ4	E.12	0457800000	Q 10 SAK16	I.9	0468591687	DEK 6 GE NEUTRAL	K.8	0473560201	DEK 5 FS 201-250	K.7
0446600000	VH 10/4/2.8 AKZ4	B.56	0457800000	Q 10 SAK16	C.3	0468591688	DEK 6 GN NEUTRAL	K.8	0473560251	DEK 5 FS 251-300	K.7
0446600000	VH 10/4/2.8 AKZ4	A.50	0457800000	Q 10 SAK16	A.4	0468591689	DEK 6 V NEUTRAL	K.9	0473560301	DEK 5 FS 301-350	K.7
0446600000	VH 10/4/2.8 AKZ4	A.54	0457800000	Q 10 SAK16	B.4	0468591690	DEK 6 OR NEUTRAL	K.9	0473560351	DEK 5 FS 351-400	K.7
0446600000	VH 10/4/2.8 AKZ4	B.59	0457800000	Q 10 SAK16	B.7	0468591691	DEK 6 GR NEUTRAL	K.8	0473560401	DEK 5 FS 401-450	K.7
0446700000	VL 2 AKZ4/DK4	A.54	0459500000	ZBE 6	H.6	0468591692	DEK 6 BR NEUTRAL	K.8	0473560451	DEK 5 FS 451-500	K.7
0446700000	VL 2 AKZ4/DK4	E.11				0468591693	DEK 6 BL NEUTRAL	K.8	0473560501	DEK 5 FS 501-550	K.7
0446700000	VL 2 AKZ4/DK4	E.10				0468591694	DEK 6 SW NEUTRAL	K.9	0473560551	DEK 5 FS 551-600	K.7
0446700000	VL 2 AKZ4/DK4	B.60				0468660001	DEK 6 FW 1-50	K.8	0473560601	DEK 5 FS 601-650	K.7
0446700000	VL 2 AKZ4/DK4	E.12	0460020000	AP SAK4 KRG M.FU	I.6	0468660051	DEK 6 FW 51-100	K.8	0473560651	DEK 5 FS 651-700	K.7
0446700000	VL 2 AKZ4/DK4	A.56	0460360000	AST 3/35 6.3/2.8	A.36	0468660101	DEK 6 FW 101-150	K.8	0473560701	DEK 5 FS 701-750	K.7
0446700000	VL 2 AKZ4/DK4	A.55	0460460000	AST 4/35 SF 6.3/2.8	A.37	0468660151	DEK 6 FW 151-200	K.8	0473560751	DEK 5 FS 751-800	K.7
0446700000	VL 2 AKZ4/DK4	A.50	0460490000	AP SAK2.5/35 DB	I.6	0468660201	DEK 6 FW 201-250	K.8	0473560801	DEK 5 FS 801-850	K.7
0446700000	VL 2 AKZ4/DK4	B.59	0460560000	AP SAK2.5/35 + AST3+4	C.2	0468660251	DEK 6 FW 251-300	K.8	0473560851	DEK 5 FS 851-900	K.7
0446700000	VL 2 AKZ4/DK4	B.56	0460560000	AP SAK2.5/35 + AST3+4	A.37	0468660301	DEK 6 FW 301-350	K.8	0473560901	DEK 5 FS 901-950	K.7
0446700000	VL 2 AKZ4/DK4	A.51	0460560000	AP SAK2.5/35 + AST3+4	B.36	0468660351	DEK 6 FW 351-400	K.8	0473560951	DEK 5 FS 951-999	K.7
0446700000	VL 2 AKZ4/DK4	A.53	0460560000	AP SAK2.5/35 + AST3+4	I.6	0468660401	DEK 6 FW 401-450	K.8	0474360000	EK 2.5N	B.12
0446700000	VL 2 AKZ4/DK4	B.57	0460580000	AP SAK2.5/35 BL	I.6	0468660451	DEK 6 FW 451-500	K.8	0474460000	DK 4/32 LD ROT 24VDC A2	B.56
0446700000	VL 2 AKZ4/DK4	B.58	0460660001	DEK 5 FSZ 1-10	K.7	0468660501	DEK 6 FW 501-550	K.8	0474560000	ASK 1/EN	C.7
0446700000	VL 2 AKZ4/DK4	A.52	0460660011	DEK 5 FSZ 11-20	K.7	0468660551	DEK 6 FW 551-600	K.8	0474700000	TW AST1/PA HP/DBR/0.5	A.11
0447240000	AP ST5 PPO/SW	I.6	0460660021	DEK 5 FSZ 21-30	K.7	0468660601	DEK 6 FW 601-650	K.8	0474700000	TW AST1/PA HP/DBR/0.5	B.28
0447240000	AP ST5 PPO/SW	C.6	0460660031	DEK 5 FSZ 31-40	K.7	0468660651	DEK 6 FW 651-700	K.8	0474700000	TW AST1/PA HP/DBR/0.5	A.37
0447260000	AP ST5 PA/BE	I.6	0460660041	DEK 5 FSZ 41-50	K.7	0468660701	DEK 6 FW 701-750	K.8	0474700000	TW AST1/PA HP/DBR/0.5	B.41
0448360000	ST 5 PA/BE	C.6	0460660051	DEK 5 FSZ 51-60	K.7	0468660751	DEK 6 FW 751-800	K.8	0474700000	TW AST1/PA HP/DBR/0.5	B.32
0448460000	STL 5	C.6	0460660061	DEK 5 FSZ 61-70	K.7	0468660801	DEK 6 FW 801-850	K.8	0474700000	TW AST1/PA HP/DBR/0.5	A.33
			0460660071	DEK 5 FSZ 71-80	K.7	0468660851	DEK 6 FW 851-900	K.8	0474700000	TW AST1/PA HP/DBR/0.5	B.36
			0460660081	DEK 5 FSZ 81-90	K.7	0468660901	DEK 6 FW 901-950	K.8	0475360000	ZB 4K GE/GN	H.7
			0460660091	DEK 5 FSZ 91-100	K.7	0468660951	DEK 6 FW 951-999	K.8	0475380000	ZB 4K BL	H.7
0451300000	POSC M3X20 PAVNA	I.17	0461100000	QB 2 WI RA8 IS	E.6	0468760001	DEK 6 FS 1-50	K.8	0475460000	IK 4 GG ZB4	H.6
0456700000	Q 2 SAK6N	I.21	0461100000	QB 2 WI RA8 IS	C.7	0468760051	DEK 6 FS 51-100	K.8	0475480000	IK 4 BL ZB4	H.6
0456700000	Q 2 SAK6N	I.9	0461100000	QB 2 WI RA8 IS	B.21	0468760101	DEK 6 FS 101-150	K.8	0476260000	AP ADK1	I.6
0456700000	Q 2 SAK6N	A.8	0461100000	QB 2 WI RA8 IS	I.13	0468760151	DEK 6 FS 151-200	K.8	0476260000	AP ADK1	E.11
0456700000	Q 2 SAK6N	B.3	0461200000	QB 3 WI RA8 IS	E.6	0468760201	DEK 6 FS 201-250	K.8	0476520000	SAK 35/IK KRG	B.8
0456700000	Q 2 SAK6N	C.3	0461200000	QB 3 WI RA8 IS	C.7	0468760251	DEK 6 FS 251-300	K.8	0476560000	SAK 35/IK	B.5
0456700000	Q 2 SAK6N	A.3	0461200000	QB 3 WI RA8 IS	B.21	0468760301	DEK 6 FS 301-350	K.8	0477660000	TW ST5 PA/BE	C.6
0456700000	Q 2 SAK6N	B.7	0461200000	QB 3 WI RA8 IS	I.13	0468760351	DEK 6 FS 351-400	K.8	0478220000	AST 1 6.3/2.8 KRG	B.42
0456800000	Q 3 SAK6N	B.3	0461300000	QB 4 WI RA8 IS	E.6	0468760401	DEK 6 FS 401-450	K.8	0478260000	AST 1 6.3/2.8	B.36
0456800000	Q 3 SAK6N	I.9	0461300000	QB 4 WI RA8 IS	C.7	0468760451	DEK 6 FS 451-500	K.8	0479220000	AST 5 SF 6.3/2.8 KRG	B.43
0456800000	Q 3 SAK6N	A.3	0461300000	QB 4 WI RA8 IS	B.21	0468760501	DEK 6 FS 501-550	K.8	0479360000	AST 3/35 6.3	A.36
0456800000	Q 3 SAK6N	A.8	0461300000	QB 4 WI RA8 IS	I.13	0468760551	DEK 6 FS 551-600	K.8	0479460000	AST 4/35 SF 6.3	A.37
0456800000	Q 3 SAK6N	B.7	0462900000	H0,75/14 W	J.22	0468760601	DEK 6 FS 601-650	K.8	0479620000	SAK 4 SS 6.3/2.8 KRG	B.44
0456800000	Q 3 SAK6N	I.21	0463000000	H1,0/14 GE	J.22	0468760651	DEK 6 FS 651-700	K.8	0479660000	SAK 4 SS 6.3/2.8	B.37
0456800000	Q 3 SAK6N	C.3	0463100000	H1,5/14 R	J.22	0468760701	DEK 6 FS 701-750	K.8			
0456900000	Q 4 SAK6N	A.8	0464460000	SAKR LL	B.40	0468760751	DEK 6 FS 751-800	K.8			
0456900000	Q 4 SAK6N	I.21	0467400000	SAK 4/EN OR	I.7	0468760801	DEK 6 FS 801-850	K.8			
0456900000	Q 4 SAK6N	A.3	0467460000	SAK 4/EN	C.2	0468760851	DEK 6 FS 851-900	K.8	0482700000	QB 2 WI RA6 IS	B.40
0456900000	Q 4 SAK6N	B.3	0467480000	SAK 4/EN BL	I.7	0468760901	DEK 6 FS 901-950	K.8	0482700000	QB 2 WI RA6 IS	B.57
0456900000	Q 4 SAK6N	B.7	0467480000	SAK 4/EN BL	C.2	0468760951	DEK 6 FS 951-999	K.8	0482700000	QB 2 WI RA6 IS	B.58
0456900000	Q 4 SAK6N	C.3	0467960000	DK 4/32 1D CSA A2	B.59	0469360000	SAKR TS SE 1.6	B.39	0482700000	QB 2 WI RA6 IS	A.20
0456900000	Q 4 SAK6N	I.9	0468060000	DEK 6,5 NEUTRAL	K.9				0482700000	QB 2 WI RA6 IS	A.53
0457000000	Q 10 SAK6N	I.21	0468091686	DEK 6,5 RT NEUTRAL	K.9				0482700000	QB 2 WI RA6 IS	B.60
0457000000	Q 10 SAK6N	B.3	0468091687	DEK 6,5 GE NEUTRAL	K.9				0482700000	QB 2 WI RA6 IS	A.54
0457000000	Q 10 SAK6N	C.3	0468091688	DEK 6,5 GN NEUTRAL	K.9				0482700000	QB 2 WI RA6 IS	B.61
0457000000	Q 10 SAK6N	A.3	0468091689	DEK 6,5 VI NEUTRAL	K.9	0470300000	QL 2 SAK10	I.10	0482700000	QB 2 WI	

Order No.	Type	Page	Order No.	Type	Page	Order No.	Type	Page	Order No.	Type	Page
0482800000	QB 3 WI RA6 IS	B.16	0514500000	TS 35X7.5/LL 2M/ST/ZN	H.11	0522660052	DEK 5 GW 52	K.7	0522660152	DEK 5 GW 152	K.7
0482800000	QB 3 WI RA6 IS	B.38	0514510000	TS 35X7.5/LL 1M/ST/ZN	H.11	0522660053	DEK 5 GW 53	K.7	0522660153	DEK 5 GW 153	K.7
0482800000	QB 3 WI RA6 IS	B.17	0514570000	TS 35X7.5/LL/6 2M/ST/ZN	H.11	0522660054	DEK 5 GW 54	K.7	0522660154	DEK 5 GW 154	K.7
0482800000	QB 3 WI RA6 IS	A.55	0515300000	STR 7 F.SCHT 7	K.17	0522660055	DEK 5 GW 55	K.7	0522660155	DEK 5 GW 155	K.7
0482800000	QB 3 WI RA6 IS	A.20	0515300000	STR 7 F.SCHT 7	K.19	0522660056	DEK 5 GW 56	K.7	0522660156	DEK 5 GW 156	K.7
0482800000	QB 3 WI RA6 IS	B.40	0517960000	SCHT 7	K.17	0522660057	DEK 5 GW 57	K.7	0522660157	DEK 5 GW 157	K.7
0482800000	QB 3 WI RA6 IS	B.59	0518160000	SAKR LS 2STB	B.40	0522660058	DEK 5 GW 58	K.7	0522660158	DEK 5 GW 158	K.7
0482800000	QB 3 WI RA6 IS	A.50	0518200000	AD 4 SAK16	B.7	0522660059	DEK 5 GW 59	K.7	0522660159	DEK 5 GW 159	K.7
0482800000	QB 3 WI RA6 IS	A.18	0518200000	AD 4 SAK16	I.17	0522660060	DEK 5 GW 60	K.7	0522660160	DEK 5 GW 160	K.8
0482800000	QB 3 WI RA6 IS	A.56	0518200000	AD 4 SAK16	C.3	0522660061	DEK 5 GW 61	K.7	0522660161	DEK 5 GW 161	K.8
0482800000	QB 3 WI RA6 IS	B.58	0518200000	AD 4 SAK16	A.4	0522660062	DEK 5 GW 62	K.7	0522660162	DEK 5 GW 162	K.8
0482800000	QB 3 WI RA6 IS	A.54	0518200000	AD 4 SAK16	A.8	0522660063	DEK 5 GW 63	K.7	0522660163	DEK 5 GW 163	K.8
0482800000	QB 3 WI RA6 IS	A.53	0518960001	DEK 6 FWZ 11-10	K.9	0522660064	DEK 5 GW 64	K.7	0522660164	DEK 5 GW 164	K.8
0482800000	QB 3 WI RA6 IS	A.52	0518960011	DEK 6 FWZ 11-20	K.8	0522660065	DEK 5 GW 65	K.7	0522660165	DEK 5 GW 165	K.8
0482800000	QB 3 WI RA6 IS	A.51	0518960021	DEK 6 FWZ 21-30	K.8	0522660066	DEK 5 GW 66	K.7	0522660166	DEK 5 GW 166	K.8
0482800000	QB 3 WI RA6 IS	I.13	0518960031	DEK 6 FWZ 31-40	K.8	0522660067	DEK 5 GW 67	K.7	0522660167	DEK 5 GW 167	K.8
0482900000	QB 4 WI RA6 IS	A.53	0518960041	DEK 6 FWZ 41-50	K.8	0522660068	DEK 5 GW 68	K.7	0522660168	DEK 5 GW 168	K.8
0482900000	QB 4 WI RA6 IS	B.56	0518960051	DEK 6 FWZ 51-60	K.8	0522660069	DEK 5 GW 69	K.7	0522660169	DEK 5 GW 169	K.8
0482900000	QB 4 WI RA6 IS	A.54	0518960061	DEK 6 FWZ 61-70	K.8	0522660070	DEK 5 GW 70	K.7	0522660170	DEK 5 GW 170	K.8
0482900000	QB 4 WI RA6 IS	B.61	0518960071	DEK 6 FWZ 71-80	K.8	0522660071	DEK 5 GW 71	K.7	0522660171	DEK 5 GW 171	K.8
0482900000	QB 4 WI RA6 IS	B.58	0518960081	DEK 6 FWZ 81-90	K.8	0522660072	DEK 5 GW 72	K.7	0522660172	DEK 5 GW 172	K.8
0482900000	QB 4 WI RA6 IS	A.55	0518960091	DEK 6 FWZ 91-100	K.8	0522660073	DEK 5 GW 73	K.7	0522660173	DEK 5 GW 173	K.8
0482900000	QB 4 WI RA6 IS	B.59	0518960101	DEK 6 FWZ 101-110	K.8	0522660074	DEK 5 GW 74	K.7	0522660174	DEK 5 GW 174	K.8
0482900000	QB 4 WI RA6 IS	B.57	0518960111	DEK 6 FWZ 111-120	K.8	0522660075	DEK 5 GW 75	K.7	0522660175	DEK 5 GW 175	K.8
0482900000	QB 4 WI RA6 IS	A.52	0518960121	DEK 6 FWZ 121-130	K.8	0522660076	DEK 5 GW 76	K.7	0522660176	DEK 5 GW 176	K.8
0482900000	QB 4 WI RA6 IS	B.60	0518960131	DEK 6 FWZ 131-140	K.8	0522660077	DEK 5 GW 77	K.7	0522660177	DEK 5 GW 177	K.8
0482900000	QB 4 WI RA6 IS	A.50	0518960141	DEK 6 FWZ 141-150	K.8	0522660078	DEK 5 GW 78	K.7	0522660178	DEK 5 GW 178	K.8
0482900000	QB 4 WI RA6 IS	B.16	0518960151	DEK 6 FWZ 151-160	K.8	0522660079	DEK 5 GW 79	K.7	0522660179	DEK 5 GW 179	K.8
0482900000	QB 4 WI RA6 IS	B.40	0518960161	DEK 6 FWZ 161-170	K.8	0522660080	DEK 5 GW 80	K.7	0522660180	DEK 5 GW 180	K.8
0482900000	QB 4 WI RA6 IS	A.18	0518960171	DEK 6 FWZ 171-180	K.8	0522660081	DEK 5 GW 81	K.7	0522660181	DEK 5 GW 181	K.8
0482900000	QB 4 WI RA6 IS	A.51	0518960181	DEK 6 FWZ 181-190	K.8	0522660082	DEK 5 GW 82	K.7	0522660182	DEK 5 GW 182	K.8
0482900000	QB 4 WI RA6 IS	B.39	0518960191	DEK 6 FWZ 191-200	K.8	0522660083	DEK 5 GW 83	K.7	0522660183	DEK 5 GW 183	K.8
0482900000	QB 4 WI RA6 IS	B.38	0518960201	DEK 6 FWZ 201-210	K.8	0522660084	DEK 5 GW 84	K.7	0522660184	DEK 5 GW 184	K.8
0482900000	QB 4 WI RA6 IS	A.19	0519060001	DEK 6,5 FWZ 1-10	K.9	0522660085	DEK 5 GW 85	K.7	0522660185	DEK 5 GW 185	K.8
0482900000	QB 4 WI RA6 IS	B.17	0519060011	DEK 6,5 FWZ 11-20	K.9	0522660086	DEK 5 GW 86	K.7	0522660186	DEK 5 GW 186	K.8
0482900000	QB 4 WI RA6 IS	A.56	0519060021	DEK 6,5 FWZ 21-30	K.9	0522660087	DEK 5 GW 87	K.7	0522660187	DEK 5 GW 187	K.8
0482900000	QB 4 WI RA6 IS	A.20	0519060031	DEK 6,5 FWZ 31-40	K.9	0522660088	DEK 5 GW 88	K.7	0522660188	DEK 5 GW 188	K.8
0482900000	QB 4 WI RA6 IS	I.13	0519060041	DEK 6,5 FWZ 41-50	K.9	0522660089	DEK 5 GW 89	K.7	0522660189	DEK 5 GW 189	K.8
0483460000	AP TOP4SF-FF	I.4	0519060051	DEK 6,5 FWZ 51-60	K.9	0522660090	DEK 5 GW 90	K.7	0522660190	DEK 5 GW 190	K.8
0483460000	AP TOP4SF-FF	I.6	0519060061	DEK 6,5 FWZ 61-70	K.9	0522660091	DEK 5 GW 91	K.7	0522660191	DEK 5 GW 191	K.8
0484060000	DK 4/32 1D CSA A1	B.58	0519060071	DEK 6,5 FWZ 71-80	K.9	0522660092	DEK 5 GW 92	K.7	0522660192	DEK 5 GW 192	K.8
0485100000	IS 4 DIN 6911	J.20	0519060081	DEK 6,5 FWZ 81-90	K.9	0522660093	DEK 5 GW 93	K.7	0522660193	DEK 5 GW 193	K.8
0485200000	ADP 1/HP1 1M	I.16	0519060091	DEK 6,5 FWZ 91-100	K.9	0522660094	DEK 5 GW 94	K.7	0522660194	DEK 5 GW 194	K.8
0485300000	ADP 2/HP2 1M	I.16				0522660095	DEK 5 GW 95	K.7	0522660195	DEK 5 GW 195	K.8
0485300000	ADP 2/HP2 1M	A.11				0522660096	DEK 5 GW 96	K.7	0522660196	DEK 5 GW 196	K.8
0485400000	ADP 3/HP3 1M	A.10				0522660097	DEK 5 GW 97	K.7	0522660197	DEK 5 GW 197	K.8
0485400000	ADP 3/HP3 1M	I.16	0522361075	DEK 5 GW L1	K.8	0522660098	DEK 5 GW 98	K.7	0522660198	DEK 5 GW 198	K.8
0485560000	HP 1 ADP1	I.16	0522361076	DEK 5 GW L2	K.8	0522660099	DEK 5 GW 99	K.7	0522660199	DEK 5 GW 199	K.8
0485560000	HP 2 ADP2	I.16	0522361077	DEK 5 GW L3	K.8	0522660100	DEK 5 GW 100	K.7	0522660200	DEK 5 GW 200	K.8
0485760000	HP 3 ADP3	I.16	0522860001	DEK 5 GW 1	K.7	0522660101	DEK 5 GW 101	K.7	0522761021	DEK 5 GW A	K.8
0485860000	HP 4 ADP3	I.16	0522860002	DEK 5 GW 2	K.7	0522660102	DEK 5 GW 102	K.7	0522761022	DEK 5 GW B	K.8
			0522860003	DEK 5 GW 3	K.7	0522660103	DEK 5 GW 103	K.7	0522761023	DEK 5 GW C	K.8
			0522860004	DEK 5 GW 4	K.7	0522660104	DEK 5 GW 104	K.7	0522761024	DEK 5 GW D	K.8
			0522860005	DEK 5 GW 5	K.7	0522660105	DEK 5 GW 105	K.7	0522761025	DEK 5 GW E	K.8
			0522860006	DEK 5 GW 6	K.7	0522660106	DEK 5 GW 106	K.7	0522761026	DEK 5 GW F	K.8
			0522860007	DEK 5 GW 7	K.7	0522660107	DEK 5 GW 107	K.7	0522761027	DEK 5 GW G	K.8
			0522860008	DEK 5 GW 8	K.7	0522660108	DEK 5 GW 108	K.7	0522761028	DEK 5 GW H	K.8
			0522860009	DEK 5 GW 9	K.7	0522660109	DEK 5 GW 109	K.7	0522761029	DEK 5 GW I	K.8
			0522860010	DEK 5 GW 10	K.7	0522660110	DEK 5 GW 110	K.7	0522761030	DEK 5 GW J	K.8
			0522860011	DEK 5 GW 11	K.7	0522660111	DEK 5 GW 111	K.7	0522761031	DEK 5 GW K	K.8
			0522860012	DEK 5 GW 12	K.7	0522660112	DEK 5 GW 112	K.7	0522761032	DEK 5 GW L	K.8
			0522860013	DEK 5 GW 13	K.7	0522660113	DEK 5 GW 113	K.7	0522761033	DEK 5 GW M	K.8
			0522860014	DEK 5 GW 14	K.7	0522660114	DEK 5 GW 114	K.7	0522761034	DEK 5 GW N	K.8
			0522860015	DEK 5 GW 15	K.7	0522660115	DEK 5 GW 115	K.7	0522761035	DEK 5 GW O	K.8
			0522860016	DEK 5 GW 16	K.7	0522660116	DEK 5 GW 116	K.7	0522761036	DEK 5 GW P	K.8
			0522860017	DEK 5 GW 17	K.7	0522660117	DEK 5 GW 117	K.7	0522761037	DEK 5 GW Q	K.8
			0522860018	DEK 5 GW 18	K.7	0522660118	DEK 5 GW 118	K.7	0522761038	DEK 5 GW R	K.8
			0522860019	DEK 5 GW 19	K.7	0522660119	DEK 5 GW 119	K.7	0522761039	DEK 5 GW S	K.8
			0522860020	DEK 5 GW 20	K.7	0522660120	DEK 5 GW 120	K.7	0522761040	DEK 5 GW T	K.8
			0522860021	DEK 5 GW 21	K.7	0522660121	DEK 5 GW 121	K.7	0522761041	DEK 5 GW U	K.8
			0522860022	DEK 5 GW 22	K.7	0522660122	DEK 5 GW 122	K.7	0522761042	DEK 5 GW V	K.8
			0522860023	DEK 5 GW 23	K.7	0522660123	DEK 5 GW 123	K.7	0522761043	DEK 5 GW W	K.8
			0522860024	DEK 5 GW 24	K.7	0522660124	DEK 5 GW 124	K.7	0522761044	DEK 5 GW X	K.8
			0522860025	DEK 5 GW 25	K.7	0522660125	DEK 5 GW 125	K.7	0522761045	DEK 5 GW Y	K.8
			0522860026	DEK 5 GW 26	K.7	0522660126	DEK 5 GW 126	K.7	0522761046	DEK 5 GW Z	K.8
			0522860027	DEK 5 GW 27	K.7	0522660127	DEK 5 GW 127	K.7	0522861047	DEK 5 GW A KLEIN	K.8
			0522860028	DEK 5 GW 28	K.7	0522660128	DEK 5 GW 128	K.7	0522861048	DEK 5 GW B KLEIN	K.8
			0522860029	DEK 5 GW 29	K.7	0522660129	DEK 5 GW 129	K.7	0522861049	DEK 5 GW C KLEIN	K.8
			0522860030	DEK 5 GW 30	K.7	0522660130	DEK 5 GW 130	K.7	0522861050	DEK 5 GW D KLEIN	K.8
			0522860031	DEK 5 GW 31	K.7	0522660131	DEK 5 GW 131	K.7	0522861051	DEK 5 GW E KLEIN	K.8

Order No.	Type	Page	Order No.	Type	Page	Order No.	Type	Page	Order No.	Type	Page
0522861072	DEK 5 GW Z KLEIN	K.8	0526960077	DEK 6 GW 77	K.9	0564900000	QL 2 SAK35N	A.5	0630200000	KISC M5X50/26 SAK95	I.9
0523060001	DEK 5 FWZ 1-10	K.7	0526960078	DEK 6 GW 78	K.9	0565000000	QL 3 SAK35N	B.9	0630360000	SAK 4 S/35 6.3/2.8	A.37
0523060011	DEK 5 FWZ 11-20	K.7	0526960079	DEK 6 GW 79	K.9	0565000000	QL 3 SAK35N	A.5	0630460000	SAK 4 SS/35 6.3/2.8	A.38
0523060021	DEK 5 FWZ 21-30	K.7	0526960080	DEK 6 GW 80	K.9	0565000000	QL 3 SAK35N	I.9	0631260000	DK 4S SF 6.3/2.8	B.37
0523060031	DEK 5 FWZ 31-40	K.7	0526960081	DEK 6 GW 81	K.9	0565000000	QL 3 SAK35N	B.5	0631300000	AP DK4Q DB	I.6
0523060041	DEK 5 FWZ 41-50	K.7	0526960082	DEK 6 GW 82	K.9	0565000000	QL 3 SAK35N	A.9	0631360000	AP DK4S	I.6
0523060051	DEK 5 FWZ 51-60	K.7	0526960083	DEK 6 GW 83	K.9	0565100000	QL 4 SAK35N	B.5	0631360000	AP DK4S	A.38
0523060061	DEK 5 FWZ 61-70	K.7	0526960084	DEK 6 GW 84	K.9	0565100000	QL 4 SAK35N	B.9	0631360000	AP DK4S	B.37
0523060071	DEK 5 FWZ 71-80	K.7	0526960085	DEK 6 GW 85	K.9	0565100000	QL 4 SAK35N	A.9	0631360000	AP DK4S	A.39
0523060081	DEK 5 FWZ 81-90	K.7	0526960086	DEK 6 GW 86	K.9	0565100000	QL 4 SAK35N	A.5	0631380000	AP DK4S BL	I.6
0523060091	DEK 5 FWZ 91-100	K.7	0526960087	DEK 6 GW 87	K.9	0565100000	QL 4 SAK35N	I.9	0631860000	DEK 6 FWZ R,S,T,N,ERDE	K.8
0523760000	DK 4/32 2D CSA A2	B.59	0526960088	DEK 6 GW 88	K.9	0565200000	QL 10 SAK35N	B.9	0631961187	DEK 6 FWZ L1-PE	K.8
0525500000	GZ 1.0A/F	B.26	0526960089	DEK 6 GW 89	K.9	0565200000	QL 10 SAK35N	A.5	0631961203	DEK 6 FWZ L1-ERDE LKRE	K.8
0525500000	GZ 1.0A/F	A.23	0526960090	DEK 6 GW 90	K.9	0565200000	QL 10 SAK35N	B.5	0632060000	DEK 6,5 FWZ R,S,T,N,ERD	K.9
0525500000	GZ 1.0A/F	A.28	0526960091	DEK 6 GW 91	K.9	0565200000	QL 10 SAK35N	A.9	0632161187	DEK 6,5 FW L1-PE	K.9
0525910000	ZBE 6K SW	H.7	0526960092	DEK 6 GW 92	K.9	0565200000	QL 10 SAK35N	I.9	0632161203	DEK 6,5 FW L1-ERDE L.KR	K.9
0525960000	ZBE 6K GE/GN	H.7	0526960093	DEK 6 GW 93	K.9	0565460000	ZB 4/6K GE/GN	H.7	0632560000	DEK 6 FW L.N,PE	K.8
0525980000	ZBE 6K BL	H.7	0526960094	DEK 6 GW 94	K.9	0565480000	ZB 4/6K BL	H.7	0634100000	AD 250	I.18
0526060000	IK 6 GG ZBE6K	H.6	0526960095	DEK 6 GW 95	K.9	0565600000	H1,5/24 R	J.22	0634300000	HP EK132/2 AD250	I.18
0526080000	IK 6 BL ZBE6K	H.6	0526960096	DEK 6 GW 96	K.9	0565700000	H6,0/26 SW	J.22	0635060000	AP DKIT4	I.6
0526400000		I.13	0526960097	DEK 6 GW 97	K.9	0565800000	H10,0/28 EB	J.22	0635100000	H1,5/16 R	J.22
0526700000	ISPF QB75 SW	I.13	0526960098	DEK 6 GW 98	K.9	0565900000	H16,0/28 GN	J.22	0635960000	KLBUE SH1	H.4
0526760000	ISPF QB75 RT	I.13	0526960099	DEK 6 GW 99	K.9	0566000000	H16,0/28 GN	J.22	0636620000	SAKG 70/35 II/GW	A.44
0526780000	ISPF QB75 BL	I.13	0526960100	DEK 6 GW 100	K.9	0566700000	BEZ.-KARTE ADP	I.16	0636800000	FM 5/TS35	H.15
0526960001	DEK 6 GW 1	K.8	0526960200	DEK 6 GW 200	K.8	0567260000	SAK 2,5/35 LL	A.40	0636900000	FM 6/TS35	H.15
0526960002	DEK 6 GW 2	K.8	0526961000	DEK 6 GW 0	K.8	0567300000	PZ 3	J.7	0637120000	SAKG 32/35 I	A.42
0526960003	DEK 6 GW 3	K.8	0527680000	DK 4/35	A.12	0567300000	PZ 3	J.35	0637220000	SAKG 32/35 III	A.44
0526960004	DEK 6 GW 4	K.8	0527680000	DK 4/35 BL	A.12	0569560000	DK 4/32 GL 100K 115VAC	B.57	0637320000	SAKG 32/35 II	A.43
0526960005	DEK 6 GW 5	K.8	0528400000	VL 2 RSF 1+2	B.28	0569660000	ZB 16/6K GE/GN	H.7	0637420000	SAKG 32/35 II/GW	A.43
0526960006	DEK 6 GW 6	K.8	0530000000			0570000000			0637520000	SAKG 40/35 I	A.45
0526960007	DEK 6 GW 7	K.8	0531760000	SSP 3 SAKT1	A.33	0571200000	SSCH 6X6X1000 MS/BK	H.3	0637620000	SAKG 40/35 III	A.46
0526960008	DEK 6 GW 8	K.8	0531760000	SSP 3 SAKT1	B.31	0571300000	SSCH 6X6X1000 CU/SN	H.3	0637720000	SAKG 40/35 II/GW	A.45
0526960009	DEK 6 GW 9	K.8	0531760000	SSP 3 SAKT1	A.32	0572600000	DEK 5 GW	K.7	0637920000	SAKG 46/35 II	A.46
0526960010	DEK 6 GW 10	K.8	0531760000	SSP 3 SAKT1	I.20	057261198	DEK 5 GW +	K.8	0638020000	SAKG 46/35 II/GW	A.47
0526960011	DEK 6 GW 11	K.8	0531760000	SSP 3 SAKT1	B.32	0572621199	DEK 5 GW -	K.8	0638120000	SAKG 54/35 II	A.47
0526960012	DEK 6 GW 12	K.8	0532960000	AP DSK1.5	I.6	0572621202	DEK 5 GW ERDE	K.8	0638220000	SAKG 54/35 II/GW	A.47
0526960013	DEK 6 GW 13	K.8	0533500000	H6,0/20 SW	J.22	0572621203	DEK 5 GW ERDE I.KR.	K.8	0640000000		
0526960014	DEK 6 GW 14	K.8	0533800000	GZ 0.5A/F	A.28	0572621215	DEK 5 GW W-STROM	K.8	0641720000	SH 2 S	H.4
0526960015	DEK 6 GW 15	K.8	0533800000	GZ 0.5A/F	B.26	0572621215	DEK 5 GW W-STROM	K.8	0642600000	FKSC M6X8 D9/SW3	H.14
0526960016	DEK 6 GW 16	K.8	0534380000	GZ 0.5A/F	B.26	05726291737	DEK 5 GW RT/SW +	K.8	0642760000	DK 4/32 2D CSA GET.SCH.	B.59
0526960017	DEK 6 GW 17	K.8	0534380000	GZ 0.5A/F	J.22	05726291741	DEK 5 GW BL/SW -	A.9	0642820000	MOFU 35/LO/1	H.15
0526960018	DEK 6 GW 18	K.8	0534200000	H10,0/22 EB	I.13	0576700000	AD 4 SAK35N	I.17	0646400000	G 25/0.80A/M GR	A.28
0526960019	DEK 6 GW 19	K.8	0535200000		A.16	0576700000	AD 4 SAK35N	A.5	0646400000	G 25/0.80A/M GR	B.26
0526960020	DEK 6 GW 20	K.8	0535300000	EK 95/35/1ZB BK	I.14	0576700000	AD 4 SAK35N	B.9	0646560000	DK 4/32 LD GR 24VDC A2	B.56
0526960021	DEK 6 GW 21	K.8	0535860000	TA 1	B.38	0576700000	AD 4 SAK35N	B.9	0646930000	SAK 4 SS/35 6.3 GR	I.7
0526960022	DEK 6 GW 22	K.8	0536560000	DK 4 SW 1X1	K.8	0580000000			0660000000		
0526960023	DEK 6 GW 23	K.8	0537261187	DEK 5 GW PE	K.8	0582360002	DEK 5 FSZ 2,4,6...16	K.7	0661060000	EK 2.5/35	A.14
0526960024	DEK 6 GW 24	K.8	0537261188	DEK 5 GW PEN	K.8	0582360018	DEK 5 FSZ 18,20,...32	K.7	0661160000	EK 4/35	A.14
0526960025	DEK 6 GW 25	K.8	0537261235	DEK 5 GW MP	K.8	0582460000	SAK 35/35/K	A.5	0661260000	EK 6/35	A.15
0526960026	DEK 6 GW 26	K.8	0538960000	DK 4/35 1D A2	A.54	0582560000		I.4	0661360000	EK 10/35	A.15
0526960027	DEK 6 GW 27	K.8	0538960000	DK 4/35 1D A1	A.53	0590000000			0661460000	EK 35/35	A.16
0526960028	DEK 6 GW 28	K.8	0538980000	DK 4/35 1D A1 BL	A.53	0590060000	DK 4Q/32	B.10	0662220000	SAK 95/35 KRG	A.10
0526960029	DEK 6 GW 29	K.8	0540000000			0590000000			0662270000	SAK 95/35 KRG/BL	I.7
0526960030	DEK 6 GW 30	K.8	0542500000	H0,75/10	J.33	0590080000	DK 4Q/32 BL	B.10	0663960000	DK 4/32 2D A1	B.60
0526960031	DEK 6 GW 31	K.8	0544120000	SAK 2.5 LS KRG	B.45	0590160000	DK 4Q/35	A.12	0664600000	DMS 2 Set	J.11
0526960032	DEK 6 GW 32	K.8	0544660000	DK 4/32 1D CSA GET.SCH.	B.58	0590180000	DK 4Q/35 BL	A.12	0664860000	AST 1/35 6.3	A.36
0526960033	DEK 6 GW 33	K.8	0545300000		I.13	0590260000	DK 4QV/32	B.11	0664960000	AST 5/35 SF 6.3/2.8	A.37
0526960034	DEK 6 GW 34	K.8	0545400000		I.13	0590280000	DK 4QV/32 BL	B.11	0667520000	SAKS 3/35 GZ/6.3X32	A.25
0526960035	DEK 6 GW 35	K.8	0546000000	ISPF QB58 SW	K.8	0600000000			0680000000		
0526960036	DEK 6 GW 36	K.8	0546040000	ISPF QB58 RT	K.8	0607000000	TW SAKS2 HP/DBR/2	B.36	0685260000	DK 4/32 1D 1K5	B.60
0526960037	DEK 6 GW 37	K.8	0546080000	ISPF QB58 BL	K.8	0607000000	TW SAKS2 HP/DBR/2	A.36	0686660000	DK 4S/35 SF 6.3/2.8	A.39
0526960039	DEK 6 GW 39	K.8	0546900000	G 25/0.25A/M GE	B.26	0607000000	TW SAKS2 HP/DBR/2	B.40	0687360000	DKT 4	B.17
0526960040	DEK 6 GW 40	K.8	0546900000	G 25/0.25A/M GE	A.28	0607000000	TW SAKS2 HP/DBR/2	B.42	0687460000	DKT 4/35	A.19
0526960041	DEK 6 GW 41	K.8	0550000000			0590000000			0687560000	AP DKT4 PA	B.61
0526960042	DEK 6 GW 42	K.8	0550420000	SAKT 1/DU2	B.31	0590080000	DK 4Q/32 BL	B.10	0687560000	AP DKT4 PA	I.6
0526960043	DEK 6 GW 43	K.8	0550520000	SAK 95 KRG	B.9	0590160000	DK 4Q/35	A.12	0687560000	AP DKT4 PA	A.19
0526960044	DEK 6 GW 44	K.8	0550620000	SAK 35N KRG	B.9	0590180000	DK 4Q/35 BL	A.12	0687560000	AP DKT4 PA	A.19
0526960045	DEK 6 GW 45	K.8	0550660000	SAK 35N	B.5	0590260000	DK 4QV/32	B.11	0687560000	AP DKT4 PA	A.19
0526960046	DEK 6 GW 46	K.8	0550920000	AP SAK95 KRG	I.4	0590280000	DK 4QV/32 BL	B.11	0687560000	AP DKT4 PA	A.19
0526960047	DEK 6 GW 47	K.8	0550920000	AP SAK95 KRG	I.6	0600000000			0687560000	AP DKT4 PA	A.19
0526960048	DEK 6 GW 48	K.8	0550920000	AP SAK95 KRG	B.9	0607000000	TW SAKS2 HP/DBR/2	B.36	0687900000	FM 4/TS35	G.10
0526960049	DEK 6 GW 49	K.8	0550920000	AP SAK95 KRG	A.10	0607000000	TW SAKS2 HP/DBR/2	B.39	0687900000	FM 4/TS35	H.15
0526960050	DEK 6 GW 50	K.8	0550920000	AP SAK95 KRG	I.6	0607000000	TW SAKS2 HP/DBR/2	B.45	0688660000	DEK 6 FW 1-5 (10X)	K.8
0526960051	DEK 6 GW 51	K.8	0550920000	AP SAK95 KRG	A.10	0608220000	SAK 35N/35 KRG	A.9	0690000000		
0526960052	DEK 6 GW 52	K.8	0550920000	AP SAK95 KRG	I.6	0608220000	SAK 35N/35 KRG	A.5	0690700000	H0,5/14 OR	J.22
0526960053	DEK 6 GW 53	K.8	0550920000	AP SAK95 KRG/BL	I.9	0608320000	SAK 35N/35/K KRG	A.9	0692160000	DK 4/32 RC 220R/220NF	B.61
0526960054	DEK 6 GW 54	K.8	0551100000	VH 35/11/5.5 SAK95	A.10	0608360000	SAK 35N/35/K KRG	A.5	0697160000	AKZ 2.5	E.2
0526960055	DEK 6 GW 55	K.8	0551100000	VH 35/11/5.5 SAK95	I.9	0608360000	SAK 35N/35/K KRG	A.5	0697180000	AKZ 2.5 BL	E.2
0526960056	DEK 6 GW 56	K.8	0551200000	QL 2 SAKG28	A.10	0608360000	SAK 35N/35/K KRG	A.9	0697260000	AP AKZ2.5K	E.13
0526960057	DEK 6 GW 57	K.8	0551200000	QL 2 SAKG28	B.47	0608360000	SAK 35N/35/K KRG	A.9	0697260000	AP AKZ2.5K	I.6
0526960058	DEK 6 GW 58	K.8	0551200000	QL 2 SAKG28	B.9	0608360000	SAK 35N/35/K KRG	A.9	0697360000	AP AKZ2.5	I.6
0526960059	DEK 6 GW 59	K.8	0551200000	QL 2 SAKG28	A.10	0608360000	SAK 35N/35/K KRG	A.9	0697360000	AP AKZ2.5	E.2
0526960060	DEK 6 GW 60	K.8	0551200000	QL 2 SAKG28	B.47	0620220000	MK 6/4	A.23	0697380000	AP AKZ2.5 BL	I.6
0526960061	DEK 6 GW 61	K.8	0551200000	QL 2 SAKG28	B.9	0620320000	MK 6/3	H.15	0697380000	AP AKZ2.5 BL	E.2
0526960062	DEK 6 GW 62	K.8	0551200000	QL 2 SAKG28</							

Order No.	Type	Page
101000000		
1011320000	DEK 5/6 PLUS MC NIE WS	K.11
1011440000	PLOTTERPEN 0,7	K.25
1011440000	PLOTTERPEN 0,7	K.24
1011450000	PLOTTER PEN 0.70 P-INK	K.24
1011450000	PLOTTER PEN 0.70 P-INK	K.25
102000000		
1024050000	PRINTJET PRO 115V	K.22
1025680000	DEK 5/30 MC SDR	K.11
1027040000	PJ PRO TINTK INK K	K.22
1027050000	PJ PRO TINTK INK C	K.22
1027060000	PJ PRO TINTK INK M	K.22
1027070000	PJ PRO TINTK INK Y	K.22
1027080000	PJ PRO TINTK FL	K.22
1027090000	PJ PRO TINTK INK SET BK	K.22
1027110000	PJ-PRO TINTK INK SET COL	K.22
105000000		
1050760000	WGB 5 ABDG.M.GRUPPENBEZ	K.18
1050960000	WGB 8 ABDG.M.GRUPPENBEZ	K.18
1053460000	WAD 5 M. BL.	K.18
1053560000	WAD 8 M. BL.	K.18
1055960000	WAD 12 M. BL.	K.18
1056060000	WAD 5 NEUTRAL	K.18
1056160000	WAD 8 NEUTRAL	K.18
1056260000	WAD 12 NEUTRAL	K.18
1058800000	WTW EN	A.12
1058800000	WTW EN	B.10
1058800000	WTW EN	A.13
1058800000	WTW EN	A.34
1058800000	WTW EN	B.11
1058800000	WTW EN	B.34
1059000000	WEW 35/1	H.5
106000000		
1061200000	WEW 35/2	H.13
1061200000	WEW 35/2	H.5
1062860000	WAD 27 M. BL.	K.18
1062960000	WAD 27 NEUTRAL	K.18
1067600000	WEW 32/1	H.13
1068700000	WSH 1	G.6
107000000		
1071900000	EW 15/2	H.13
1079900000	WSH 4 MT	G.9
108000000		
1080100000	WSH 5	G.6
1080200000	WSH 6	G.6
1082400000	BFEH 1/WSH	G.7
1083100000	WSH 18 MT	G.7
1083200000	WSH 19 MT	G.7
1083900000	SMSE WSH U1	G.7
110000000		
1104700000	SAKH 10 CUN/EP/WSH	D.7
111000000		
1111160000	DK 4/35 GL 1D 11,0A	A.52
1111320000	SAKS 1/35 G20 LD 24VAC	A.24
116000000		
1166820000	SAKT E/35 2LD 30VAC	A.57
126000000		
1261300000	ZB 10 F,10X3/10X5/10X10	H.6
1266380000	HP NT16/10X3	A.31
1269600000	SCHT 14/6	K.18
127000000		
1272420000	SAKT 4/35/LT O.STB	A.33
1272520000	SAKT 4/35/LT STB2.0	A.33
1276300000	FZS 2/4 RT/80 SAKT4	L.14
1276960001	DEK 8 FWZ 1-10	K.9
1276960011	DEK 8 FWZ 11-20	K.9
1276960021	DEK 8 FWZ 21-30	K.9
1276960031	DEK 8 FWZ 31-40	K.9
1276960041	DEK 8 FWZ 41-50	K.9
1276960051	DEK 8 FWZ 51-60	K.9
1276960061	DEK 8 FWZ 61-70	K.9
1276960071	DEK 8 FWZ 71-80	K.9
1276960081	DEK 8 FWZ 81-90	K.9
1276960091	DEK 8 FWZ 91-100	K.9
1276960101	DEK 8 FWZ 101-110	K.9
1276960111	DEK 8 FWZ 111-120	K.9
1276960121	DEK 8 FWZ 121-130	K.9
1276960131	DEK 8 FWZ 131-140	K.9
1276960141	DEK 8 FWZ 141-150	K.9

Order No.	Type	Page
1277060000	DEK 8 NEUTRAL	K.9
1277091686	DEK 8 RT NEUTRAL	K.9
1277091687	DEK 8 GE NEUTRAL	K.9
1277091688	DEK 8 GN NEUTRAL	K.9
1277091689	DEK 8 VI NEUTRAL	K.9
1277091690	DEK 8 OR NEUTRAL	K.9
1278460000	SCHT 9/4	K.18
128000000		
1284060000	DK 4Q/35/TC TYP J	A.34
1284160000	DK 4Q/35/TC TYP K	A.34
1285660000	DK 4Q/35/TC TYP T	A.34
1286600000	TST 2/M5	H.14
1287700000	BST 2 BEZEICHNUNGSSTR.	L.17
1287860000	TBS 2	L.17
1288300000	REINIGUNGSBECHER	K.24
1289660001	DEK 8 FSZ 1-10	K.9
1289660011	DEK 8 FSZ 11-20	K.9
1289660021	DEK 8 FSZ 21-30	K.9
1289660031	DEK 8 FSZ 31-40	K.9
1289660041	DEK 8 FSZ 41-50	K.9
1289660051	DEK 8 FSZ 51-60	K.9
1289660061	DEK 8 FSZ 61-70	K.9
1289660071	DEK 8 FSZ 71-80	K.9
1289660081	DEK 8 FSZ 81-90	K.9
1289660091	DEK 8 FSZ 91-100	K.9
1289690000	DEK 8 BEDR./FARBIG	K.9
130000000		
1303360000	AKE 2.5	E.4
1304860000	DKT 4V 2STB	B.17
1304960000	DKT 4V/35 2STB	A.19
131000000		
1312500000	Q 2 DLJ	L.11
1312600000	Q 3 DLJ	L.11
1312700000	Q 4 DLJ	L.11
1313100000	Q 10 DLJ	L.11
1313260000	AP DLJ2.5	L.6
1317660000	AP DLJ2.5	L.6
1317800000	AP DLD.2.5 BL	L.6
1318061187	DEK 6 GW PE	K.9
1318061198	DEK 6 GW +	K.9
1318061199	DEK 6 GW -	K.9
1318061202	DEK 6 GW ERDE	K.9
1318061203	DEK 6 GW ERDE L.KR.	K.9
1318091737	DEK 6 GW RT/WSW +	K.9
1318091741	DEK 6 GW BL/WSW -	K.9
1319260000	QVS 2/4 SAKT4	B.32
1319260000	QVS 2/4 SAKT4	A.33
1319360000	SSP 4 SAKT4	L.20
1319360000	SSP 4 SAKT4	A.33
1319360000	SSP 4 SAKT4	B.32
1319900000	BFSC M3X22 SAKT4	A.33
1319900000	BFSC M3X22 SAKT4	B.32
132000000		
1323860000	SAK 4/35 OR	L.7
1326360000	SAK 2.5 OR	L.7
1326660000	DEK 8 SONDERDR. WEISS	K.9
1326690000	DEK 8 SONDERDR. FARBIG	K.9
133000000		
1333100000	H2,5/14S BL	J.32
1333200000	AP TW/SS.../35	L.6
1338060000	DK 4Q/TC TYP J	B.34
1338160000	DK 4Q/TC TYP T	B.34
1338260000	DK 4Q/TC TYP K	B.34
1338300000	EK 70/35/M.2ZB O.IK	A.17
135000000		
1358460000	DEK 5 FW 1,3,5,...99	K.7
1358560000	DEK 5 FW 2,4,...100	K.7
1358660000	DEK 6 FW 1,3,5,...99	K.8
1358760000	DEK 6 FW 2,4,...100	K.8
136000000		
1368720000	SAKS 2/35	A.26
137000000		
1378160000	ADP 4/300	L.16
138000000		
1381600000	EP 1/BW SAKG32/35 HP/DB	L.5
139000000		
1397160000	AP DK4Q	B.11
1397160000	AP DK4Q	A.12
1397160000	AP DK4Q	A.13
1397160000	AP DK4Q	B.10

Order No.	Type	Page
1397160000	AP DK4Q	B.34
1397160000	AP DK4Q	L.6
1397160000	AP DK4Q	A.34
1397180000	AP DK4Q BL	L.6
1397180000	AP DK4Q BL	A.12
1397180000	AP DK4Q BL	B.10
1397180000	AP DK4Q BL	B.11
1397180000	AP DK4Q BL	A.13
140000000		
1404520000	SAKC 10/35 1STB4 KRg	A.20
143000000		
1430760000	ADP 4/1000	L.16
144000000		
1443000000		L.10
146000000		
1461960000	SAKR OR	L.7
157000000		
1572000000	DEK 5 FWZ 1-9	K.7
159000000		
1592810000	KLBU 4-13.5	G.4
1595960000	AP DLD2.5/PE	L.6
1596240000	SAKH 35 EP/WSW	D.7
1596240000	SAKH 35 EP/WSW	L.7
1598080000	SAKK 4 KER/WS	D.2
1598090000	SAKK 10 KER/WS	D.3
160000000		
1600480000	KLBU 3-8	G.4
1600490000	KLBU 10-20	G.4
1607710000	ESO 5 DIN A4 WEISS BOG.	K.17
1607720000	ESO 7 A4-BOGEN WEISS	K.17
1607720000	ESO 7 A4-BOGEN WEISS	K.19
1609801044	DEK 5/5 MC-10 NEUT. WS	K.11
1609801044	DEK 5/5 MC-10 NEUT. WS	K.19
1609801044	DEK 5/5 MC-10 NEUT. WS	K.18
1609801044	DEK 5/5 MC-10 NEUT. WS	K.17
1609801044	DEK 5/5 MC-10 NEUT. WS	K.16
1609801686	DEK 5/5 MC-10 NEUT. RT	K.11
1609801687	DEK 5/5 MC-10 NEUT. GE	K.11
1609801688	DEK 5/5 MC-10 NEUT. GN	K.11
1609801691	DEK 5/5 MC-10 NEUT. GR	K.11
1609801693	DEK 5/5 MC-10 NEUT. BL	K.11
1609810000	DEK 5/5 MC BEDRUCKT	K.11
1609820000	DEK 5/6 MC NEUTRAL	K.11
1609830000	DEK 5/6 MC BEDRUCKT	K.11
1609840000	DEK 5/6,5 MC NEUTRAL	K.11
1609850000	DEK 5/6,5 MC BEDRUCKT	K.11
1609860000	WS 12/5 MC NEUTRAL	K.18
1609860000	WS 12/5 MC NEUTRAL	K.19
1609870000	WS 12/5 MC BEDRUCKT	K.14
1609880000	WS 15/5 MC NEUTRAL	K.14
1609890000	WS 15/5 MC BEDRUCKT	K.14
1609900000	WS 12/6 MC NEUTRAL	K.14
1609910000	WS 12/6 MC BEDRUCKT	K.15
1609920000	WS 12/6,5 MC NEUTRAL	K.15
1609930000	WS 12/6,5 MC BEDRUCKT	K.15
161000000		
1610000000	ZS 10/5 MC NEUTRAL	K.15
1610010000	ZS 10/5 MC BEDRUCKT	K.15
1610020000	ZS 12/6 MC NEUTRAL	K.15
1610030000	ZS 12/6 BEDRUCKT	K.15
1610110000	TSTW D 4.3	H.14
1611930000	ZGB 30	K.19
1615280000	AP MAK2.5	L.6
163000000		
1631350000	ESO 5 DIN A4 GELB BOG.	K.17
1631920000	ESO 5 S DIN A4-BOGEN	K.17
1631930000	SCHT 5 S	K.17
1631940000	STR 5 S F.SCHT 5 S	K.17
1633260000	AP VLI.1.5	L.6
1633320000	AP VLI.1.5/PE	L.6
1634780000	ESO 7 A4-BOGEN GELB	K.17
1634780000	ESO 7 A4-BOGEN GELB	K.19
1635000000	WS 10/5 MC NEUTRAL	K.16
1635000000	WS 10/5 MC NEUTRAL	K.19
1635010000	WS 10/5 MC BEDRUCKT	K.14
1636510000	ESO 15 BOGEN DIN A4	K.19
1636520000	STR 15 F. ZGB 15	K.19
1636530000	ZGB 15	K.19

Order No.	Type	Page
164000000		
1640740000	WS 8/5 MC NEUTRAL	K.14
1640750000	WS 8/5 MC BEDRUCKT	K.14
1646630000	ZS 15/5 MC NEUTRAL	K.15
1646640000	ZS 15/5 MC BEDRUCKT	K.15
165000000		
1653340001	DEK 8 FW 1-50 TAMPOPR.	K.9
1653340001	DEK 8 FW 51-100 TAMPOPR.	K.9
1653350001	DEK 8 FS 1-50 TAMPOPR.	K.9
1653350001	DEK 8 FS 51-100 TAMPOPR.	K.9
166000000		
1667700000	WAD 8 SONDERDRUCK	K.18
167000000		
1670360000	QVSK 2 SAKT1	L.20
1670370000	ESO 5 POLY.WEISS A4-BOG.	K.17
1670380000	ESO 5 POLY.GELB A4-BOG.	K.17
1670390000	ESO 7 POLY.WEISS A4-BOG.	K.19
1670390000	ESO 7 POLY.WEISS A4-BOG.	K.17
1670400000	ESO 7 POLY.GELB A4-BOG.	K.17
1670400000	ESO 7 POLY.GELB A4-BOG.	K.19
1678650000	FK 4	L.14
168000000		
1686920000	PRINT KIT	K.25
169000000		
1692261001	KLBU 3-8 SC	G.8
171000000		
1712311001	KLBU 4-13.5 SC	G.8
1712321001	KLBU 1	

Order No.	Type	Page
1762320001	DEK 5/3,5 MC FSZ 11-10	K.8
1762320011	DEK 5/3,5 MC FSZ 11-20	K.8
1762320021	DEK 5/3,5 MC FSZ 21-30	K.8
1762320031	DEK 5/3,5 MC FSZ 31-40	K.8
1762320041	DEK 5/3,5 MC FSZ 41-50	K.8
1762320051	DEK 5/3,5 MC FSZ 51-60	K.8
1762320061	DEK 5/3,5 MC FSZ 61-70	K.8
1762320071	DEK 5/3,5 MC FSZ 71-80	K.8
1762320081	DEK 5/3,5 MC FSZ 81-90	K.8
1762320091	DEK 5/3,5 MC FSZ 91-100	K.8
1762320101	DEK 5/3,5 MC FSZ 101-110	K.8
1762320111	DEK 5/3,5 MC FSZ 111-120	K.8
1762320121	DEK 5/3,5 MC FSZ 121-130	K.8
1762320131	DEK 5/3,5 MC FSZ 131-140	K.8
1762320141	DEK 5/3,5 MC FSZ 141-150	K.8
1762440000	ADAPTER ALU STI-S	K.25
1762440000	ADAPTER ALU STI-S	K.24
1767090000	SPEEDMARKING-LASER	K.21
1767730000	DEK 5/3,5 MC bedruckt	K.11
1768020000	BS 35II KLBUE2X3-8/2X2-6	G.10
1768090000	WS 14/5 MC NEUTRAL	K.14
1768540000	Plotterpen 0,25	K.25
1768540000	Plotterpen 0,25	K.24
1768550000	Plotterpen 0,35	K.25
1768550000	Plotterpen 0,35	K.24
1768560000	Plotterpen 0,5	K.25
1768560000	Plotterpen 0,5	K.24
1768570000	Plotterpen 0,18	K.25
1768570000	Plotterpen 0,18	K.24

1770000000

1770070000	TONER SMARK LASER	K.21
1770490000	DEK 5/7,5 MC SONDERDR.	K.11
1772120000	Tinte 2000 25ml	K.25
1772120000	Tinte 2000 25ml	K.24
1772130000	Reiniger 2000 25ml	K.24
1772130000	Reiniger 2000 25ml	K.25
1772810000	SAK 6/EN OR	I.7
1772820000	SAK 6/EN GE	I.7
1772830000	SAK 10/EN OR	I.7
1773330001	WS 12/5 FWZ 1-10	K.9
1773330011	WS 12/5 FWZ 11-20	K.9
1773330021	WS 12/5 FWZ 21-30	K.9
1773330031	WS 12/5 FWZ 31-40	K.9
1773330041	WS 12/5 FWZ 41-50	K.9
1773340000	SAK 4/EN WS	I.7
1773350000	SAK 6/EN WS	I.7
1773360000	WS 8/5 Sonderdr. Laser	K.9
1773370000	WS 10/5 Sonderdr. Laser	K.9
1773380000	WS 12/5 Sonderdr. Laser	K.9
1773410000	AP 100 GR	I.6
1773430001	WS 12/5 FSZ 1-10	K.9
1773430011	WS 12/5 FSZ 11-20	K.9
1773430021	WS 12/5 FSZ 21-30	K.9
1773430031	WS 12/5 FSZ 31-40	K.9
1773430041	WS 12/5 FSZ 41-50	K.9
1773521686	WS 8/5 MC neutral RT	K.14
1773521687	WS 8/5 MC neutral GE	K.14
1773521690	WS 8/5 MC neutral OR	K.14
1773521693	WS 8/5 MC neutral BL	K.14
1773531686	WS 10/5 MC neutral RT	K.14
1773531687	WS 10/5 MC neutral GE	K.14
1773531690	WS 10/5 MC neutral BL	K.14
1773541686	WS 12/5 MC neutral RT	K.14
1773541687	WS 12/5 MC neutral GE	K.14
1773541690	WS 12/5 MC neutral OR	K.14
1773541693	WS 12/5 MC neutral BL	K.14
1773551686	WS 12/6 MC neutral RT	K.14
1773551687	WS 12/6 MC neutral GE	K.14
1773551689	WS 12/6 MC neutral VI	K.14
1773551690	WS 12/6 MC neutral OR	K.14
1773551692	WS 12/6 MC neutral BR	K.14
1773551693	WS 12/6 MC neutral BL	K.14
1773561686	WS 12/6,5 MC neutral RT	K.15
1773561687	WS 12/6,5 MC neutral GE	K.15
1773561688	WS 12/6,5 MC neutral GN	K.15
1773561693	WS 12/6,5 MC neutral BL	K.15
1773571687	WS 15/5 MC neutral GE	K.14
1773900000	SAK 10/EN SW	I.7
1778270000	WS 12/3,5 MC neutral	K.14
1778280000	WS 12/3,5 MC Sonderdr.	K.14
1779100000	TSTW 5/M5 ZN	H.14

1780000000

1782880000	Magazin SMark Laser	K.21
1783550000	AP DL12,5 DB	I.6
1783800000	AP DL22,5/PE DB	I.6
1784150000	AP VL11,5 DB	I.6
1784160000	AP VL11,5/PE DB	I.6
1784210000	AP DL22,5 DB	I.6
1784390000	SAK 16/EN BL	I.7
1784390000	SAK 16/EN BL	C.3
1784400000	SAK 35/EN BL	C.4
1784400000	SAK 35/EN BL	I.7
1784410000	SAK 10/EN BL	C.3
1784410000	SAK 10/EN BL	I.7

Order No.	Type	Page
1790060000	WAD 5 Sonderdruck	K.18
1790080000	AP 110 GR	I.6
1792000000	WS 10/5 MC Midd. Neutr.	K.16
1792000000	WS 10/5 MC Midd. Neutr.	K.14
1792000000	WS 10/5 MC Midd. Neutr.	K.17
1792010000	WS 10/5 MC Midd. Sonder	K.14
1797460000	Tintenpatrone PrintJet	K.22
1799900000	SAK 2,5/35 SW	I.7
1799910000	SAK 2,5/35 RT	I.7
1799920000	SAK 2,5/35 DBL	I.7

1800000000

1802180000	MC-MOBIL AUFN. SF 4-6	K.25
1802890000	TS 27X12.5M/ST/FZN	G.11
1805480000	BZT 2 WS 10/5	K.16
1805490000	BZT 1 WS 10/5	K.16
1805520000	BZT 1 ZA WS 10/5	K.16
1805530000	BZT 2 ZA WS 10/5	K.16
1805880000	Snap Mark I	K.16
1805980000	TS 35X15/6X18 2M/ST/ZN	H.11
1806120000	EM 8/30	K.19
1806630000	IS 2 KG	J.20
1806650000	IS 3 KG	J.20
1806660000	IS 4 KG	J.20

1810000000

1814660000	ZF 4 S BL	H.7
1814670000	ZF 4 S GN	H.7
1814680000	ZF 4 S	H.7
1817780000	SAK 4 BL RS-SET	I.7
1817860000	SAK 2,5 BL RS-SET	I.7
1818400000	WS 10/6 MC Midd. Neutr.	K.14
1818410000	WS 10/6 MC Midd. Sonder	K.15

1820000000

1820200000	AP SAKR BE RS-SET	I.6
1821480000	SAK 2,5/35 GE	I.7
1828450000	WS 10/6 MC NEUTRAL	K.14
1828460000	WS 10/6 MC Sonderdruck	K.15

1830000000

1837380000	TS 35X15/LL/5 2M/ST/ZN	H.11
------------	------------------------	------

1840000000

1848290000	TS 35X15/2.3 2M/AL/BK	H.11
------------	-----------------------	------

1850000000

1853950000	SAK 4/EN GR 7042	I.7
1853960000	SAK 10/EN GR PAL 7042	I.7
1853970000	AP SAK4-10 GR 7042	I.6
1854090000	WS 10/15 MC Neutr.	K.15
1854100000	WS 10/15 MC Sonderdruck	K.15
1854490000	DEK 5/5 PLUS MC NEUTRAL	K.11
1854500000	DEK 5/5 PLUS MC SONDERDR.	K.11
1856740000	DEK 5/8 MC Neutral	K.11
1856750000	DEK 5/8 MC Sonderdruck	K.11
1858440000	SAK 2,5/EN SW	I.7
1858450000	SAK 2,5/EN BR	I.7
1858460000	SAK 2,5/EN WS	I.7
1858920000	Tintentank PrintJet II	K.22
1858950000	CleanUnit PrintJet II	K.22

1860000000

1866290000	TS 35X15/6X25 2M/ST/ZN	H.11
1866850000	SAK 6/35 GN/GE	I.7

1900000000

1905490000	M-PRINT PRO	K.26
1905490000	M-PRINT PRO	K.24
1905500000	M-PRINT PRO ADVANCED	K.26
1905950000	WS 10/8 MC NEUTRAL	K.15
1905970000	WS 10/12 MC NEUTRAL	K.15
1906000000	WS 12/8 MC NEUTRAL	K.15
1906010000	WS 12/8 MC SONDERDRUCK	K.15
1906030000	WS 10/8 MC SONDERDRUCK	K.15
1906060000	WS 10/12 MC SONDERDRUCK	K.15
1907020000	DK 4 Q/EN	C.5
1907030000	DK 4 Q/EN BL	C.4
1907040000	DK 4 Q/EN	C.4
1907520000	DEK 5/5 PLUS MC GE	K.11

1910000000

1917410000	WS 10/6 MC MIDDLE OR	K.14
1917420000	WS 10/6 MC MIDDLE GN	K.14
1917430000	WS 10/6 MC MIDDLE GE	K.14
1917440000	WS 10/6 MC MIDDLE RT	K.14

Order No.	Type	Page
1920640000	PLOTTER PEN 0.25 P-INK	K.25
1920640000	PLOTTER PEN 0.25 P-INK	K.24
1920650000	PLOTTER PEN 0.35 P-INK	K.24
1920650000	PLOTTER PEN 0.35 P-INK	K.25
1924310000	MCP AP SF4-6	K.24
1924320000	MCP KLEBESTREIFEN	K.24
1924330000	P-CLEANER	K.25
1924330000	P-CLEANER	K.24
1924340000	P-INK	K.24
1924340000	P-INK	K.25
1924350000	MCP COVER	K.24
1924360000	MCP AP	K.24
1924370000	MCP AP LABLES	K.24
1925000000	MCP PLUS	K.23
1927510000	WS 12/5 PLUS MC NEUTRAL	K.14
1927520000	WS 12/5 PLUS SONDERDRUCK	K.14
1927530000	WS 12/6 PLUS MC NEUTRAL	K.14
1927540000	WS 12/6 PLUS SONDERDRUCK	K.15

1920000000

1920640000	PLOTTER PEN 0.25 P-INK	K.25
1920640000	PLOTTER PEN 0.25 P-INK	K.24
1920650000	PLOTTER PEN 0.35 P-INK	K.24
1920650000	PLOTTER PEN 0.35 P-INK	K.25
1924310000	MCP AP SF4-6	K.24
1924320000	MCP KLEBESTREIFEN	K.24
1924330000	P-CLEANER	K.25
1924330000	P-CLEANER	K.24
1924340000	P-INK	K.24
1924340000	P-INK	K.25
1924350000	MCP COVER	K.24
1924360000	MCP AP	K.24
1924370000	MCP AP LABLES	K.24
1925000000	MCP PLUS	K.23
1927510000	WS 12/5 PLUS MC NEUTRAL	K.14
1927520000	WS 12/5 PLUS SONDERDRUCK	K.14
1927530000	WS 12/6 PLUS MC NEUTRAL	K.14
1927540000	WS 12/6 PLUS SONDERDRUCK	K.15

1930000000

1935130000	MCP EP	K.24
------------	--------	------

1950000000

1951870000	WS 8/5 PLUS MC NEUTRAL	K.14
1951880000	WS 8/6 PLUS MC NEUTRAL	K.14
1951920000	DEK 5/30 MC NEUTRAL	K.18
1951920000	DEK 5/30 MC NEUTRAL	K.11

2010000000

2012770000	AP STA2.5 0.5MM	I.6
2012790000	SK E14 SAKS4 USA	B.25
2012790000	SK E14 SAKS4 USA	A.27

2030000000

2038000000		F.6
2038000000		F.5

2070000000

2076890000	AP SAK4-10 GE	I.6
2076900000	AP SAK16 GE	I.6
2076910000	AP SAK35/TW SAK16 GE	I.6
2077060000	AP AST3+4/35 GE	I.6
2077070000	AP AKZ4 GE	I.6

2090000000

2093550000		I.6
------------	--	-----

2110000000

2119490000	AP 2 DSG1.5T	I.6
2144900000	AP SAK2.5/35	I.6

3710000000

3710000000		I.9
------------	--	-----

3720000000

3720000000		I.9
------------	--	-----

3830000000

3835020000	PPT/35	D.9
3835120000	AP PPT/35	I.6
3835120000	AP PPT/35	D.9

3890000000

3896100000	SP 15	G.9
3896200000	SP 20	G.9
3896300000	SP 30	G.9

4060000000

4062150000	PJ-Clean Unit	K.22
------------	---------------	------

4140000000

4140450000	AP SAKB/C/T BE	I.6
4145220000	AP RV	I.6

4170000000

4173520000	AP SAKB/C/T1 DB	I.6
------------	-----------------	-----

6250000000

6253140000	SAK 2,5 AL BLUE (E)	I.
------------	---------------------	----

Table with columns: Order No., Type, Page. Contains a list of items from 9004370000 to 9008860000.

Table with columns: Order No., Type, Page. Contains a list of items from 9008880000 to 9019170000. Includes a large section header '9010000000'.

Table with columns: Order No., Type, Page. Contains a list of items from 9019180000 to 9028820000. Includes a large section header '9020000000'.

Table with columns: Order No., Type, Page. Contains a list of items from 9028290000 to 9054080000. Includes large section headers '9030000000' and '9050000000'.

Table with columns: Order No., Type, Page. Contains a list of items from 9036200000 to 9037200000.

Table with columns: Order No., Type, Page. Contains a list of items from 9037200000 to 9038200000.

Table with columns: Order No., Type, Page. Contains a list of items from 9038200000 to 9039200000.

Table with columns: Order No., Type, Page. Contains a list of items from 9039200000 to 9040200000.

Table with columns: Order No., Type, Page. Contains a list of items from 9040200000 to 9041200000.

Table with columns: Order No., Type, Page. Contains a list of items from 9041200000 to 9042200000.

Table with columns: Order No., Type, Page. Contains a list of items from 9042200000 to 9043200000. Includes a large section header '9120000000'.

Order No.	Type	Page	Order No.	Type	Page
9130000000			9540000000		
9130980000	SAK 4/EN SW	I.7	9540000000	ZEW 35	H.13
9130990000	SAK 4/EN BR	I.7			
9150000000			9910000000		
9154850000	AP OSC 10/16	I.6	9918370000	DMS MANUELL 0,5-1,7	J.18
9154860000	AP OSC 4	I.6	9918380000	DMS MANUELL 2,0-8,0	J.18
9200000000			9918390000	DMSI MANUELL 0,5-1,7	J.19
9201940000	SDI T8	J.14	9918400000	DMSI MANUELL 2,0-8,0	J.19
9202820000	H0,75/19S ZH W	J.28	9918410000	WK SI 0,4x2,5	J.19
9202830000	H0,75/19DS ZH GR	J.29	9918420000	WK SI 0,5x3,0	J.19
9202840000	H0,75/19TS ZH HBL	J.30	9918430000	WK SI 0,6x3,5	J.19
9202870000	H 1,5/24 XS SW	J.31	9918440000	WK SI 0,8x4,0	J.19
9202880000	H 2,5/24 XS BL	J.31	9918450000	WK SI 1,0x5,5	J.19
9202900000	H 0,5/16 S OR	J.32	9918460000	WK IK PH0	J.19
9202910000	H0,5/16 DS Weiß	J.32	9918470000	WK IK PH1	J.19
9205690000	SDI 0.4X2.0X60	J.14	9918480000	WK IK PH2	J.19
9205700000	SDI 1.0X4.5X175	J.14	9918490000	WK IK PZ0	J.19
9205710000	SDI 1.0X5.5X175	J.14	9918500000	WK IK PZ1	J.19
9420000000			9918510000	WK IK PZ2	J.19
9426770000	H2,5/14TS GR	J.32	9918520000	WK S 0,4x2,5	J.18
9450000000			9918530000	WK S 0,5x3,0	J.18
9451000000	H35,0/30S	J.33	9918540000	WK S 0,6x3,5	J.18
9500000000			9918550000	WK S 0,8x4,0	J.18
9501160000	RSF 3/35	A.11	9918560000	WK S 1,0x5,5	J.18
9501310000	KST 6	B.54	9918570000	WK K PH0	J.18
9501320000	KST 8	B.55	9918580000	WK K PH1	J.18
9501330000	KST 10	B.55	9918590000	WK K PH2	J.18
9501340000	KST 12	B.55	9918600000	WK K PZ0	J.18
9501350000	QL 2 KST6	B.54	9918610000	WK K PZ1	J.18
9501350000	QL 2 KST6	A.48	9918620000	WK K PZ2	J.18
9501360000	QL 2 KST8	B.55			
9501360000	QL 2 KST8	A.49			
9501370000	QL 2 KST10	B.55			
9501370000	QL 2 KST10	A.49			
9501380000	QL 2 KST12	A.49			
9501380000	QL 2 KST12	B.55			
9502540000	QL 2 SAKK 4	D.2			
9502550000	QL 3 SAKK 4	D.2			
9502560000	QL 4 SAKK 4	D.2			
9502570000	QL 10 SAKK 4	D.2			
9502580000	VH 13.5 SAKK 4	D.2			
9502600000	SAKK 4	D.2			
9502610000	SAKK 10	D.3			
9502630000	AP SAKK4/10 KER/WS	I.6			
9502630000	AP SAKK4/10 KER/WS	D.3			
9502630000	AP SAKK4/10 KER/WS	D.2			
9502650000	QL 2 SAKK 10	D.3			
9502660000	QL 3 SAKK 10	D.3			
9502670000	QL 4 SAKK 10	D.3			
9502680000	QL 10 SAKK 10	D.3			
9502690000	VH 12.5 SAKK10	D.3			
9503300000	KDKS 1/32	B.21			
9503310000	KDKS 1/35	A.23			
9503330000	AP KDKS1 1.5	I.6			
9503340000	AP KDKS1 EN	I.6			
9503340000	AP KDKS1 EN	C.7			
9503370000	KST 5	B.54			
9506940000	KST 6/35 M6X22	A.48			
9506950000	KST 8/35 M8X30	A.49			
9506960000	KST 10/35 M10X39	A.49			
9506970000	KST 12/35 M12X37	A.49			
9509420000	QL 2 SAKK 4 TIN	D.2			
9509430000	QL 3 SAKK 4 TIN	D.2			
9509440000	QL 4 SAKK 4 TIN	D.2			
9509450000	QL 10 SAKK 4 TIN	D.2			
9509460000	VH 13.5 SAKK4	D.2			
9509470000	QL 2 SAKK 10 TIN	D.3			
9509480000	QL 3 SAKK 10 TIN	D.3			
9509490000	QL 4 SAKK 10 TIN	D.3			
9509500000	QL 10 SAKK 10 TIN	D.3			
9509510000	VH 12.5 SAKK10	D.3			
9509570000	KSKM 1/32 G20	B.20			
9509580000	KSKM 2/32 GZ 1X1/4	B.20			
9509600000	KSKM 1/35 G20	A.22			
9509610000	KSKM 2/35 GZ 1X1/4	A.22			
9509620000	KSKM 3/35 GZ 1 1/4X1/4	A.23			
9509630000	AP KSKM	I.6			
9520000000			9530000000		
9528300000	KST 5/35 M5X18	A.48			
9528320000	KST 8/35 M8X30	A.49			
9528330000	KST 10/35 M10X39	A.49			
9528340000	KST 12/35 M12X37	A.49			
9530000000					
9532470000	AP KDKS1 1.5 DB	I.6			

Addresses worldwide

- AE United Arab Emirates**
Weidmüller Middle East FZE
P.O. Box # 8591
SAIF-Zone
Sharjah – VAE
Phone +971 6 5572723
Fax +971 6 5672724
wme.info@weidmueller.com
- AR Argentina**
CPI SA
Bauness 2660
1431 Buenos Aires
Phone +54 11 45238008
compras@cpi.com.ar
- AT Austria**
Weidmüller Ges.m.b.H.
Industriezentrum Nö Süd
Straße 2, Objekt M2
2355 Wiener Neudorf
Phone +43 2236 6708-0
Fax +43 2236 6708-199
office.at@weidmueller.com
- AU Australia**
Weidmüller Pty. Ltd.
43 Huntingwood Drive
Huntingwood,
NSW, 2148
P.O.Box 6944
Blacktown
NSW, 2148
Phone +61 2 9671-9999
Fax +61 2 9671-9911
info@weidmuller.com.au
www.weidmuller.com.au
- AZ Azerbaijan**
West Industries Ltd.
Caspian Plaza, 5-th Floor
44 J. Jabbarly Str., Baku
Phone +99412 499 15 15
Fax +99412 499 14 93
sales@west-1.com
- BA Bosnia and Herzegovina**
BH ES Elektrosistem d.o.o.
ul. J. Veselinovica 18
78000 Banja Luka
Phone +387 51 317500
Fax +387 51 317500
elsist@inecco.net
www.elektrosistem.co.yu
- BE Belgium**
Weidmüller Benelux B.V.
Mechelsesteenweg 519 bus 6 en 7
1930 Nossegem
Phone +32 (0)2 752 40 70
Fax +32 (0)2 751 36 06
info@weidmueller.be
- BG Bulgaria**
Weid-Bul EOOD
1113 Sofia
33 A 'Nezabravka' Str.
bl. 315/3/10
Phone +359 2 9632560
weidbul@nat.bg
www.weidbul.com
- BH Bahrain**
Khayber Trading Company
P.O. Box 1976 Manama,
Phone +973 17720747
Fax +973 17720331
khayber@batelco.com.bh
- BR Brazil**
Conexel Conexoes Elétricas Ltda.
Rua Garcia Lorca, 176- V. Paulicéia,
09695-900, Sao Bernardo do
Campo - SP
Phone +55 11 43669600
Fax +55 11 43621677
venddas@conexel.com.br
www.conexel.com.br
- BY Belarus**
Technikon Ltd.
Oktyabrskaya Str. 16/5
Apt. 704, 220030, Minsk
Phone +375 17 2104626
Fax +375 17 2275830
weidmueller@technikon.by
- CA Canada**
W Interconnections Canada Inc.
10 Spy Court, Markham,
Ontario L3 R5 H6
Phone +1 905 475-1507
Fax +1 905 475-5855
info1@weidmuller.ca
www.weidmuller.ca
- CH Switzerland**
Weidmüller Schweiz AG
Rundbuckstrasse 2
8212 Neuhausen am Rheinfall
Phone +41 52 6740707
Fax +41 52 6740708
info@weidmueller.ch
www.weidmueller.ch
- CL Chile**
Felipe Bahamondes S.A./ATS AGRO
Servicios Agroindustriales
Maria Luisa Santander 0475
Providencia
Casilla 3425
Santiago
Phone +56 2 341-1271
Fax +56 2 341-1275
felipe@atsintech.com
- CN China**
Weidmüller Interface International
Trading (Shanghai) Co., Ltd.
12 F, Century Ba-Shi Building,
No. 398 Huaihai Road (N)
Shanghai 200020
P.R. China
Phone +86 21 63868188
Fax +86 21 63867177
www.cnweidmuller.com
- CO Colombia**
Automatizacion Avanzada S. A.
Cr 97 # 24C-23 Bodega 4 Bogotá
Phone +57 1 5478510
Fax +57 1 4132285
productos@
automatizacionavanzada.com
- CR Costa Rica**
ELVATRON S.A.
400 Norte
Banco Costa Rica, la Uruca,
San José
Phone +506 2 961060
Fax +506 2 960328
dirk.haase@elvatron.com
- CS Serbia**
ES-YU Elektrosistem
Pariske komune 41
11070 Novi Beograd
Phone +381 11 697212
Fax +381 11 693608
esyu@eunet.yu
www.elektrosistem.co.yu
- CZ Czech**
Weidmüller s. r. o.
Videnska ul. 340
25242 Vestec u Prahy
Phone +420 2 44001400
Fax +420 2 44001499
office@weidmueller.cz
- DE Germany**
Weidmüller GmbH & Co. KG
Ohmstraße 9
32758 Detmold
Phone +49 5231 1428-0
Fax +49 5231 1428-116
weidmueller@weidmueller.de
www.weidmueller.de
- DK Denmark**
Knud Wexøe A/S
Skaettekaeret 11
P.O. Box 152
2840 Holte
Phone +45 45465800
Fax +45 45465801
wexoe@wexoe.dk
- EC Ecuador**
Elsystec S.A.
Vasco de Contreras N35-261
y Mañosa
Phone +593 2 2455698
Fax +593 2 2245241
info1@elsystec.com.ec
elsystec@elsystec.com.ec
- EE Estonia**
Alter Electric OÜ
Gaasi 4a
11415 Tallinn
Phone +372 6519666
Fax +372 6519667
alter@alter.ee
www.alter.ee
- EG Egypt**
Standard Electric
87, Mohamed Farid Street
Heliopolis, Cairo
Phone +20 6 42 29 77/ 6 42 29 88
Fax +20 6 42 29 55
stdelec@rite.com
- ES Spain**
Weidmüller S. A.
Narcis Monturiol 11-13
Pol.Ind. Sudoeste
08960 Sant Just Desvern
Barcelona
Phone +34 93 4803386
Fax +34 93 3718055
weidmuller@weidmuller.es
www.weidmuller.es
- FI Finland**
JUHA-ELEKTRO OY
Kylvöpolku 6, P. O. Box 57
00681 Helsinki
Phone +358 10 8328 100
Fax +358 10 8328 169
- FR France**
Weidmüller EURL
12, Chaussée Jules César
B.P. 263 Osny
95523 CERGY PONTOISE Cedex
Phone +33 1 34245500
Fax +33 1 34245501
mail@weidmuller.fr
www.weidmuller.fr
- GB Great Britain**
Weidmüller Ltd.
1 Abbey Wood Road
Kings Hill, West Malling
Kent ME19 4YT
Phone +44 845 094 2006
Fax +44 1732 874295
sales@weidmuller.co.uk
www.weidmuller.co.uk
- GR Greece**
Electrorama S.A.
Phone +30 2410 552533
Fax +30 2410 283463
weidmuller@electrorama.com.gr
- HK Hong Kong**
United Equity Limited
Suite B, 11/F International Industrial
Centre
2-8 Kwei Tei Street, Fotan, Shatin
Phone +852 26876739
Fax +852 26876735
united_equity@sinatown.com
- HR Croatia**
Elektro Partner d.o.o.
Radnicka cesta 22
10000 Zagreb
Phone +385 1 6184793
Fax +385 1 6184795
elektropartner@zg.htnet.hr
- HU Hungary**
Weidmüller Kereskedelmi Kft
Mádi u. 50
1104 Budapest
P. O. Box 22
1507 Budapest
Phone +36 1 464-7888
Fax +36 1 3827701
info@weidmueller.hu
- ID Indonesia**
PT. NEGO ELECTRINDO
Ruko Mega Grosir Cempaka Mas,
Blok 1 No 20 – 22
Jl. Let.Jend. Suprato –
JAKARTA 10640
Phone +62 21 42882255
Fax +62 21 42882266
sales@negoelectrindo.co.id
- IE Ireland**
A.P. Haslam Ltd.
14 Sunshine Ind. Estate
Crumlin Road
Dublin 12
Phone +353 1 453-2522
Fax +353 1 453-2949
paul.haslam@aphaslam.ie
- IL Israel**
A.U.Shay Ltd.
23 Imber St. Petach-Tikva
Phone +972 3 9233601
Fax +972 3 9234601
shay@uriel-shay.com
www.uriel-shay.com
- IL Israel**
ATEKA Ltd.
23 Hayetzira St.
Kiryat Aryeh
49130 Petach-Tikva, Israel
Phone +972 3 9392344
Fax +972 3 9243273
marketing@ateka.co.il
www.ateka.co.il
- IN India**
Weidmüller
Representative office
Vijay Dattani
Mobile +91 98440 97366
vcdattani@eth.net
- IR Iran**
TAF Co.
72, Iranshahr Av.
Unit 5,
15816 Teheran
Phone +98 21 8831-7851
Fax +98 21 8882-0268
info@taf-co.com
- IS Iceland**
Samey Automation Center
Lyngas 13, 210 Garoabaer,
Phone +354 510 5200
Fax +354 510 5201
samey@samey.is
- IT Italy**
Weidmüller S.r.l.
Via Albert Einstein 4
20092 Cinisello Balsamo
Milano
Phone +39 02 660681
Fax +39 02 6124945
weidmuller@weidmuller.it
www.weidmuller.it
- JO Jordan**
Trans Jordan for Electro
Mechanic Supplies PLC.
P.O.Box: 330607
Amman 11133
Phone +962 6 533 2020
Fax +962 6 533 5800
transjordan@batelco.jo
- JP Japan**
Nihon Weidmüller Co. Ltd.
Asahi Seimei Bldg. 11F
1-14-1 Fuchicho Fuchu-shi
Tokyo 183-0055
Phone +81 42 330-7891
Fax +81 42 330-7895
www.weidmuller.co.jp
- KR Korea**
Weidmüller Co., Ltd.
6th floor, Seahwa building, 242-54
Nonhyun-dong, Kangnam-Gu
Seoul
Zip: 135-830
Phone +82 2 5160003
Fax +82 2 5160090
info@weidmuller.co.kr

- KW Kuwait**
KANA CONTROLS General Trading & Cont. CO. W.L.L.
A1 Rai Industrial Area,
Plot 28-30, St. 31
P.O.Box: 25593
Safat, 13116 Kuwait
Phone +965-474 1373/4
Fax +965-474 1537
info@kanacontrols.com
- KZ Kazakhstan**
Please contact our Weidmüller branch office in Moscow, Russia
- LB Lebanon**
PROGRESS ENGINEERING
Beirut
Phone +961 1 444664
Fax +961 1 561880
progress@inco.com.lb
- LT Lithuania**
ELEKTROS IRANGA
Tinklu g.29a, 5319 Panevezys,
Phone +370 45582828
Fax +370 45582727
info@eliranga.lt
- LU Luxembourg**
Weidmüller Benelux B.V.
Phone +352 24 527145
Fax +352 24 527147
info@weidmuller.lu
- LV Latvia**
PROFS Latvija SIA
K. Ulmana gatve 104
LV-1029 Rīga
Phone +371 7870557
Fax +371 7870541
edgars.vilkins@profs.lv
www.profs.lv
- MD Moldova**
BERHORD A&D srl
Off 414, b-dul Decebal, 3,
Chisinau, RM
Phone +373 22 507137
Fax +373 22 507134
atiuleanu@berhord.com
- MK Macedonia**
ELEKTRO – SMK dooel
UL. III Makedonska brigada b.b.
1000 Skopje
Phone +389 22 460 295
Fax +389 22 460 298
Elektro-smk@telekabel.net.mk
- MT Malta**
Electrical Supplies & Services Ltd
104 J. Soberras Str.
Hamrun HMR 08
Phone +356 21 255 777
Fax +356 21 255 999
robert@ess.com.mt
- MX Mexico**
W Interconnections, S.A. de C.V.
Blvd. Hermanos Serdán No. 698
Col. San Rafael Oriente
Puebla, Pue. C.P. 72029
Phone +52 222 2686266 to 68 ext.101
Fax +52 222 2686219
clientes@weidmuller.com.mx
www.weidmuller.com.mx
- MY Malaysia**
Connect Plus Technology Sdn Bhd
No. 43, Jalan PJS 11/22,
Bandar Sunway, 46150 Petaling Jaya
Selangor Darul Ehsan
Phone +60 3 5633 7363
Fax +60 3-5633 6562
paul@cptech.com.my
www.cptech.com.my
- NL Netherlands**
Weidmüller Benelux B.V.
Franciscusweg 221
1216 SE Hilversum
Postbus 1505
1200 BM Hilversum
Phone +31 35 6261261
Fax +31 35 6234569
info@weidmuller.nl
www.weidmuller.nl
- NO Norway**
Siv. Ing. J. F. Knudtzen A/S
Billingstadsletta 97
1396 Billingstad, P.O. Box 160
1378 Nesbru
Phone +47 66 983350
Fax +47 66 980955
patorgersbraaten@jfknudtzen.no
- NZ New Zealand**
Cuthbert S. Steward Limited
27 Te Puni Street
POB 38496 Petone
Petone, Wellington
Phone +64 4 5686156
Fax +64 4 5686056
- OM Oman**
DAN INTERNATIONAL LLC.
PO.BOX 2901
111 Seeb
Phone +968 503 677
Fax +968 503 755
yedu@danintl.com
- PE Peru**
TECSOL S.A.C.
Huandoy N° : 501, Lima 32
Phone / Fax +51 1 562-0004
info@tecsol-peru.com
- PH Philippines**
Enclosure Systems Specialists Inc
NW-15 La Fuerza Compound
2241 Don Chino Roces Avenue
Makati City 1231 Philippines
Phone +63 2 813 8580
sales_encsys@pltdtdsl.net
- PK Pakistan**
Kana Controls (Pak)
Apartment No. 33 C III
Chenab Block,
Allama Iqbal Town
Lahore
Phone +92 42 5419948
+92 42 7845160
Fax +92 42 5422895
nadeem@kanapak.com
www.kanapak.com
- PL Poland**
Weidmüller Sp. z o.o.
ul. Golezdzinowska 10
03-302 Warszawa, Poland
Phone +48 22 5100940
Fax +48 22 5100941
biuro@weidmuller.com.pl
www.weidmuller.pl
- PT Portugal**
Weidmüller - Sistemas de Interface, S. A.
Estrada Outeiro Polima, Lote B,
N° B2, Escritório 2 - Abóboda
2785-518 Sao Domingos de Rana
Lisboa
Phone +351 21 4459190
Fax +351 21 4455871
weidmuller@weidmuller.pt
www.weidmuller.pt
- QA Qatar**
Doha Motors (Technical Division)
Post Box No. 145
Al Wakrath Road
Doha
Phone +974 465 1441
Fax +974 465 4579
dmtctech@qatar.net.qa
- RO Romania**
Rominterface Impex SRL
Phone +40 21 3220230
office@rominterface.ro
- RU Russia**
Weidmüller Representative Office
Shabolovka street 2
119049 Moscow, Russia
Phone +7 095 771-6940
Fax +7 095 771-6941
info@weidmueller.ru
www.weidmueller.ru
- SA Saudi Arabia**
Al Abdulkarim Holding Co.
P.O. Box. 4
Dammam 31411
Phone +9668337110 Ext.168
salehsk@akh.com.sa
- SESCO P.O. Box 3298
Al Khobar 31952
Phone +966 3 882 9546
Fax +966 3 882 9547
Customer.Service@sesco-gex.com
www.sesco-gex.com
- SE Sweden**
Weidmüller AB
Axel Danielssons väg 271
P.O. box 31025
200 49 Malmö
Phone +46 (0) 7 71 43 00 44
Fax +46 (0) 40 37 48 60
www.weidmuller.se
info@weidmuller.se
- SG Singapore**
Weidmüller Pte Ltd
70 Bendemeer Road
#04-03 Luzerne
Singapore 339940
Phone +65 6841 5311
Fax +65 6841 5377
info@weidmuller.com.sg
www.weidmuller.com.sg
- SI Slovenia**
Elektrospoji d.o.o.
Stegne 27, 1000 Ljubljana
Phone +386 15113810
Fax +386 15111604
elektrospoji@siol.net
www.elektrospoji.si
- SK Slovakia**
Elektris s.r.o.
Racianska 188
SK 831 53 Bratislava
Phone +421 2 4920 0111
bratislava@elektris.sk
- TH Thailand**
Pisanu Engineering Co., Ltd
800/2 Asoke Dindaeng Road,
Dindaeng, Bangkok 10400
Phone +66 2 245 9113
Fax +66 2 2463214
pisanu@kanit.co.th
www.pisanu.co.th
- TN Tunisia**
FAZE Services
Rue du Lac Turkana –
Immeuble Nour El Bouhaira
1053 Les Berges du Lac – Tunis
Tunisia
Phone +216 71 964-266
Fax +216 71 964-265
contact.fazeservices@faze.com.tn
www.groupefaze.com
- TR Turkey**
Weidmüller Elektronik Ticaret Ltd.Şti.
Kavacık Mah. Mh.İrabad Cad. 143/1
34810 Beykoz – Istanbul / Turkey
Phone +90 216 5371070 (Pbx)
Fax +90 216 5371077
info@weidmuller.com.tr
- TW Taiwan**
Fittatek Co., Ltd.
12F No. 185 Fu-Kuo Road,
Tso Ying Dist
Kaohsiung
Phone +886 7 556 0858
Fax +886 7 556 3279
stanley@fittatek.com.tw
- TW Taiwan**
Eucan Enterprise Ltd.
No. 145 He Ping 2nd Rd
Kaohsiung
Phone +886 7 715 6610
Fax +886 7 715 8748
mark@eucan.com.tw
www.eucan.com.tw
- UA Ukraine**
TEKO INTERFACE ooo
ul. Lewanewskogo 6
03058 Kiev
Phone +38 044 401 09 90/91/92
Fax +38 044 401 08 64
weidmueller@tekointerface.com
www.tekointerface.com.ua
- US United States**
W-Interconnections, Inc.
821 Southlake Boulevard,
Richmond, VA 23236
Phone +1 804 7942877
Fax +1 804 3792593
info@weidmuller.com
www.weidmuller.com
- UY Uruguay**
Rewo Uruguay S.A
Av. Bolivia 2001 esq Rocafuerte
Phone / Fax +598 260 48522
rewo@rewo Uruguay.com.uy
www.rewo Uruguay.com.uy
- UZ Uzbekistan**
OOO "Elektro Potential"
Gani Mavijanova str., 2B
100084 Tashkent
Phone +998 98-3003821
Fax +998 71-1249286
mz1958@yandex.ru
- VE Venezuela**
Somercinca C.A.
3era transversal de Los Dos caminos,
Ota Corazon de Jesús. 4ta de
Montecristo. Caracas
Phone +58 212 2352748
Fax +58 212 2399341
kiocmoeller@cantv.net
- VN Viet Nam**
AUMI Co., Ltd
E1, La Thanh Hotel,
218 Doi Can Street,
Lieu Giai Ward, Ba Dinh District,
Hanoi City, S.R.
Phone +84 4762 8601
Fax +84 4266 1391
aumi@aumi.com.vn
- Linh Kim Hai Co., Ltd
78 Hoa Cuc Street Ward 7,
Phu Thuan District,
Ho Chi Minh City
Phone +84 8517 1717
Fax +84 8517 1818
lkh@linhkimhai.com.vn
- New Sky Co.,
Ltd44/28 Tan Hai Street,
Ward 13, Tan Binh District,
Ho Chi Minh City
Phone +84 8812 6593
Fax +84 8812 6594
newsky-e@hcm.vnn.vn
www.newsky-e.com
- ZA South Africa**
Phambili Interface (Pty) Ltd
Phone +27 11 452 1930
Fax +27 11 452 6455
sales@weidmuller.co.za
www.weidmuller.co.za
- DE Other countries**
Weidmüller Interface GmbH & Co. KG
Postfach 3030
32720 Detmold
Klingenbergstraße 16
32758 Detmold
Phone +49 5231 14-0
Fax +49 5231 14-20 83
info@weidmueller.com
www.weidmueller.com

We cannot guarantee that there are no mistakes in the publications or software provided by us to the customer for the purpose of making orders. We try our best to quickly correct errors in our printed media. For this purpose we list corrections, which have been identified after publishing printed media, on our web site at www.weidmueller.com. For convenience we list these corrections against product catalogue number and/or page number. This Internet-database is part of our catalogue.

All orders are based on our general terms of delivery, which can be reviewed on the websites of our group companies where you place your order. On demand we can also send the general terms of delivery to you.

www.weidmueller.com

Argentina	Indonesia	Saudi Arabia
Australia	Iran	Serbia
Austria	Ireland	Singapore
Azerbaijan	Israel	Slovakia
Bahrain	Italy	Slovenia
Belarus	Japan	South Africa
Belgium	Jordan	Spain
Bosnia and Herzegovina	Kazakhstan	Sweden
Brazil	Korea	Switzerland
Bulgaria	Kuwait	Taiwan
Canada	Latvia	Thailand
Chile	Lebanon	Tunisia
China	Lithuania	Turkey
Colombia	Luxembourg	Ukraine
Costa Rica	Macedonia	United Arab Emirates
Croatia	Malaysia	United States
Czech	Malta	Uruguay
Denmark	Mexico	Uzbekistan
Ecuador	Moldova	Venezuela
Egypt	Netherlands	Viet Nam
Estonia	New Zealand	
Finland	Norway	
France	Oman	
Germany	Pakistan	
Great Britain	Peru	
Greece	Philippines	
Hong Kong	Poland	
Hungary	Portugal	
Iceland	Qatar	
India	Romania	
	Russia	

Weidmüller is the leading provider of solutions for electrical connectivity, transmission, conditioning and processing of power, signals and data in industrial environments. The company develops, produces and sells products in the field of electrical connectivity, functional electronics and communication electronics. Weidmüller's product and service portfolio is dedicated to add value to the products and thereby the business of our customers. The Weidmüller Group has a global focus with its own manufacturing plants, sales companies and representatives in over 70 countries.

Order number:
5664500000/10/2008/SMMD

