



PLUTO Ethernet Gateway

User Manual

GATE-EIP

GATE-EC

GATE-S3

GATE-PN

GATE-MT

EtherNet/IP™

EtherCAT®

Sercos III

PROFINET®

Modbus TCP

Reference:

[REF x]	Text
REF 1	Pluto Operating instructions, Hardware 2TLC172001Mxxyy_z Pluto Programming manual 2TLC172002Mxxyy_z Pluto Gateway Manual 2TLC172009Mxxyy_z

Trademark Notices:

EtherNet/IP is a registered trademark by ODVA.
For more information see www.odva.com.

EtherCAT is a registered trademark and patented technology,
licensed by Beckhoff Automation GmbH, Germany.
For more information see www.ethercat.org.

Sercos is a registered trademark by Sercos International and Sercos North America.
For more information see www.sercos.com.

PROFINET is a trademark by PROFIBUS and PROFINET International (PI)
For more information see www.profibus.com.

Modbus TCP is according to the Modbus Organization.
For more information see www.modbus.org.

Table of contents:

1	Version information	8
2	Cyber security disclaimer	9
3	Cyber security deployment guideline	10
3.1	Network installation	10
3.2	Limit network connections	10
3.3	Pluto remote handling	12
3.4	PC port usage (only local access)	12
4	General	13
4.1	Installation	13
4.1.1	Mounting	13
4.1.2	Electrical installation	14
4.2	Maintenance and service	15
4.3	GATE-E2 replacement	15
5	Hardware	16
5.1	Connection, indication and switches	16
5.1.1	Top side	16
5.1.1.1	ABB StatusBus terminal	17
5.1.1.2	Pluto bus terminal	17
5.1.1.3	Configuration switch	18
5.1.2	Front panel	18
5.1.2.1	“K” button	18
5.1.2.2	PC port	18
5.1.2.3	Indicators (LED)	19
5.1.2.3.1	Gateway status	19
5.1.2.3.2	Ethernet protocol status	20
5.1.2.3.3	Ethernet link status	20
5.1.3	Bottom side	20
5.1.3.1	Ethernet port 1	21
5.1.3.2	Ethernet port 2	21
5.1.3.3	Power terminal	21
6	Common configuration	22
6.1	Pluto bus	22
6.1.1	Connection	22
6.1.2	Baud rate detection	22
6.1.3	Status indication	22
6.1.4	Gateway node number	22
6.1.4.1	Set by PLC	22
6.1.4.2	Set by DIP switch	23
6.1.4.3	Set by terminal command	23
6.2	IP address assignment	23
6.3	Network services	24
6.3.1	ICMP Ping command	24
6.3.2	Industry Ethernet Protocol	24
6.3.3	Remote server	24
6.4	Verification of configuration	25
6.5	Terminal commands	26
6.5.1	bg – gateway network status	26
6.5.2	bs – Pluto bus status	26
6.5.3	bc – gateway configuration status	27
6.5.4	bw – industry Ethernet protocol status	28
6.5.5	v – version information	28
6.5.6	h – help	29
6.5.7	exit – exit	30
6.5.8	View Pluto data	30
6.5.9	View gateway data	30

6.5.10	pl/pkl – Download Pluto project.....	31
6.6	Terminal commands (only PC port).....	31
6.6.1	time – get run time	31
6.6.2	cn – change gateway node number	31
6.6.3	addc – clear additional data configuration	31
6.6.4	adds – configure additional data	32
6.6.5	ctp – configure “Data to Pluto”.....	32
6.6.6	ipaddr – change IP address	33
6.6.7	remote – enable/disable remote operation of Pluto system	33
6.6.8	name – change the device station name (GATE-PN).....	34
6.6.9	reset – restart the unit.....	34
6.6.10	sys – firmware update of the unit	34
6.6.11	def – restore factory settings.....	35
6.6.12	dout – disconnect remote clients.....	35
6.6.13	test – test command.....	35
6.7	Silent commands	35
6.8	Firmware update.....	36
6.8.1	Firmware update via PC port using Pluto Manager	36
6.8.2	Firmware update via PC port.....	38
7	GATE-EIP, EtherNet/IP.....	40
7.1	Ethernet Connection	40
7.2	IP address configuration	40
7.3	Status indication.....	40
7.3.1	Module Status.....	41
7.3.2	Network Status	41
7.4	Service port information	42
7.5	Rockwell integration.....	43
8	GATE-EC, EtherCAT	48
8.1	Ethernet Connection	48
8.2	IP address configuration	48
8.3	Status indication.....	48
8.3.1	Link/Activity.....	48
8.3.2	RUN Status.....	49
8.3.3	Error Status.....	49
8.3.4	LED handling	50
8.4	ABB AC500 integration	51
8.4.1	Device repository and XML file.....	51
8.4.2	Hardware	52
8.4.3	CM_579 Master	52
8.4.4	Gate_EC_Pluto_Gateway	53
8.4.5	Startup parameters	54
8.4.6	I/O mapping list.....	56
8.5	Beckhoff TwinCAT integration.....	57
8.5.1	Add device description file	57
8.5.2	Scan system for the device	57
8.5.3	Firmware update.....	57
9	GATE-S3, Sercos III	60
9.1	Ethernet Connection	60
9.2	IP address configuration	60
9.3	Status indication.....	61
9.4	Service port information	61
9.5	Bosch-Rexroth IndraWorks integration.....	62
9.5.1	Add device description file	62
9.5.2	Scan system for the device	63
9.5.3	Gateway configuration	64
10	GATE-PN, PROFINET	65
10.1	Description file	65

10.2	Data format	65
10.3	Ethernet Connection	65
10.4	IP address configuration	66
10.5	Status indication.....	67
10.5.1	SF (System Failure).....	67
10.5.2	BF (Bus Failure).....	67
10.6	Service port information	67
10.7	ABB AC500 implementation.....	68
10.7.1	Device repository and XML file.....	68
10.7.2	Hardware	69
10.7.2.1	Adding objects	69
10.7.2.2	Configuring objects	70
10.7.2.3	Configuring Gate-PN.....	70
10.7.3	PROFINET name.....	71
10.7.4	Assigning variable names	72
10.8	Siemens integration	73
10.8.1	Install GSD XML file.....	73
10.8.2	Add the device to the PROFINET network	74
10.8.2.1	PROFINET name and IP address	74
10.8.2.2	IO Cycle.....	75
10.8.2.3	Module parameters of the Head module	75
10.8.2.4	Device view.....	76
10.8.2.4.1	Adding modules under the Head module	76
10.8.2.4.2	Module parameters of modules under the Head module	77
10.8.2.4.3	Addressing of in- and out-data	78
10.8.2.5	Tag list.....	79
10.8.2.5.1	Example of Pluto A20 family mapping.....	80
11	GATE-MT, Modbus TCP	81
11.1	Ethernet Connection	81
11.2	IP address configuration	81
11.3	Status indication.....	81
11.3.1	RUN.....	82
11.3.2	ERR.....	82
11.4	Service port information	82
11.5	Integration and configuration.....	82
11.6	ABB AC500 integration	83
11.6.1	Hardware configuration.....	83
11.6.2	CoDeSys implementation.....	84
11.6.2.1	Structured Flow Chart Implementation	84
11.6.2.1.1	Variables.....	84
11.6.2.1.2	Structured Flow chart steps	86
11.6.2.1.3	Init step	87
11.6.2.1.4	Configuration step, Write.....	87
11.6.2.1.5	Pluto units online, Read	87
11.6.2.1.6	Global Data, Read	88
11.6.2.1.7	Additional Data, Read	88
11.6.2.1.8	Packets to Pluto, Write.....	88
11.6.2.2	Task configuration.....	89
12	Data to/from Pluto	90
12.1	Pluto Status	90
12.2	Global Data from Pluto.....	90
12.3	Additional Data from Pluto	91
12.3.1	Layout of additional data	91
12.3.1.1	User defined blocks	91
12.3.1.2	Standard blocks	92
12.3.2	Programming in Pluto PLC.....	95
12.3.2.1	Function block library	95

12.3.2.2	Use of the function blocks	95
12.3.2.3	Example of usage in Pluto program	96
12.4	Data to Pluto	98
12.4.1	Enable bit	98
12.4.2	Cyclic transmission time	98
12.4.3	Timeout time	98
12.5	In PLUTO - Reception of external data from gateway	98
12.5.1	Set up in PLUTO for reception	98
12.5.2	Addressing of external data in Pluto	99
12.5.3	Connection of external variables in PLC code	100
12.5.3.1	Function block "Ext_Sig"	100
12.5.3.2	Function block "Ext_Val"	100
12.5.3.3	Function block "ExtVarBlock"	100
13	Technical data	102
13.1	Protocol specific data	102
13.2	Common data	103
14	Appendix A, gateway registers	104
14.1	Gateway registers 0 -	104
14.2	Gateway registers 100 -	105
14.3	Gateway register 200 -	106
14.4	Gateway register 300 -	107
14.5	Gateway register 400 -	108
14.6	Gateway register 500 -	108
14.7	Gateway register 600 -	109
15	Appendix B, object description EtherNet/IP	110
15.1	Definitions	110
15.2	Identity Object (01 _{HEX} - 1 Instance)	111
15.3	Message Router Object (02 _{HEX})	111
15.4	Assembly Object (04 _{HEX} - 5 Instances)	112
15.5	Connection Manager Object (06 _{HEX})	114
15.6	TCP Object (F5 _{HEX} - 1 Instance)	115
15.7	Ethernet Link Object (F6 _{HEX} - 1 Instance)	116
15.8	Application Object (64 _{HEX} - 32 Instances)	117
16	Appendix C, object description EtherCAT	120
16.1	PDO mapping	120
16.1.1	Input mapping	120
16.1.1.1	Pluto status (0x1A00)	120
16.1.1.2	Pluto global 0 - 7 (0x1A01)	120
16.1.1.3	Pluto global 8 - 15 (0x1A02)	120
16.1.1.4	Pluto global 16 - 23 (0x1A03)	120
16.1.1.5	Pluto global 24 - 31 (0x1A04)	121
16.1.1.6	Additional data 0 - 7 (0x1A05)	121
16.1.1.7	Additional data 8 - 15 (0x1A06)	121
16.1.1.8	Additional data 16 - 23 (0x1A07)	122
16.1.1.9	Additional data 24 - 31 (0x1A08)	122
16.1.2	Output mapping	122
16.1.2.1	Data to Pluto packet 1 (0x1600)	122
16.1.2.2	Data to Pluto packet 1 (0x1601)	122
16.1.2.3	Data to Pluto packet 3 (0x1602)	123
16.1.2.4	Data to Pluto packet 4 (0x1603)	123
16.2	SDO mapping	123
16.2.1	Pluto global data (0x2100)	123
16.2.2	Additional data (0x2101)	124
16.2.3	Pluto status (0x2120)	125
16.2.4	Data to Pluto (0x220y)	125
16.2.5	Configuration of additional data (0x23zz)	125
16.2.6	Configuration of Data to Pluto (0x2320)	125

16.2.7	Configuration gateway node number (0x2321).....	125
17	Appendix D, object description Sercos III.....	126
17.1	Standard Sercos IDN supported by the gateway.....	126
17.2	IDN for gateway configuration.....	129
18	Appendix E, object description PROFINET.....	132
19	Appendix F, object description Modbus TCP.....	149
19.1	Port number.....	149
19.2	Unit Identifier.....	149
19.3	Access functions.....	149
19.4	Data format.....	149
19.5	Data to Pluto.....	150
19.6	Gateway Configuration.....	150
19.7	Data to/from Pluto.....	152
19.8	Data from Pluto.....	153

1 Version information

This document is valid for:

Hardware version : 2.3

Firmware version

- GATE-EIP : 2.15
- GATE-EC : 1.3
- GATE-S3 : 1.3
- GATE-PN : 1.2
- GATE-MT : Currently not supported.

Updates in 2TLC172285M0203_C:

- Removed FTP, TFTP and web servers.
- Removed login on telnet server and renamed the server to remote server.
- Updated cyber security deployment guideline (3).
- Updated the terminal command information (6.5).
- Updated firmware update handling (6.8).
- Added PLC download via gateway using Pluto Manager (6.5.10).

2 Cyber security disclaimer

This gateway product is designed to be connected and to communicate information and data via a network interface, which should be connected to a secure network. It is your sole responsibility to provide and continuously ensure a secure connection between the product and your network or any other network (as the case may be) and to establish and maintain appropriate measures (such as but not limited to the installation of firewalls, application of authentication measures, encryption of data, installation of antivirus programs, etc.) to protect the product, the network, its system and interfaces against any kind of security breaches, unauthorized access, interference, intrusion, leakage and/or theft of data or information. ABB Ltd and its affiliates are not liable for damages and/or losses related to such security breaches, unauthorized access, interference, intrusion, leakage and/or theft of data or information.

Although ABB provides functionality testing on the products and updates that we release, you should institute your own testing program for any product updates or other major system updates (to include but not limited to code changes, configuration file changes, third party software updates or patches, hardware change out, etc.) to ensure that the security measures that you have implemented have not been compromised and system functionality in your environment is as expected.

For more information/contact regarding ABB cyber security see:

<http://www.abb.com/cybersecurity>

3 Cyber security deployment guideline

3.1 Network installation

This device shall be connected only to **private/restricted network** (see Figure 1).

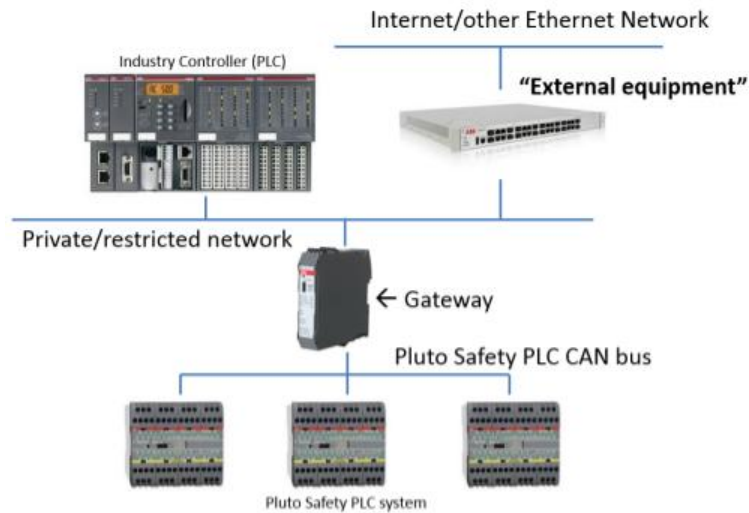

Figure 1 - Network installation

This private/restricted network can be connected for access via Internet or other network when using “**external equipment**” which can be separated devices or devices that combine **firewall, router and secure VPN functionality**. The cyber security standard of these external equipment is customer depending.



This “Cyber security deployment” guideline cannot suggest concrete products for “**external equipment**” to make a secure system setup. This must be decided along the specific project, requirements and existing infrastructure.

3.2 Limit network connections

When commission a network system it's important to address the cyber security problems by making a cyber security assessment of the system. Example of methods to reduce security vulnerabilities are:

- Network connection.
Limit the connections with routers/firewall and similar products.
- Network access control.
Add some control/limitations on the network by routers/firewall and similar products.
- Network monitor.
If needed add products which can monitor the network access and traffic.
- Network separation.
From a cyber security point and the protecting of the industry factory system it's good to separate the remote connection gateway from the factory control connected gateways as noted in Figure 2, Network separation.
- It's highly recommended to contact any cyber security personal/consulting for making a good cyber security assessment of the system.

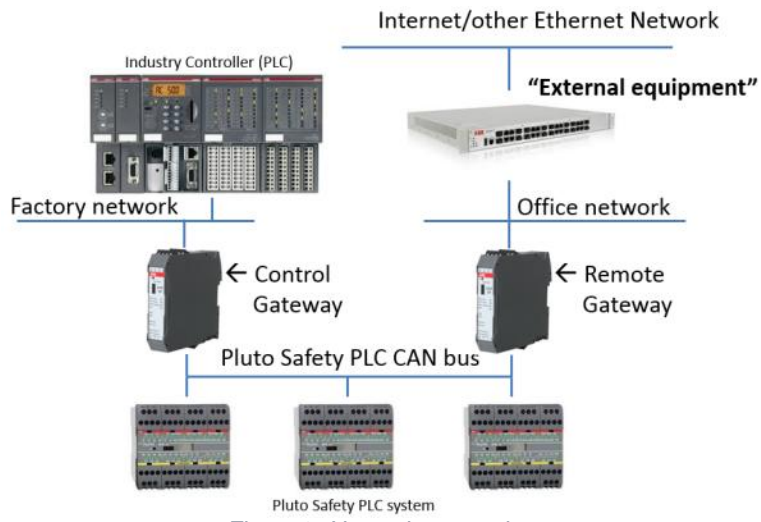

Figure 2, Network separation.

3.3 Pluto remote handling

The gateway product has together with Pluto Manager the possibility to make remote monitor and control of Pluto safety PLC system. By default this service is disabled in the gateway, but it can be enabled with the “remote” command (see 6.6.12) via the PC port (see 5.1.2.2) on the device.

The Pluto remote monitor and control is handled by the remote server (see 6.3.3) with its cyber security limitations (see 6.3.3). The connection to the remote server **don't have any authentication and the traffic is not encrypted**.

For Pluto control (Pluto PLC download and configuration) a limited access control is implemented by using the device “K” button. When the device get a commands related to any Pluto control command it will request authentication by an operator at site who shall pressing the “K” button on the device. This will give some protection against unintentional re-configuration of the Pluto system.

All commands related to configuration of the gateway itself is not supported via the remote server, e.g. only supported via the PC port.

When enable Pluto remote monitor and control handling the device shall be installed according to chapter 3.1.

The Pluto remote monitor and control behavior is depending on good network conductivity on both the Pluto bus network and the Ethernet network.

3.4 PC port usage (only local access)



The PC port (see 5.1.2.2) shall **only** be used for local terminal access to the device and are not designed for any external access handling.

4 General

The Ethernet gateways are a series of gateways for different industry Ethernet protocols. Each model is dedicated to specific industry Ethernet protocol. The following list gives a summary of the existing industry Ethernet gateways:

- GATE-EIP (2TLA020071R9000) for EtherNet/IP.
- GATE-EC (2TLA020071R9100) for EtherCAT.
- GATE-S3 (2TLA020071R9200) for Sercos III.
- GATE-PN (2TLA020071R9300) for PROFINET.
- GATE-MT (2TLA020071R9400) for Modbus TCP.

In addition to the industry Ethernet protocol each device also has support remote server (telnet).

The Pluto Safety PLC system and the gateways GATE-P1/P2, -D1/D2, -C1/C2 and -E1/E2 are described in the manual **[REF 1]**.

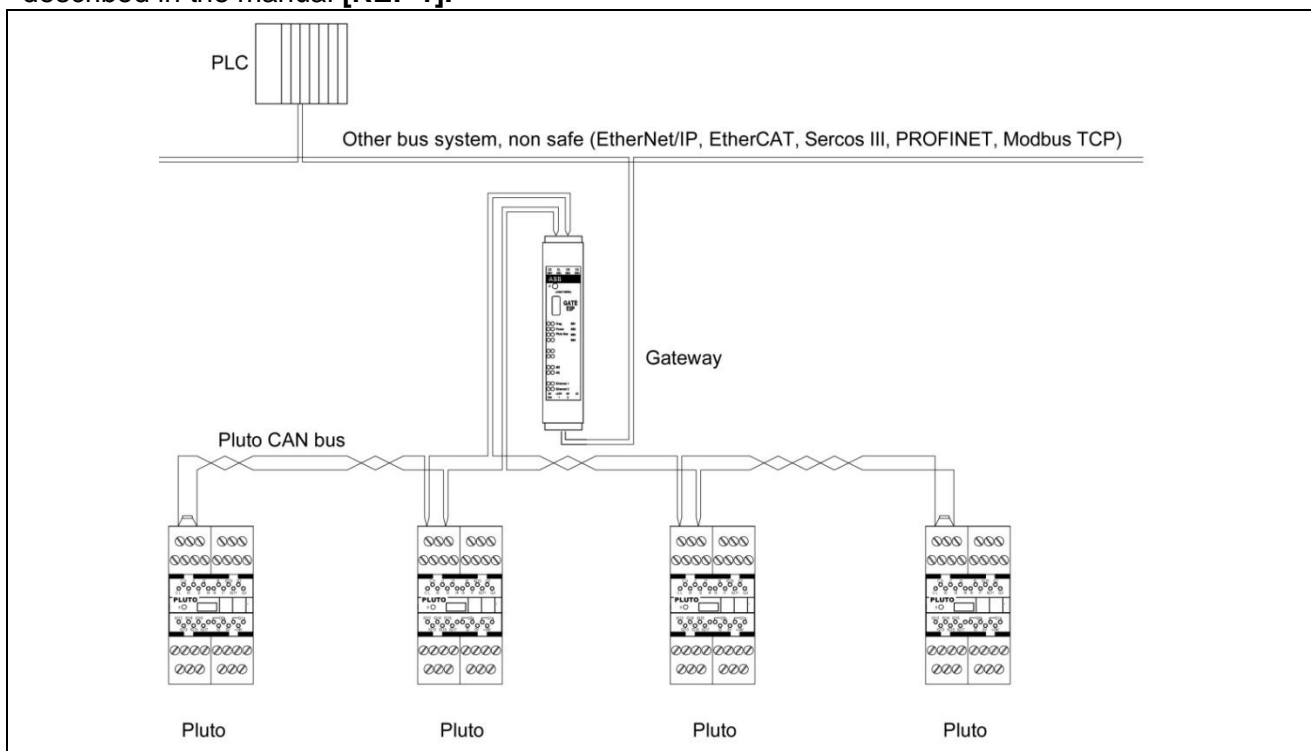

Figure 3 – Pluto system with gateway

4.1 Installation

The device shall be installed according to the information within this manual.

4.1.1 Mounting

The device shall be mounted on a 35 mm DIN rail.

For ventilation requirement the device shall be mounted vertical with minimum 20 mm free space on top/bottom side, see Figure 4.

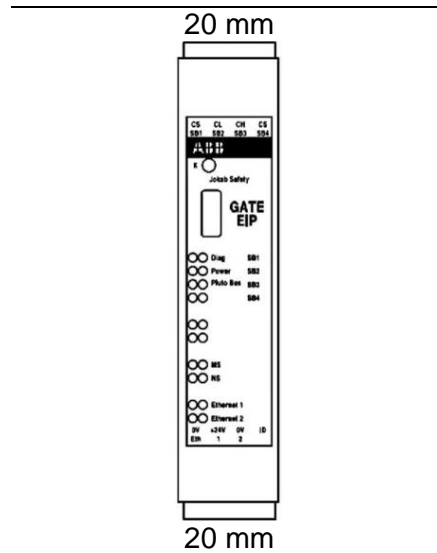

Figure 4 - Installation

The device shall be installed indoors and its enclosure is IP20. The device shall therefore be installed in cabinet for proper environmental protection, see technical data chapter 13.2.

4.1.2 Electrical installation

The device is designed for applications which fulfil IEC-EN 60204-1.

The device is powered by 24 VDC (4.8 W/0.2 A) and it has internal fuse (2 A) protection. External fuse (type C characteristic) shall be used to protect the electrical wiring (according to UL 2550 VW-1 or equivalent) to the device and the value of the fuse is depending on the installation (example 6 A type C characteristic using minimum 0.75 mm² wiring), see Figure 5.



Enclosure and terminals are able to reach temperatures above 60 °C in ambient temperatures of up to 55 °C. The electrical wiring (cables) shall therefore meet the specification of minimum 65 °C.

Boîtier et bornes sont capables d'atteindre des températures supérieures à 60 °C à des températures ambiantes jusqu'à 55 °C. Le câblage électrique (câbles) doit donc répondre à la spécification minimale de 65 °C.

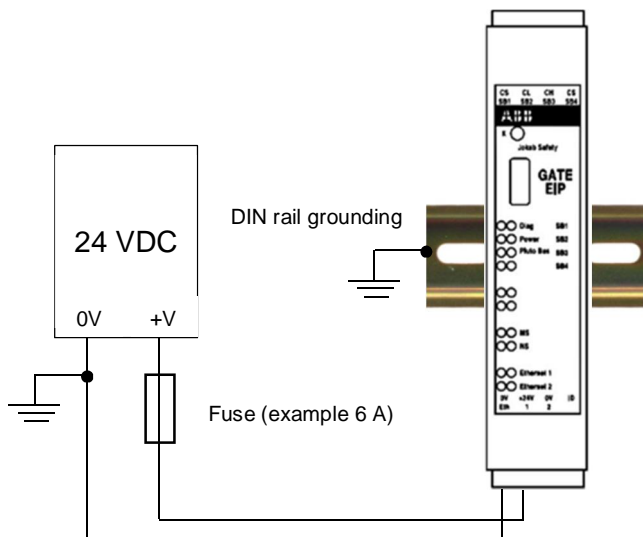

Figure 5 - 24 VDC installation

The device shall be installed in a system (the complete system) using a common ground system e.g. proper potential equalization is necessary.

When mounted on the DIN rail the device ground (0V) is connected via a capacitor to the DIN rail. Therefore the DIN rail shall be connected to the system ground, see Figure 5.

The user can install a disconnecting device if needed on the power line; or use an external fuse which is approved to be used as disconnecting device. The device also has detachable terminal blocks which can be used as a disconnection device.

4.2 Maintenance and service

The device has no requirements regarding maintenance or service.

4.3 GATE-E2 replacement

The GATE-EIP, GATE-PN and GATE-MT are functional replacements for GATE-E2 within the different industry Ethernet protocols with the following notes,

- Power terminal plug is changed, see 5.1.1.2.
- Pluto bus terminal plug is changed, see 5.1.1.2.
- There is no support for GATE-E2 local data request/response service object/function.
- There is no support for GATE-E2 pass through service object/function.
- There is no support for GATE-E2 binary server.

5 Hardware

The Ethernet gateway is housed in a 22.5 mm enclosure with 35 mm DIN rail mounting.



Figure 6 - Gateway side description

5.1 Connection, indication and switches

The gateway has connections, indications and switches on four sides (see Figure 6).

- Two connections and one configuration switch on the top side see 5.1.1.
- One connection and several indicators on the front panel, see 5.1.2.
- Three connections on the bottom side see 5.1.3.
- One connection to DIN rail, see 4.1.

5.1.1 Top side

The following connectors are positioned on the gateways top side (in order from front to back), see Figure 7 and Figure 8:

- ABB StatusBus terminal.
- Pluto bus terminal.
- Switch setting (behind cover).



Figure 7 - Terminals on the top side, with cover over the switch.



Figure 8 - Terminals on the top side, with cover removed and switch accessible.

5.1.1.1 ABB StatusBus terminal

This terminal is currently not used.
It has the following connections.

PIN	Label	Description
1	SB4	-
2	SB3	-
3	SB2	-
4	SB1	-

Table 1, ABB statusbus terminal connections.

The terminal connector is of type Phoenix MSTBT 2,5/4-ST BK BD:1-4 (Phoenix 1944259).

5.1.1.2 Pluto bus terminal

Connection to Pluto bus (CAN bus) which has a functional electrical insulation and has the connection according to the following table.

PIN	Label	Description
1	CS	Pluto bus, CAN shield.
2	CH	Pluto bus, CAN high.
3	CL	Pluto bus, CAN low.
4	CS	Pluto bus, CAN shield.

Table 2, Pluto bus terminal connections.

The terminal connector is of type Phoenix MSTBT 2,5/4-ST BK BD:1-4 (Phoenix 1944259).

5.1.1.3 Configuration switch

Behind a cover is a small DIP switch for configuration of gateway node number. (Switch pos. 1 and 2 currently not used).



Figure 9 - DIP-switch, switch numbering.

The gateway node number is set according to the table below.

Switch pos. 3	Switch pos. 4	Function
Up	Up	Gateway node number 0.
Up	Down	Gateway node number 1.
Down	Up	Gateway node number 2.
Down	Down	Gateway node number 3.

Table 3, DIP-switch – gateway node address setting.

For more information see chapter 6.1.4.2.

5.1.2 Front panel

The status indicators (LED) are located on the front panel. They are grouped in four groups for an easy overview. On the front panel there is also a pushbutton name “K” button, and a PC port connector.

5.1.2.1 “K” button

The “K” button is used for confirmation of commands which need confirmation by a person whom is at the physical site where the gateway and the Pluto system is situated.

5.1.2.2 PC port

On the front there is a four pin PC port connector where the ABB serial cable or ABB USB cable can be connected for configuration and/or troubleshooting of the gateway/Pluto system.

For connection between the gateway and a PC, one of the ABB cables and the terminal tool in ABB Pluto Manager software can be used. It's also possible to use any other terminal software and, if so, the following serial configuration shall be used:

- Baud rate 57.6 kbit/s
- Data bits 8
- Stop bits 1
- Parity none
- Flow control none



The PC port shall **only** be used for local terminal access to the device and are not secured for any external access handling.

5.1.2.3 Indicators (LED)

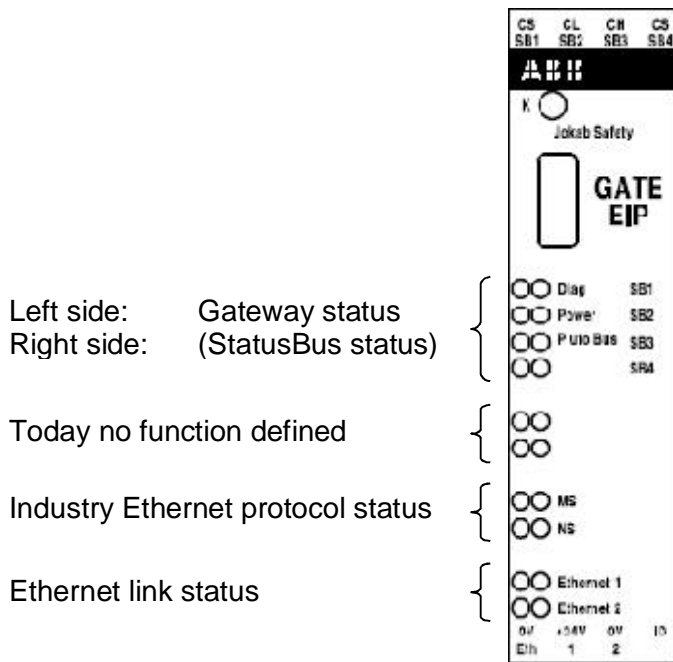

Figure 10 – Front panel indicators.

5.1.2.3.1 Gateway status

The gateway status has four indicators, of which only three has defined functions:

- The yellow “Diag” indicator will light shortly at start up but shall during normal operation not lightning. If this indicator has a steady light it is an error indication and the device shall be replaced.
- The green “Power” indicator will light when the software is running in normal non-error state.
- The green “Pluto Bus” indicator will indicate the status of the Pluto bus. For more information see chapter 6.1.3.

LED	Diag	Power	EtherNet/IP	Remark
OFF			Unit off	
GREEN Steady	OFF		Running	
YELLOW/RED Toggling			Second bootloader	Diag/Power is toggling 1 Hz. Firmware is corrupted, device replacement needed!
else			Device faulty	Device replacement needed!

Table 4, Pluto Bus indicator behavior.

5.1.2.3.2 Ethernet protocol status

The Ethernet protocol status indicators are two combined red/green indicators giving the possibility for two status indications. Each Ethernet protocol has its own defined behavior on these indicators and the behavior is defined in the chapter for each protocol.

- EtherNet/IP, see chapter 7.3.
- EtherCAT, see chapter 8.3.
- Sercos III, see chapter 9.3.
- PROFINET, see chapter 10.5.
- Modbus TCP, see chapter 11.3.

5.1.2.3.3 Ethernet link status

The Ethernet link status is two combined yellow/green indicators giving the status for each Ethernet port (see connectors on bottom side chapter 0 and 5.1.3.2). Each color has the following status information related the Ethernet port.



	Yellow indicator	Flashing light indicates Ethernet traffic on the port. E.g. no flashing indicates no Ethernet traffic on the port.
	Green indicator	Steady light indicates Ethernet connection. E.g. no light indicates no Ethernet connection.

Table 5, Ethernet link status indicator behavior.

For the green indicator the “Ethernet connection” only means there is a cable connection between the gateway and the other Ethernet device (Ethernet switch, other device or PC). It is not an indication of data traffic; this is indicated by the Ethernet protocol status indicators.

For EtherCAT there is a different coding of the link status, see chapter 8.3.1.

5.1.3 Bottom side

The following connectors are positioned on the gateways bottom side (in order from front to back):

- Ethernet port 1 (EtherCAT this is the IN port)
- Ethernet port 2 (EtherCAT this is the OUT port)
- Power terminal



Figure 11 – Bottom side terminal connections.

5.1.3.1 Ethernet port 1

This is the first Ethernet port on the gateway and it shall be the main port to connect to the network. For “daisy chain” connecting on EtherCAT this is the **input connector**.

Connection is standard RJ45 connector and the cable used shall be (minimum) according to Cat5e S/FTP (shielded cable).

5.1.3.2 Ethernet port 2

This is the second Ethernet port on the gateway and it shall be the secondary port to connect to the network. For “daisy chain” connecting on EtherCAT this is the **output connector**.

Connection is standard RJ45 connector and the cable used shall be (minimum) according to Cat5e S/FTP (shielded cable).

5.1.3.3 Power terminal

The unit is powered with 24 VDC using this terminal connection 1 and 2.

On this terminal it is possible to connect an ABB IDFIX device for future use (has today no function).

Terminal	Description
1	0V
2	+24VDC
3	0V
4	(IDFIX)

Table 6, 24 VDC power terminal connections.

The terminal connector is of type Phoenix MSTBT 2,5/4-ST BK BD:1-4 (Phoenix 1944259).

6 Common configuration

This chapter contains information about configuration which is common for all models of the Ethernet gateways described in this manual.

6.1 Pluto bus

The Pluto bus is a CAN bus which means that the connection shall follow the common rules for all CAN buses. For more information see Pluto Safety PLC hardware manual [REF 1].

6.1.1 Connection

The connector for the Pluto bus is located on the top side of the enclosure (normal mounting). If the gateway is placed at the beginning or at the end of the bus line a 120 Ω terminating resistor must be mounted. For Pluto bus terminal connection see chapter 5.1.1.2.

6.1.2 Baud rate detection

The gateway will automatically detect the baud rate when there is traffic on the Pluto bus. Once detected, the baud rate setting will remain while there is traffic on the bus. If the traffic is interrupted for 5 seconds or more the automatic baud rate detection will be restarted.

6.1.3 Status indication

The front panel LED indicator labeled Pluto bus indicates the status of the Pluto bus.



LED – Pluto bus		Description	Remark
GREEN off with short on flash		Pluto bus baud rate search.	When bus is not connected or no traffic on the bus.
GREEN on with short off flash		Pluto bus traffic detected and baud rate set.	

Table 7, Pluto bus indicator behavior.

6.1.4 Gateway node number

The gateway needs to have a node number on the Pluto bus which makes it possible for the device to send data to the Pluto system via the “Data to Pluto” function. It is possible to select node number in the range of 0 – 15.

Note: The node number setting is important to differentiate between several gateways when using “Data to Pluto”.

The gateway node number can be set in several ways; by PLC (via industry Ethernet protocol), DIP switch or terminal command. Best practice is to let the PLC set the gateway node number.

6.1.4.1 Set by PLC

The gateway node number can be set via the industry Ethernet protocol from the connected PLC master. When setting the gateway node number from the PLC it's possible to select node number in the range of 0 – 15, compared to only the range of 0 – 3 when using the DIP switch.

The configuration parameter shall be set according to the table below. The default value is 0 which means that the node number has been read from the DIP switch.

Value	Function
0 (default)	Gateway node number from DIP switch.
1	Gateway node number 0.
2	Gateway node number 1.
3	Gateway node number 2.
4	Gateway node number 3.
5	Gateway node number 4.
6	Gateway node number 5.
7	Gateway node number 6.
8	Gateway node number 7.
9	Gateway node number 8.
10	Gateway node number 9.
11	Gateway node number 10.
12	Gateway node number 11.
13	Gateway node number 12.
14	Gateway node number 13.
15	Gateway node number 14.
16	Gateway node number 15.

Table 8, Gateway node number selection via PLC.

Note: If the DIP switch is changed and the device is restarted the gateway will use the DIP switch node number until it's overwritten by the PLC.

6.1.4.2 Set by DIP switch

The gateway has a DIP switch where it is possible to set the node number of the unit to a value between 0 – 3. The value of the DIP switch is only read at power on. For more information about the DIP switch see chapter 5.1.1.3.

6.1.4.3 Set by terminal command

It is also possible to set the gateway node number via terminal command if no other ways are possible to use. For more information see chapter 6.6.2.

6.2 IP address assignment

Each type of product will at delivery have a default IP address and IP address handling according to the device industry Ethernet protocols preferred setting, for more information see chapter for the relevant industry Ethernet protocol.

For some of the Ethernet gateways (GATE-EC and GATE-PN) there is no manual assignment of the IP address. In these systems the master PLC will assign IP address to the device during commissioning. For these devices the rest of this chapter has no meaning.

The IP address can be assigned and changed in several ways,

- Static address.
 - Via the industry Ethernet protocol if this is supported.
 - Via the PC port on the front panel (see chapter 5.1.2.2).
- DHCP address setting.
- BOOTP address setting.

Normally many master units on the industry Ethernet protocol has some functions to handle and change the device IP address when connected to the network. How to do this depends on the used industry controller and no deeper information regarding this can be given here.

The second best way is to connect a terminal program to the PC port on the front panel. Via this interface it is possible to view the current IP address setting with the “bw” command. The IP address can be change by using the “ipaddr” command, see chapter 6.6.6.

6.3 Network services

The Ethernet gateways have several Ethernet network services. These services are:

Service	Default setting
ICMP Ping command.	Enabled Can't be disabled.
The device industry Ethernet Protocol.	Enabled Can't be disabled.
Remote server (telnet).	Disabled Can be enabled/disabled by the user.

Table 9, Device network services.

For cyber security reasons the remote servers are disabled by default. If the user needs the functionality with of this services it can be enabled by the user using terminal commands, see chapter 6.6.7.

It's important that the user before enabling any of the services read the relevant chapter for the service to get knowledge in the service functionality and its cyber security limitations.

6.3.1 ICMP Ping command

The device will respond on any ICMP ping command which is sent to the device IP address. This service is by default always enabled and can't be disabled.

```
C:\>ping 192.168.0.100

Pinging 192.168.0.100 with 32 bytes of data:
Reply from 192.168.0.100: bytes=32 time=2ms TTL=64
Reply from 192.168.0.100: bytes=32 time=1ms TTL=64
Reply from 192.168.0.100: bytes=32 time=1ms TTL=64
Reply from 192.168.0.100: bytes=32 time=1ms TTL=64

Ping statistics for 192.168.0.100:
    Packets: Sent = 4, Received = 4, Lost = 0 (0% loss),
Approximate round trip times in milli-seconds:
    Minimum = 1ms, Maximum = 2ms, Average = 1ms
C:\>
```

Figure 12 – Ping command.

6.3.2 Industry Ethernet Protocol

The industry Ethernet protocol is different for the different gateway models, but it is either EhterNet/IP, EtherCAT, Sercos III, PROFINET or Modbus TCP. One of these protocols will be running on the device and can't be disabled e.g. it will always be active for any connection.

6.3.3 Remote server

Cyber security is an important part when enabling this services, see chapter 2.

The remote server (telnet) is a network terminal interface similar to the PC port on the unit's front panel with limited functionality. This gives the possibility to access the unit via the network for remote monitoring and remote control of Pluto system.

By default the remote server is disabled. If the user want to use the remote server and explore this server on the network it can be enabled see chapter 6.6.7.

The remote server will listen on port number 50100 (default) and this can be changed when using the remote enable command (6.6.7).

When connecting to the remote server there is no login handling e.g. when open the connection to the remote server the user have direct access to the commands provide via this server. The commands are a subset of the commands handled by the PC port terminal connection.

The remote server connection has a 10 minutes timeout with automatic disconnection it there haven't been any inputs.

Below is an example connection and a disconnection using the exit command to the remote server. Note that not login handling is used and to exit use the exit command at the terminal input.

```
*****
EtherNet/IP gateway
*****
Name       : GATE-EIP
Article no : 2TLA020071R9000
Serial number: 4096
*****
Vendor ID  : 950
Product code : 1100
Device type : 43
*****
Software ver : 2.15
Software date: 2016-12-28
*****
ABB AB, Jokab Safety
www.abb.com/jokabsafety
*****
eip_gw> exit
```

Figure 13 – Remote server connection and disconnection.

As terminal program for the remote server use the Pluto Manager terminal window. If other terminal program is used following settings,

- Use backspace key as control-H.
- Local echo off.
- Local line editing off.

Summary: Enable the remote server **only if** you need this function.

Note no password is used for the connection!

Data traffic to/from remote server is not encrypted, e.g. clear text.

The remote server supports only **one** client connection.

6.4 Verification of configuration

Via the terminal commands (6.5) it is possible to check the status of the gateway and also to see which configuration the gateway has received from the master. For more information see the “bs”, “bw” and “bc” commands in chapter 6.5.

6.5 Terminal commands

Terminal commands can be used via a connection to the device PC port or via its remote server (if enabled). With these terminal commands it's possible to check and read the status of the unit and also update the PLC program/configuration of the Pluto system.

Each gateway has a unique prompt on the terminal output:

- GATE-EIP eip_gw>
- GATE-S3 s3_gw>
- GATE-EC ec_gw>
- GATE-PN pn_gw>
- GATE-MT mt_gw>

The prompt can be visible by pressing the ESC button. This will also end any current active commands which can be active from previous usage of the PC port.

For handling the terminal interface the "h" command will always list all valid commands see 6.5.1.

6.5.1 bg – gateway network status

With this command it is possible to see which gateways are on the Pluto bus network. It's important that all gateways on the Pluto bus have unique node number.

In the example below the "bg" command finds a gateway node number 0, which is the gateway where the command was given (connected). As gateway node number 1 there is a GATE-C2 (CANopen), number 2 is GATE-E2 (Ethernet), number 3 is GATE-D2 (DeviceNet) and as gateway node number 6 there is a GATE-EIP (EtherNet/IP).

```
eip_gw> bg
-----
Gateway 0 : Connected      Gateway 8 : -
Gateway 1 : GATE-C2        Gateway 9 : -
Gateway 2 : GATE-E2        Gateway 10 : -
Gateway 3 : GATE-D2        Gateway 11 : -
Gateway 4 : -              Gateway 12 : -
Gateway 5 : -              Gateway 13 : -
Gateway 6 : GATE-EIP        Gateway 14 : -
Gateway 7 : -              Gateway 15 : -
-----
eip_gw>
```

Figure 14 – Example gateway status (bg) command.

6.5.2 bs – Pluto bus status

With this command it's possible to check the Pluto bus settings and status.

In the example below the device is operational on the Pluto bus as gateway node number 0 and the current detected Pluto bus speed is 125 kbit/s. On the Pluto bus there is only one Pluto with node number 10 active and it's a Pluto B20 v2.

```
eip_gw> bs
-----
Gateway node number: 0
Pluto bus speed: 125 kbits
-----
Pluto 0 : -                Pluto 16 : -
Pluto 1 : -                Pluto 17 : -
Pluto 2 : -                Pluto 18 : -
Pluto 3 : -                Pluto 19 : -
Pluto 4 : -                Pluto 20 : -
Pluto 5 : -                Pluto 21 : -
```

```

Pluto 6 : -          Pluto 22 : -
Pluto 7 : -          Pluto 23 : -
Pluto 8 : -          Pluto 24 : -
Pluto 9 : -          Pluto 25 : -
Pluto 10 : B20 v2    Pluto 26 : -
Pluto 11 : -         Pluto 27 : -
Pluto 12 : -         Pluto 28 : -
Pluto 13 : -         Pluto 29 : -
Pluto 14 : -         Pluto 30 : -
Pluto 15 : -         Pluto 31 : -
-----
eip_gw>

```

Figure 15 – Example Pluto bus (bs) command.

6.5.3 bc – gateway configuration status

With this command it is possible to check and verify the configuration of the gateways application objects for data to Pluto and the additional data configuration.

Configuration and changes of this data are normally done via the configuration functions on the industry Ethernet protocol, but can also be done via terminal commands “ctp” see chapter 6.6.5, “addc” see chapter 6.6.3 and “adds” see chapter 6.6.4.

The example below of the “bc” command give that the “Data to Pluto” function is enabled for all data packet area, industry Ethernet protocol write timeout is disabled (e.g. 0 ms) and the Pluto bus update time is set to 100 ms.

For additional data there are three areas which has configuration. Area 0 is configured to receive data from Pluto node 5 with data of type “Error Code” (IO-type number 100), area 1 to receive data from Pluto node 10 with data of type “USER:01” (IO-type number 1) and area 10 will receive data from Pluto node 10 with data of type “B46” (IO-type number 101).

```

eip_gw> bc
-----
Data to Pluto
Packet area 0: Enabled
Packet area 1: Enabled
Packet area 2: Enabled
Packet area 3: Enabled
EtherNet/IP write timeout: 0 ms
Pluto bus update time: 100 ms
-----
Additional data configuration
Area Pluto IO-type | Area Pluto IO-type | Area Pluto IO-type | Area Pluto IO-type
  0      5  ErrCode |  1     10 USER: 1 |  10     10 B46   |
-----
eip_gw>

```

Figure 16 – Example gateway configuration status (bc) command.

For information about the IO-type see information. Table (and also chapter 12.3.1).

Short name	Long name	IO-type number
USER:xx	User block number xx.	1 – 99
ErrCode	Error Code.	100
B46	B46 I20-I47.	101
ASIsaf2	AS-i node 16-31 safe inputs.	102
ASI0103	AS-i node 1-3 standard input.	103
ASI0407	AS-i node 4-7 standard input.	104
ASI0811	AS-i node 8-11 standard input.	105
ASI1215	AS-i node 12-15 standard input.	106
ASI1619	AS-i node 16-19 standard input.	107

ASI2023	AS-i node 20-13 standard input.	108
ASI2427	AS-i node 24-27 standard input.	109
ASI2831	AS-i node 28-31 standard input.	110
Global	Pluto global.	111
B42 ASi	B42 AS-i I20-I47.	112
ASISaf1	AS-i node 1-15 safe input.	113
D45	D45 I20-I47.	114

Table 10, IO-type information.

6.5.4 bw – industry Ethernet protocol status

With this command it is possible to check the network settings and see status for the device Ethernet ports.

The first section displays the current status of the industry Ethernet protocol for the device. In this example it's the EtherNet/IP status as it's a GATE-EIP.

Next are network settings with the device MAC address together with the current network IP address setting (in this case using DHCP with the IP address 192.168.130.212). IP address assignment can be changed using command "ipaddr" see chapter 6.6.6.

Next section views the current status of each of the Ethernet ports.

The last section shows the current status the remote sever, if enabled also the number of connected clients to this remote server. Enable/disable of the remote server is done with the "remote" command see chapter 6.6.7.

```
eip_gw> bw
-----
EtherNet/IP status
Module Status: Device operational
Network Status: No connections
-----
MAC address   : 02:C0:FF:E0:69:FF
IP address    : 192.168.130.212
Subnetmask    : 255.255.255.0
Gateway       : 0.0.0.0
Address mode  : DHCP
-----
Port   : 1
Speed  : 100 MBITS
Duplex : FULL
Port   : 2
Speed  : NO CONNECTION
Duplex : NO CONNECTION
-----
Remote port      : ENABLED (50100)
Remote control   : DISABLED
Remote clients   : 0 (max 1)
-----
eip_gw>
```

Figure 17 – Example Ethernet protocol status (bw) command.

6.5.5 v – version information

At startup of the unit it will print out the version on the PC port. This information can also be viewed by making a "v" command. Some of the information is common for all products, but some is specific for each industry Ethernet protocol.

Below is an example of version information for a GATE-EIP product using industry Ethernet protocol EtherNet/IP. Firmware version and date will match the current firmware in the device.

```

eip_gw> v
*****
EtherNet/IP gateway
*****
Name          : GATE-EIP
Article no    : 2TLA020071R9000
Serial number: 105
*****
Vendor ID     : 950
Product code  : 1100
Device type   : 43
*****
Firmware ver  : 2.15
Firmware date: 2016-12-28
*****
ABB AB, Jokab Safety
www.abb.com/jokabsafety
*****
eip_gw>

```

Figure 18 – Example device information (v) command.

6.5.6 h – help

With the online help command it's possible to see which commands are available via the terminal connection. Depending if the terminal connection is via the PC port or the remote server the list of valid command will be different. Commands can be entered with both capital and lower case letters.

List of valid commands for both the PC port and the remote server connection,

```

eip_gw> h
I      [Pluto node[.address]]      read input
Q      [Pluto node[.address]]      read output
GM     [Pluto node[.address]]      read global memory
M      [Pluto node[.address]]      read memory bit
R      [Pluto node[.address]]      read register
DR     [Pluto node[.address]]      read double register
S      [Pluto node[.address]]      read sequence step
SM     [Pluto node[.address]]      read system memory bit
SR     [Pluto node[.address]]      read system register
SDR    [Pluto node[.address]]      read system double register
ASIS   [Pluto node[.address]]      read AS-i safety input
ASI    [Pluto node[.address[.sub]]] read AS-i input
ASQ    [Pluto node[.address[.sub]]] read AS-i output
GW     [gateway node.address]      read gateway register
ADD    [gateway node[.area]]       read gateway additional data
TO     [gateway node[.area[.reg]]]  read gateway data to Pluto
BG     view gateway nodes on Pluto bus
BS     view Pluto nodes on Pluto bus
BC     view gateway configuration
BW     view Ethernet configuration
V      view gateway version information
H      view gateway help list
EXIT   remote disconnect
eip_gw>

```

Figure 19 – List of valid commands (h) command for both PC port and remote server.

List of additional commands for PC port,

```

...
TIME   view gateway uptime
CN     change gateway node number
ADDC   clear gateway additional data configuration
ADDS   change gateway additional data configuration
CTP    change gateway data to Pluto configuration
IPADDR change gateway IP address
REMOTE enable remote monitoring of Pluto system

```

RESET	restart gateway
SYS	download new gateway firmware
DEF	restore to the default factory settings
DOUT	disconnect remote client
TEST	run gateway production test
eip_gw>	

Figure 20 – List of additional commands (h) command valid only for PC port.

6.5.7 exit – exit

When connected to the remote server (6.3.3) the command “exit” will disconnect the connection.

6.5.8 View Pluto data

It’s possible to view Pluto data via the terminal command for checking data in a selected Pluto. The list below (from the help command) shows which data can be viewed,

I	[Pluto node[.address]]	read input
Q	[Pluto node[.address]]	read output
GM	[Pluto node[.address]]	read global memory
M	[Pluto node[.address]]	read memory bit
R	[Pluto node[.address]]	read register
DR	[Pluto node[.address]]	read double register
S	[Pluto node[.address]]	read sequence step
SM	[Pluto node[.address]]	read system memory bit
SR	[Pluto node[.address]]	read system register
SDR	[Pluto node[.address]]	read system double register
ASIS	[Pluto node[.address]]	read AS-i safety input
ASI	[Pluto node[.address[.sub]]]	read AS-i input
ASQ	[Pluto node[.address[.sub]]]	read AS-i output

Figure 21 – List of valid view Pluto data commands (h) command.

The syntax for the parameters is “command[<Pluto node>[.<register[A/B]>[.subregister]]]” where Pluto node is the Pluto node number (0 – 31) and register is depending on command. For ASI and ASQ command there is also a selection of A/B-slave plus an additional sub register.

When viewing a register it’s possible to make following commands,

- Enter : step to next register (+1).
- Backspace : step to previous register (-1).
- ‘.’ : step to next register (+1).
- ‘,’ : step to previous register (-1).
- ‘h’ : switch between decimal and hexadecimal presentation.
- ESC : exit the view command.

6.5.9 View gateway data

It’s possible to check the configuration of the gateway with several commands.

GW	[gateway node.address]	read gateway register
ADD	[gateway node[.area]]	read gateway additional data
TO	[gateway node[.area[.reg]]]	read gateway data to Pluto

Figure 22 – List of valid view gateway data commands (h) command.

The gateway have most data viewed by “bs/bw/bc/add/to” commands accessible via register reading using the “gw” command and some additional information see chapter 14. By using the “gw” command it’s also possible to read this data from other gateway via the Pluto bus.

The syntax for the “gw” command is “gw<gateway node>.<register address>” to read information from any gateway node on the Pluto bus. To read information from the connected device it’s possible to use the “gw<register address>” command. E.g. if no or only one parameter is added to the command it will view the information for the connected gateway register and with no parameter

starting at register 0. If the command has two parameters then the first is the gateway node number (0 – 15) and the second it the register number. Explanation of the different registers within the gateway is listed in Appendix A, gateway registers. (Chapter 14).

When viewing a register it's possible to make the following commands,

- Enter : step to next register (+1).
- Backspace : step to previous register (-1).
- '.' : step to next register (+1).
- ',' : step to previous register (-1).
- 'h' : switch between decimal and hexadecimal presentation.
- ESC : exit the view command.

The “add” and “to” commands will view the current value of additional data area for “add” command and the current data to Pluto data with the “to” command. By these commands it's then possible to see what additional data the gateway receives from the Pluto bus, and which data will be transmitted on the Pluto bus.

6.5.10 pl/pkl – Download Pluto project

These command (pl and pkl) are command used by Pluto Manager to download Pluto project PLC via the gateway to the connected Pluto system mainly using the gateway remote server (6.3.3) function.

When processed via the remote server the download process will prompt the operator to press the gateway or Pluto device “K” button to complete the project download. This to partly secure the download processing and also have a person on site which can overview the Pluto system.

For more information about download of Pluto PLC see Pluto Manager.

It's possible to use these command direct form terminal window but it will not give the full functionality of the download which is given by using PLC download via Pluto Manager. Therefore these command are not visible via the help command.

6.6 Terminal commands (only PC port)

Commands describe in this section is only valid via the PC port for cyber security reason.

6.6.1 time – get run time

With the command “time” it is possible see run time of the gateway since last restart.

6.6.2 cn – change gateway node number

With the command “cn” it is possible to change the gateway node number on the Pluto bus. This shall normally not be needed because this configuration can normally be done via the industry Ethernet protocol.

Below is an example when the gateway node number for the unit is set to node number 10.

```
eip_gw> cn
Gateway node number 0.
Change node number in range 0-15 : 10
Gateway node number changed to 10.
eip_gw>
```

6.6.3 addc – clear additional data configuration

With the command “addc” it is possible to clear the current additional data configure, e.g. all configuration for the additional data elements like from which Pluto and which IO-type for all the additional data areas will be cleared. The status of the set configuration can be checked using the “bc” command.

```
eip_gw> addc
Clear additional data configuration [Yes/No] ? y
Configuration cleared.
eip_gw>
```

6.6.4 adds – configure additional data

With the command “adds” it is possible to configure one additional data area and by using it several times all the areas can be configured. This shall normally not be needed because this configuration shall normally be done using the industry protocol device configuration.

The example below shows setting additional area zero (0) to get data from Pluto 1 and the IO-type is 100 (e.g. error code from the selected Pluto). The status of the set configuration can be checked using the “bc” command.

```
eip_gw> adds
Configure additional data area [0-31] : 0
Receive data from Pluto node number [0-31] : 1
IO-type :
- 0 = Not used
- 1-99 = User block
- 100 = Error Code
- 101 = B46 I20-I47
- 102 = AS-i node 16-31 safe input
- 103 = AS-i node 1- 3 standard input
- 104 = AS-i node 4- 7 standard input
- 105 = AS-i node 8-11 standard input
- 106 = AS-i node 12-15 standard input
- 107 = AS-i node 16-19 standard input
- 108 = AS-i node 20-23 standard input
- 109 = AS-i node 24-27 standard input
- 110 = AS-i node 28-31 standard input
- 111 = Pluto global
- 112 = B42 AS-i I20-I47
- 113 = AS-i node 1-15 safe input
- 114 = D45 I20-I47
Select IO-type [0-255] : 100
Configuration done.
eip_gw>
```

Figure 23 – Example add additional data configuration (adds) command.

6.6.5 ctp – configure “Data to Pluto”

With the command “ctp” it is possible to configure “Data to Pluto” setting. This shall normally not be needed because this configuration shall normally be done using the industry protocol device configuration.

The example below shows a setting of data to Pluto where all packet area 0 – 3 are enabled (previously disabled), timeout is not changed (e.g. 0 ms mean timeout is disabled) and update time is changed from 100 ms to 150 ms. The status of the set configuration can be checked using the “bc” command.

```
eip_gw> ctp
Enable packet area 0 (disabled) [Yes/No]? y
Enable packet area 1 (disabled) [Yes/No]? y
Enable packet area 2 (disabled) [Yes/No]? y
Enable packet area 3 (disabled) [Yes/No]? y
EtherNet/IP write timeout (0 ms) [0-60000 ms]:
Pluto bus update time (100 ms) [0-255 ms]: 150
```



```
Setting done.  
eip_gw>
```

Figure 24 – Example change “Data to Pluto” configuration (ctp) command.

6.6.6 ipaddr – change IP address

The “ipaddr” command is not implemented on EtherCAT and PROFINET as these protocols has other protocol depending way to set the IP address of the device.

With the command “ipaddr” it’s possible to change the units IP address on the network. This IP address can be set as,

- Static, a fixed IP address set via terminal command.
- DHCP, the unit will try to get IP address from DHCP server on the network.
- BOOTP, the unit will try to get IP address using BOOTP.

Note: This will restart the gateway with the new settings!

Below is an example where the IP address is set to a static address 192.168.130.212 on a network using subnet mask of 255.255.255.0 and a default gateway of 0.0.0.0. Which setting to use depends on the network where the unit will be connected. The unit will use the new IP address after a reset/power restart. Verify the setting by using the “bw” command after the unit has been restarted.

```
eip_gw> ipaddr  
Address mode STATIC/BOOTP/DHCP (S/B/D) : s (STATIC)  
IP address : 192.168.130.212  
Subnetmask : 255.255.255.0  
Gateway : 0.0.0.0  
Change setting, making a restart.  
eip_gw>
```

Figure 25 – Example change IP address to static (ipaddr) command.

If your network/system is using DHCP it is only to change the setting to DHCP mode. After reset/power restart the unit will try to get its IP address from the networks DHCP server. Status of this can be seen using the “bw” command.

```
eip_gw> ipaddr  
Address mode STATIC/BOOTP/DHCP (S/B/D) : d (DHCP)  
Change setting, making a restart.  
eip_gw>
```

Figure 26 – Example change IP address to DHCP (ipaddr) command.

If your network/system is using BOOTP it is only to change the setting to BOOTP mode. After reset/power restart the unit will try to get its IP address using the BOOTP protocol. Status of this can be seen using the “bw” command.

```
eip_gw> ipaddr  
Address mode STATIC/BOOTP/DHCP (S/B/D) : b (BOOTP)  
Change setting, making a restart.  
eip_gw>
```

Figure 27 – Example change IP address to BOOT (ipaddr) command.

6.6.7 remote – enable/disable remote operation of Pluto system

Cyber security is an important part when enabling this function, see chapter 2.

The command “remote” is a command for enable/disable the possibility for remote operation of Pluto system by enable/disable the device network remote server. When enabling this function it’s possible to make remote operation of a Pluto system via the Ethernet (Internet) network.

When enabled the remote operation function it's important to note the network limitations for the remote server (see 6.3.3) and make appropriate actions to handle network cyber security issues in a good way (see 2).

The command will print the current status of the remote handling (see Figure 28). When a list of possible remote options is listed (see Table 11).

Selection	Description
1	Enable remote server for both control and monitor of Pluto system.
2	Enable remote server only for monitor of Pluto system.
3	Disable all remote server handling.

Table 11, Remote selections.

```
eip_gw> remote
Current setting is:
Remote handling is disabled.

Select to change remote handling:
1: Enable remote control/monitoring of Pluto system.
2: Enable remote monitoring of Pluto system.
3: Disable remote handling of Pluto system.
Select (number and enter): 1
Change setting, making a restart.
eip_gw>
```

Figure 28 – Example disable remote server (remote) command.

Note: This will restart the gateway with the new settings!

6.6.8 name – change the device station name (GATE-PN)

For GATE-PN (PROFINET) there is a device station name. This device station name is used by the PROFINET master PLC to connect to the device and assigned an IP address. This device station name is by default not set. When commissioning the device the PROFINET master PLC software has a discovery tool (DCP) to find the device on the network and with it set the device station name.

```
pn_gw> name
Current station name: oldname
New station name: newname
New station name saved!
pn_gw>
```

Figure 29 – Example change PROFINET name (name) command.

6.6.9 reset – restart the unit

With this command it is easy to restart the unit. This restart will be similar to a power restart.

```
eip_gw> reset
Reset gateway? (y/n) y
Reset...
eip_gw>
```

Figure 30 – Example restart the device (reset) command.

6.6.10 sys – firmware update of the unit

For firmware update of the device there is a sys command which is documented in a separate chapter 6.8.1.

6.6.11 def – restore factory settings

This command restore the device to the factory settings,

- IP address assignment.
- Configuration of “Data to Pluto”.
- Clear configuration of additional data.
- Set default server enable/disable settings.
- Clear device station name (GATE-PN).
- Read gateway node number from the **current** DIP switch setting.

Note: This will restart the gateway with the new settings!

```
eip_gw> def
Restore the device to the factory settings? (y/n) y
Making a restart.
eip_gw>
```

Figure 31 – Example restore factory settings (def) command.

6.6.12 dout – disconnect remote clients

With the command “dout” it is possible to disconnect any connected clients to the remote server. This can only be executed via the PC port and NOT via the remote terminal.

6.6.13 test – test command

This command is used during ABB production test and is used together with a specific test system. This command cannot be used to test the device without the test system. The command is only presented in the help listing and in this document so it’s not hidden. If this command is started the device need to be restarted via power off/on sequence to be operational.

6.7 Silent commands

For remote monitor handling via Pluto Manager the terminal also handles silent commands. These commands start with a “%” character and are not echoed back to the operator. As these commands are intended to be used only by Pluto Manager they are not documented within this manual.

6.8 Firmware update

Update the device firmware is done with Pluto Manager and a connection to the device PC port on the front panel (see 6.8.1). It's also possible to use Pluto Manger terminal window or any other terminal program (see 6.8.2).

For GATE-EC it's possible to download new firmware via the EtherCAT FoE function. How to make firmware update this way is described in a chapter under the EtherCAT protocol, see chapter 8.5.3.

6.8.1 Firmware update via PC port using Pluto Manager

Firmware update by Pluto Manager and cable connected to the PC port on the front panel. This gives an easy way to retrieve the latest firmware for the device and also a guiding tool to making the firmware update of the device without any knowledge of the gateway commands.

For this update you need the new firmware in file format with file extension “.ghx” which normally is retrieved by Pluto Manager automatically for the ABB firmware site.

Note: Normally the firmware update via the PC port will work with the device up and running the industry Ethernet protocol. It can sometimes fail and therefore it's **recommended to disconnect** the Ethernet ports during the update process.

Start Pluto Manager and under Preferences select the COM port and connect the serial cable to the PC port on the gateways front panel. Then select under tools “Update System Software” and then “Pluto System Software”, se picture below.

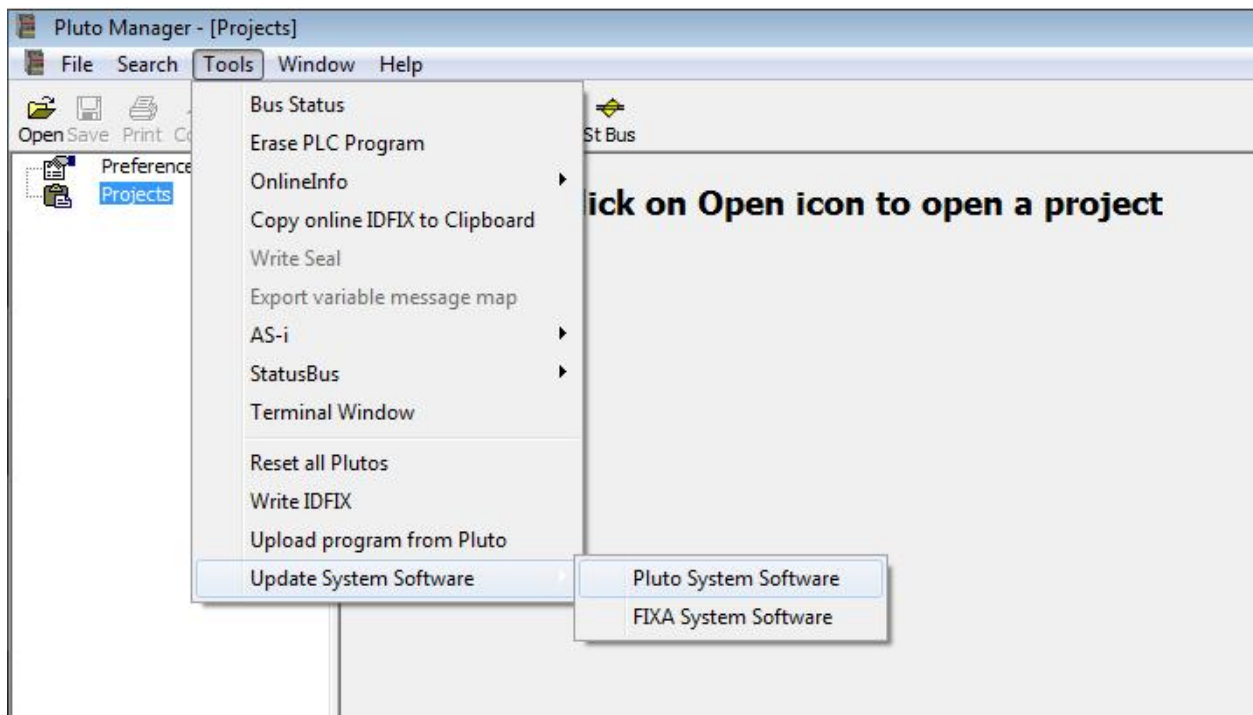

Figure 32 – Select “Pluto System Software”.

Pluto Manager will check which device is connected and then view a file selector there firmware files for the type of gateway will be shown (in this case GATE-EIP). Browse for the firmware file and then select open.

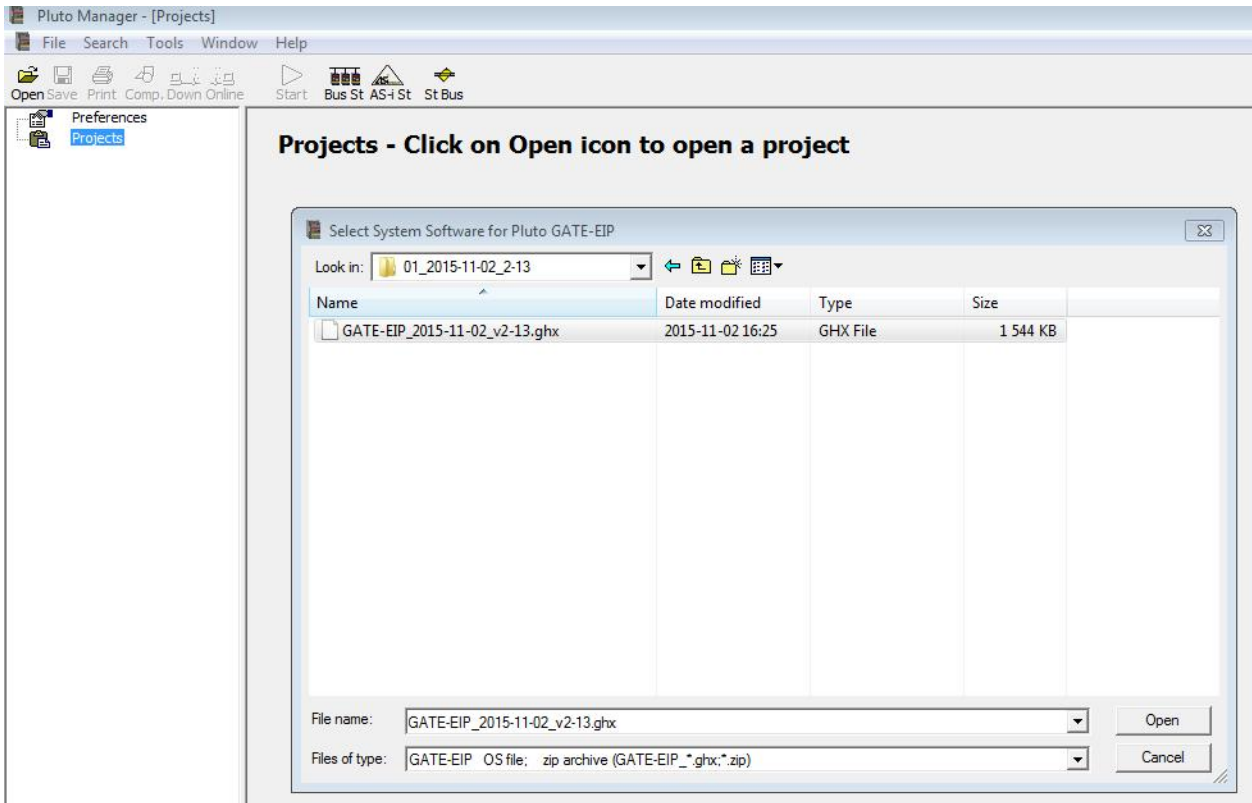

Figure 33 – Select update firmware file.

When firmware file have been selected the file will be sent to the device.

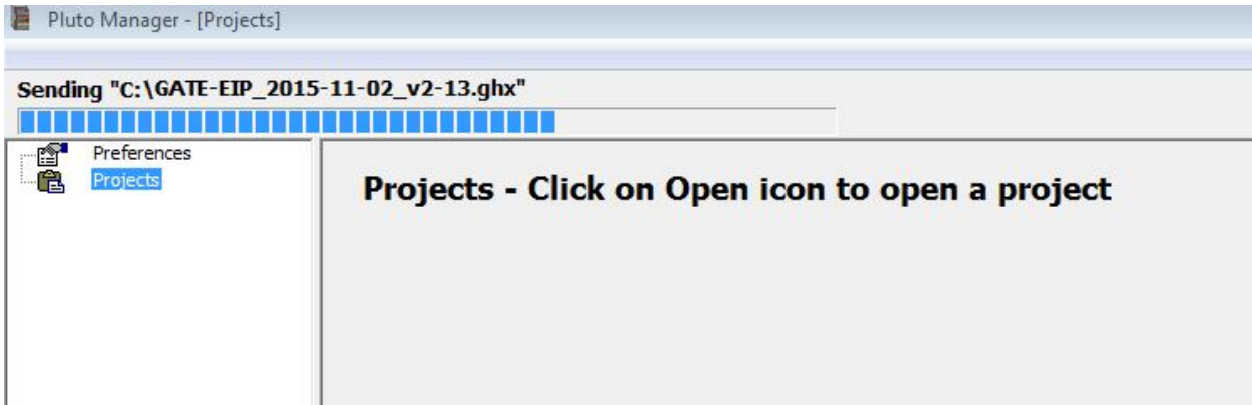

Figure 34 – Selected firmware file sent to the device.

After the firmware file have been sent will be stored in the devices FLASH memory:

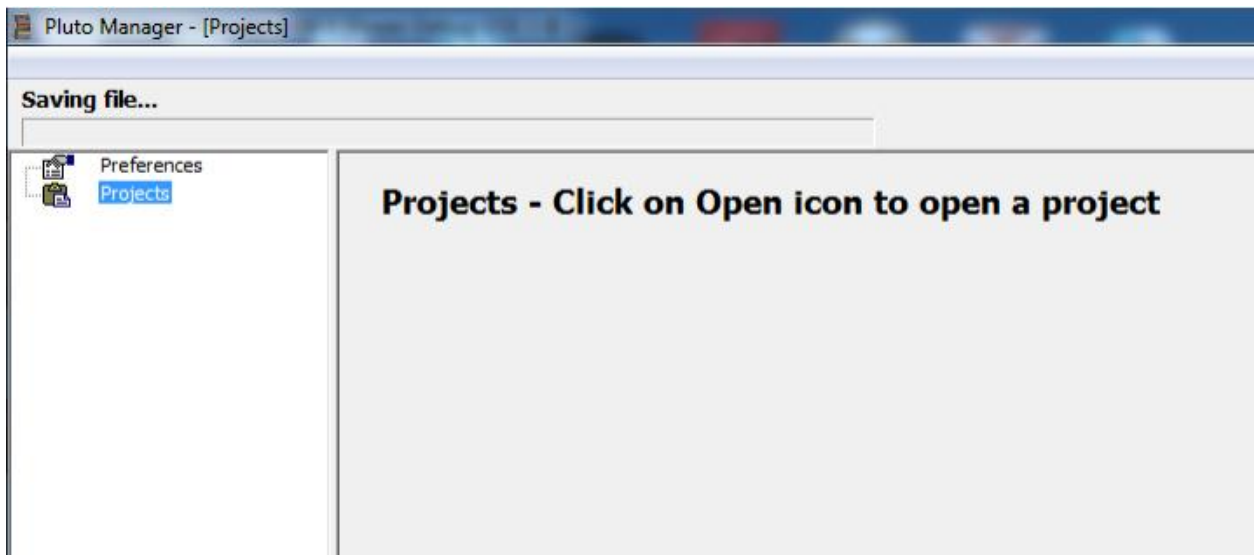

Figure 35 – Downloaded firmware file is saved on the device.

Last the device will make a restarts to activate the new firmware:

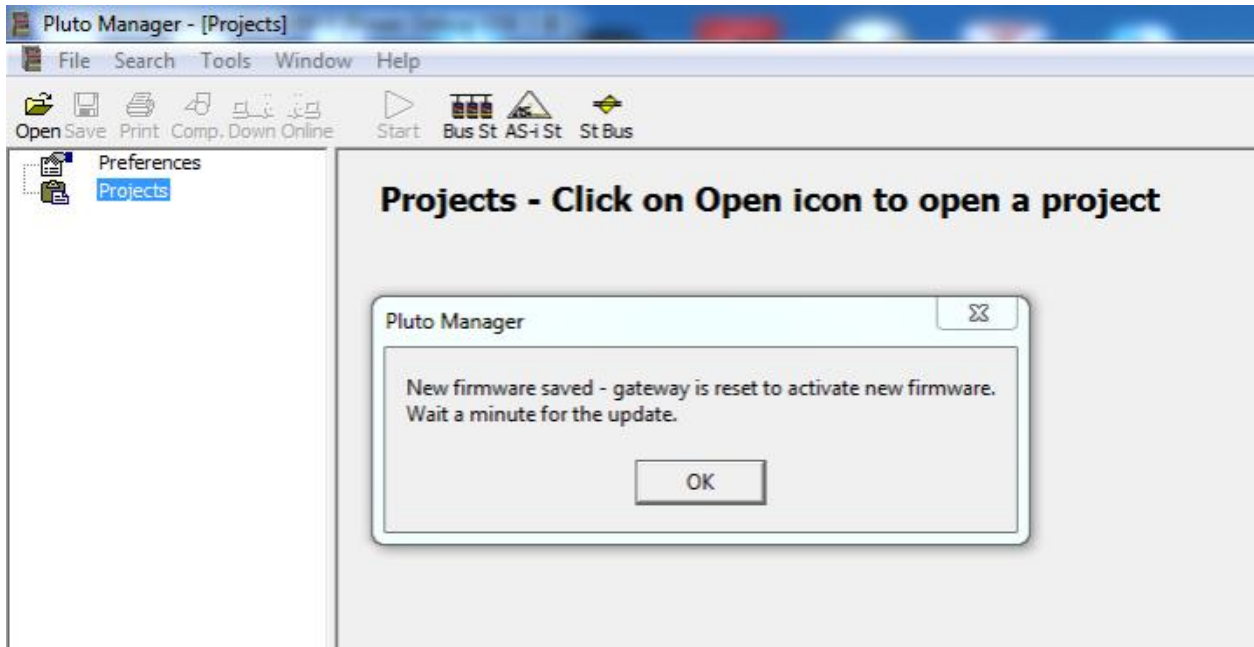

Figure 36 – Firmware file downloaded and device is restarting.

During the restart the gateway will make some checking of the downloaded file and if the file is correct it will start the execution of the new firmware.

The complete download and installation will take about 5 minutes.

6.8.2 Firmware update via PC port

The firmware of the device can be updated vid the terminal PC port interface on the front panel by using the “sys” command and upload the new firmware in file format with file extension “.ghx”.

Note: Normally the firmware update via the PC port will work with the device up and running the industry Ethernet protocol. It can sometimes fail and therefore it’s **recommended to disconnect** the Ethernet ports during the update process.

To make the firmware update enter the command “sys” and **press enter!** The prompt will tell you to send the firmware file. In Pluto Manager terminal window you select the “Send File” button and

select the correct firmware file which will have a file extension named “.ghx”. When selected the file transfer is started and it will take about 4 to 5 minutes to complete the firmware update.

```
eip_gw> sys
Send file...
Saving file...
Firmware saved, restarting.
eip_gw>
```

Figure 37 – Example firmware update using terminal (sys) command.

There is no information if the check of the downloaded file fails, the only way to verify firmware version is via the version command which is also printed on the terminal at power up.

7 GATE-EIP, EtherNet/IP

The Ethernet gateway GATE-EIP is an Ethernet gateway handling the industry Ethernet protocol EtherNet/IP which is defined by ODVA. It is build according to ODVA,

- CIP Volume 1 Edition 3.16
- CIP Volume 2 EtherNet/IP Adaption of CIP Edition 1.17
- Minimum cycle time is 10 ms.

7.1 Ethernet Connection

The gateway is connected to EtherNet/IP network using standard Ethernet connector and cable according to chapter 0 and 5.1.3.2. Both Ethernet ports have the same functionality and can be connected as desired. Normally Ethernet port 1 shall be used to connect to a network switch and Ethernet port 2 can be used to connect to other Ethernet device on the network if desired.

Each port can handle connection in both 10 and 100 Mbit/s using half or full duplex. The port automatically configures the port so it can be connected without using any special cross connected cabled.

The gateway has two Ethernet ports, and therefore it's possible to connect another device on the same Ethernet switch output by connection the other device to the second Ethernet port on the gateway. This will however increase the network traffic and may decrease the performance of the gateway device.

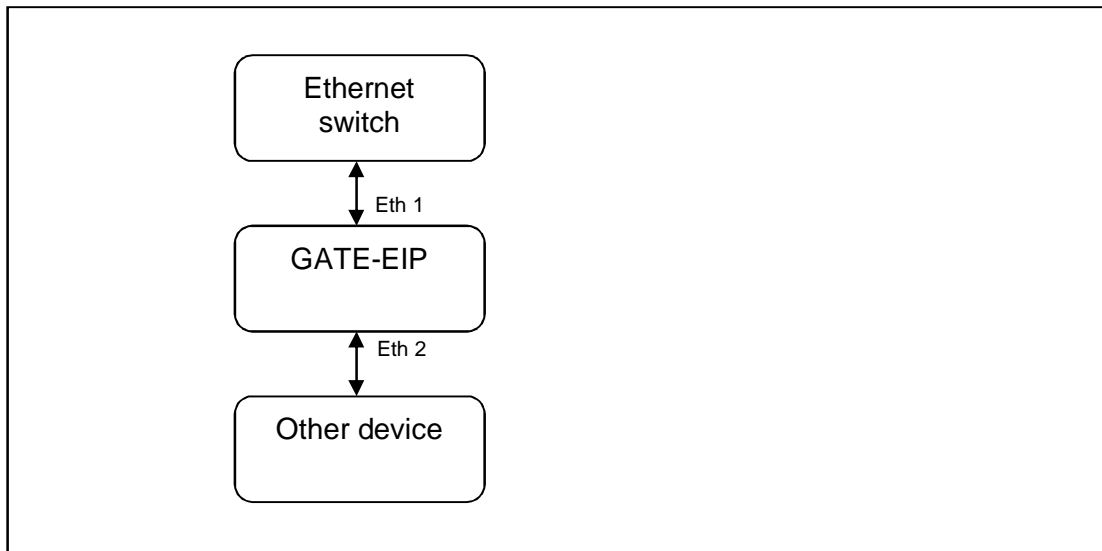

Figure 38 – EtherNet/IP, network connection via the gateway device.

7.2 IP address configuration

The default IP address assignment for the unit is using DHCP to get an IP address on the network (preferred solution for EtherNet/IP device). From many vendors using EtherNet/IP there are tools to retrieve the IP address from the device when using DHCP, see your EtherNet/IP PLC vendor documentation.

If this is not working there are other ways to configure the IP address of the device, see chapter 6.2.

7.3 Status indication

On the gateway with EtherNet/IP there are two dual color LEDs for EtherNet/IP status indications. They are named Module Status (Mod status) and Network Status (Net status). The tables below explain the indicators status information.

7.3.1 Module Status





LED		EtherNet/IP	Remark
OFF		Unit off	
GREEN flashing		Standby	
GREEN steady		Operational	
RED flashing		Minor fault	
RED steady		Major fault	
GREEN/RED flashing		Start-up/Test	

Table 12, EtherNet/IP, module status indication behavior.

7.3.2 Network Status





LED		EtherNet/IP	Remark
OFF		Unit off	If module status flashing green then the unit is missing IP address.
GREEN flashing		No connection	
GREEN steady		Connected	
RED flashing		Connection timeout	
RED steady		Duplicate IP	
GREEN/RED flashing		Start-up/Test	

Table 13, EtherNet/IP, network status indication behavior.

7.4 Service port information

The EtherNet/IP service is using several network ports on the device.

Port		Description
TCP	44818	Encapsulation messages based on TCP and Explicit messaging.
UDP	1024	Receive encapsulated CIP Service responses.
	2222	Implicit messaging (IO messaging).
	44818	Encapsulation messages based on UDP.

Table 14, EtherNet/IP, service port information.

7.5 Rockwell integration

The EtherNet/IP protocol in the gateway has been implemented according to EtherNet/IP object description in appendix chapter 15.

Example of configuration of an Allen-Bradley Rockwell system under I/O configuration and Ethernet add new module for communication of type Generic Ethernet Module,

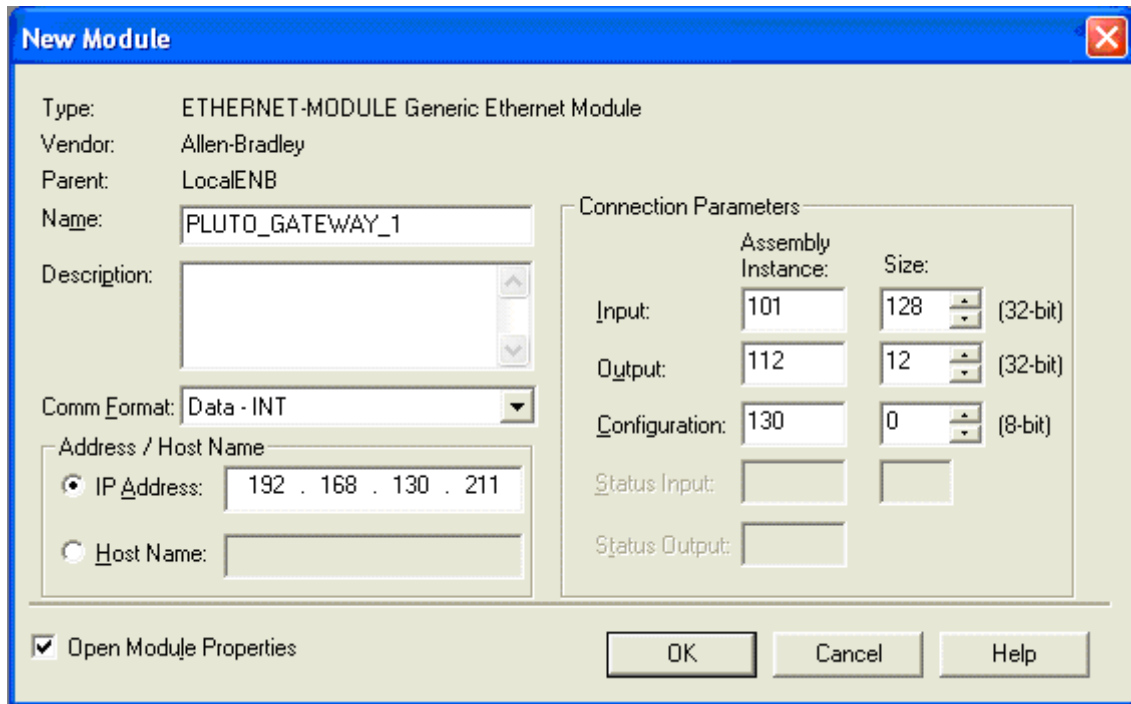

Figure 39 – EtherNet/IP, add gateway as “Generic Ethernet Module”.

Important settings are:

- Name of the Ethernet unit which will give names to the controller tags as,
 - PLUTO_GATEWAY_1:C control data
 - PLUTO_GATEWAY_1:I input data
 - PLUTO_GATEWAY_1:O output data
- IP address of the gateway (see chapter 6.2).
- Communication data size format (Comm Format, preferred format is “Data – INT”).
- Input assembly instance number and size.
- Output assembly instance number and size.
- Configuration assembly instance number and size.
- Requested Packet Interval (RPI).
- Set configuration data.

Input assembly setting

If only input data is used the size can be any of the three showed in the table. If output data is used or will maybe be used in future the size of INT shall be used.

Input data	Instance number	Instance size		
		Data - SINT	Data – INT	Data – DINT
Status Only	100	4	2	1
Data Only	101	256	128	64
Status and Data	102	260	130	65

Table 15, EtherNet/IP, selecting input data assembly.

Data structure for each instance is like the table below. For detailed information about each part see chapter 12.1 (status), 12.2 (Data from Pluto) and 12.3 (Additional Data from Pluto). The table

below indicates on which byte/word the data is located in depending on data type and used assembly number (no mapping for DINT data have been shown in this table).

Data	Data - SINT (byte)			Data - INT (word)		
	100	101	102	100	101	102
Status	0 – 3	-	0 – 3	0 – 1	-	0 – 1
Data Pluto 0	-	0 – 3	4 – 7	-	0 – 1	2 – 3
Data Pluto 1	-	4 – 7	8 – 11	-	2 – 3	4 – 5
Data Pluto 2	-	8 – 11	12 – 15	-	4 – 5	6 – 7
Data Pluto 3	-	12 – 15	16 – 19	-	6 – 7	8 – 9
Data Pluto 4	-	16 – 19	20 – 23	-	8 – 9	10 – 11
Data Pluto 5	-	20 – 23	24 – 27	-	10 – 11	12 – 13
Data Pluto 6	-	24 – 27	28 – 31	-	12 – 13	14 – 15
Data Pluto 7	-	28 – 31	32 – 35	-	14 – 15	16 – 17
Data Pluto 8	-	32 – 35	36 – 39	-	16 – 17	18 – 19
Data Pluto 9	-	36 – 39	40 – 43	-	18 – 19	20 – 21
Data Pluto 10	-	40 – 43	44 – 47	-	20 – 21	22 – 23
Data Pluto 11	-	44 – 47	48 – 51	-	22 – 23	24 – 25
Data Pluto 12	-	48 – 51	52 – 55	-	24 – 25	26 – 27
Data Pluto 13	-	52 – 55	56 – 59	-	26 – 27	28 – 29
Data Pluto 14	-	56 – 59	60 – 63	-	28 – 29	30 – 31
Data Pluto 15	-	60 – 63	64 – 67	-	30 – 31	32 – 33
Data Pluto 16	-	64 – 67	68 – 71	-	32 – 33	34 – 35
Data Pluto 17	-	68 – 71	72 – 75	-	34 – 35	36 – 37
Data Pluto 18	-	72 – 75	76 – 79	-	36 – 37	38 – 39
Data Pluto 19	-	76 – 79	80 – 83	-	38 – 39	40 – 41
Data Pluto 20	-	80 – 83	84 – 87	-	40 – 41	42 – 43
Data Pluto 21	-	84 – 87	88 – 91	-	42 – 43	44 – 45
Data Pluto 22	-	88 – 91	92 – 95	-	44 – 45	46 – 47
Data Pluto 23	-	92 – 95	96 – 99	-	46 – 47	48 – 49
Data Pluto 24	-	96 – 99	100–103	-	48 – 49	50 – 51
Data Pluto 25	-	100–103	104–107	-	50 – 51	52 – 53
Data Pluto 26	-	104–107	108–111	-	52 – 53	54 – 55
Data Pluto 27	-	108–111	112–115	-	54 – 55	56 – 57
Data Pluto 28	-	112–115	116–119	-	56 – 57	58 – 59
Data Pluto 29	-	116–119	120–123	-	58 – 59	60 – 61
Data Pluto 30	-	120–123	124–127	-	60 – 61	62 – 63
Data Pluto 31	-	124–127	128–131	-	62 – 63	64 – 65
Additional Data 00	-	128–131	132–135	-	64 – 65	66 – 67
Additional Data 01	-	132–135	136–139	-	66 – 67	68 – 69
Additional Data 02	-	136–139	140–143	-	68 – 69	70 – 71
Additional Data 03	-	140–143	144–147	-	70 – 71	72 – 73
Additional Data 04	-	144–147	148–151	-	72 – 73	74 – 75
Additional Data 05	-	148–151	152–155	-	74 – 75	76 – 77
Additional Data 06	-	152–155	156–159	-	76 – 77	78 – 79
Additional Data 07	-	156–159	160–163	-	78 – 79	80 – 81
Additional Data 08	-	160–163	164–167	-	80 – 81	82 – 83
Additional Data 09	-	164–167	168–171	-	82 – 83	84 – 85
Additional Data 10	-	168–171	172–175	-	84 – 85	86 – 86
Additional Data 11	-	172–175	176–179	-	86 – 86	88 – 89
Additional Data 12	-	176–179	180–183	-	88 – 89	90 – 91
Additional Data 13	-	180–183	184–187	-	90 – 91	92 – 93
Additional Data 14	-	184–187	188–191	-	92 – 93	94 – 95
Additional Data 15	-	188–191	192–195	-	94 – 95	96 – 97
Additional Data 16	-	192–195	196–199	-	96 – 97	98 – 99

Data	Data - SINT (byte)			Data - INT (word)		
	100	101	102	100	101	102
Additional Data 17	-	196–199	200–203	-	98 – 99	100–101
Additional Data 18	-	200–203	204–207	-	100–101	102–103
Additional Data 19	-	204–207	208–211	-	102–103	104–105
Additional Data 20	-	208–211	212–215	-	104–105	106–107
Additional Data 21	-	212–215	216–219	-	106–107	108–109
Additional Data 22	-	216–219	220–223	-	108–109	110–111
Additional Data 23	-	220–223	224–227	-	110–111	112–113
Additional Data 24	-	224–227	228–231	-	112–113	114–115
Additional Data 25	-	228–231	232–235	-	114–115	116–117
Additional Data 26	-	232–235	236–239	-	116–117	118–119
Additional Data 27	-	236–239	240–243	-	118–119	120–121
Additional Data 28	-	240–243	244–247	-	120–121	122–123
Additional Data 29	-	244–247	248–251	-	122–123	124–125
Additional Data 30	-	248–251	252–255	-	124–125	126–127
Additional Data 31	-	252–255	256–259	-	126–127	128–129

Table 16, EtherNet/IP, input data allocation.

Output assembly setting

It is recommended to only use INT data for output data because output data is 16-bits registers. For description of “Data to Pluto” structure see chapter 12.4.

Input data	Instance number	Instance size		
		Data - SINT	Data – INT	Data – DINT
Data to Pluto (Output data)	112	-	12	-
Input only (No data to Pluto)	128	0	0	0

Table 17, EtherNet/IP, selecting output data assembly.

Configuration assembly setting

There is no configuration data so size is zero.

Input data	Instance number	Instance size		
		Data - SINT	Data – INT	Data – DINT
Configuration data	130	0	0	0

Table 18, EtherNet/IP, selecting no data assembly.

Requested Packet Interval (RPI)

Under the connection tab the Requested Packet Interval (RPI) shall be set to desired value, but it shall not be less than 10 ms.

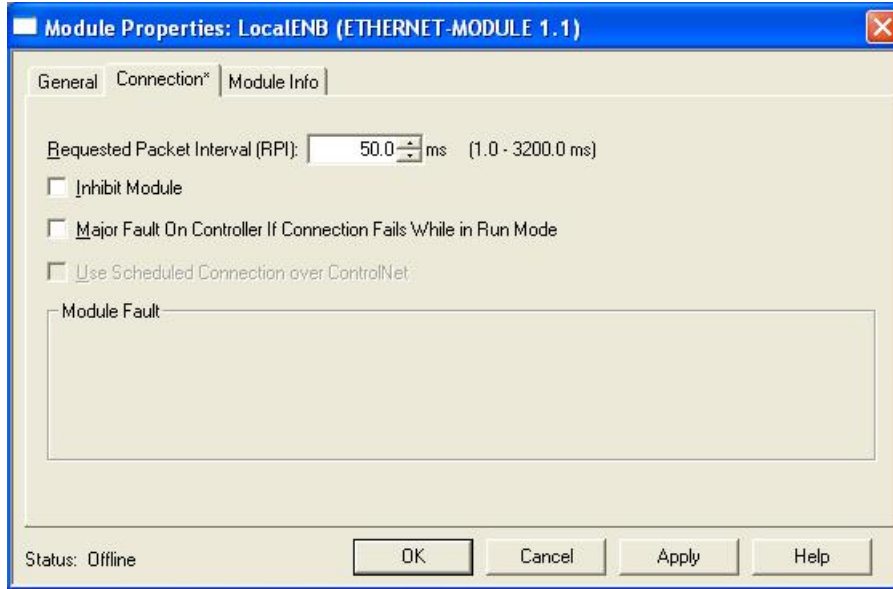

Figure 40 – EtherNet/IP, select RPI (not less than 10 ms).

Set configuration data

After the PLC has established connection and/or done a reconnection to the gateway, the PLC can/shall send configuration messages to the gateway if needed. It is possible to send configuration data by using message blocks. Configuration settings are related to “Data to Pluto” information to enable packet area (attribute 0x10) and timeout (attribute 0x11), see example below and chapter 12.4.

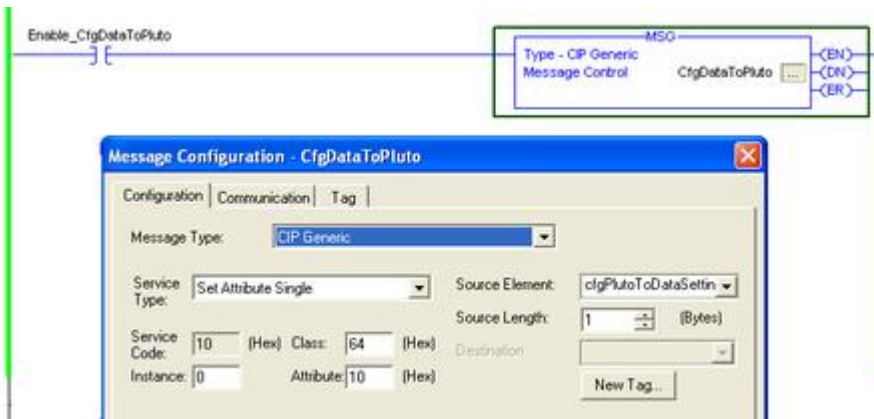

Figure 41 – EtherNet/IP, add configuration command.

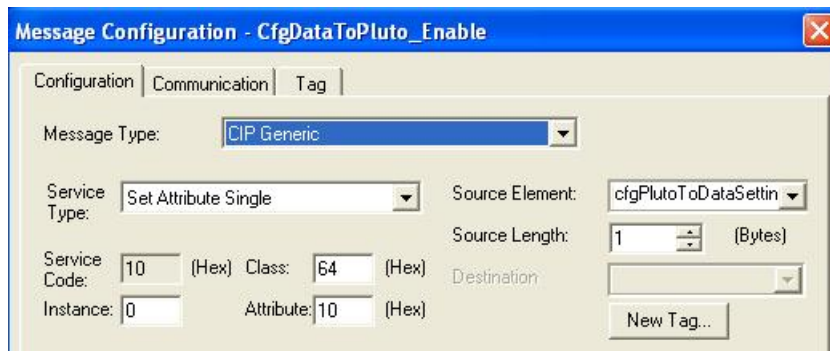

Figure 42 – EtherNet/IP, example set enable bits by a write to attribute 0x10.

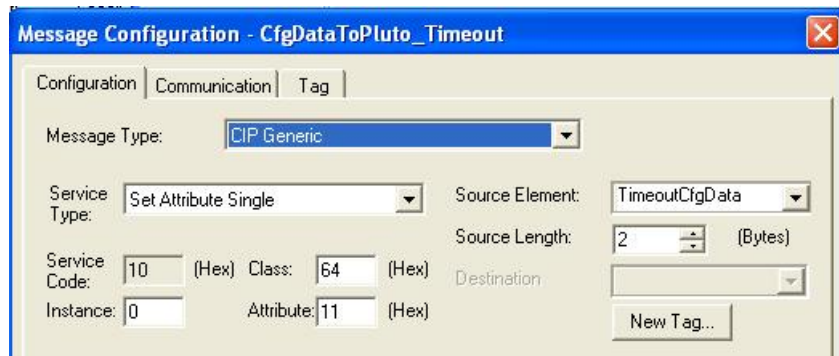

Figure 43 – EtherNet/IP, example set enable bits by a write to attribute 0x11.

There is also configuration get/set for additional data via the same feature but using other attribute numbers in the message. For more information see appendix and also chapter 12.3.

8 GATE-EC, EtherCAT

The Ethernet gateway GATE-EC is an Ethernet gateway handling the industry Ethernet protocol EtherCAT which is defined by EtherCAT Technology Group and build according to,

- IEC 61158 Part 2-6 Type 12 documents (ETG.1000 V1.0.3).
- EtherCAT Protocol Enhancements (ETG.1020 V1.0.0).
- Minimum cycle time is 500 µs.
- The device support FoE (File transfer over EtherCAT) see chapter 5.4.3.
- The device support EoE (Ethernet over EtherCAT) for access to remote server.
- Support for hot connect (second slave address, also used for Omron PLC).

For more information see EtherCAT bus master documentation how to use these functions.

8.1 Ethernet Connection

The gateway is connected to EtherCAT network using standard Ethernet connector and cable according to chapter 0 and 5.1.3.2. As EtherCAT is a bus where each device has an input and output side the “Eth 1” port is the input port (IN) and “Eth 2” is the output port (OUT), see figure below.

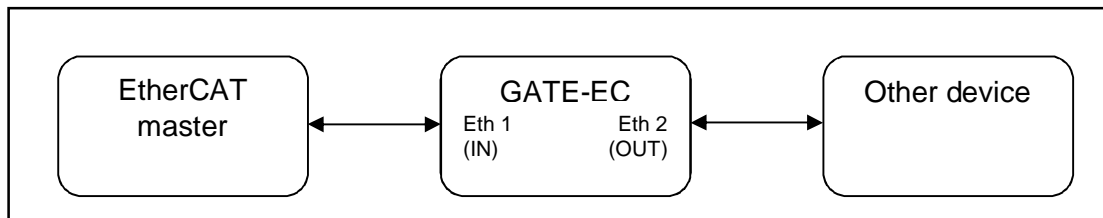

Figure 44 – EtherCAT, network connection.

8.2 IP address configuration

The IP address assignment for the unit is managed by the EtherCAT master and can't be changed in any other ways.

8.3 Status indication

On the gateway with EtherCAT there are two LEDs for link indication and two LEDs for EtherCAT status indications. The link LEDs are named “Ethernet 1” and “Ethernet 2”. The status LEDs are named RUN and ERR. The table below explains the indicators status information.

8.3.1 Link/Activity



LED		EtherCAT	Remark
OFF		Port closed	
GREEN Flickering		Port open	Link and activity.
GREEN Steady		Port open	Link and no activity.

Table 19, EtherCAT, Ethernet link status indication behavior.

8.3.2 RUN Status





LED		EtherCAT	Remark
OFF		Init	
GREEN Blinking		Pre-Operational	
GREEN Single Flash		Safe-Operational	
GREEN Flickering		Initialization or Bootstrap	
GREEN Steady		Operational	

Table 20, EtherCAT, RUN status indication behavior.

8.3.3 Error Status





LED		EtherCAT	Remark
OFF		No error	
RED Blinking		Invalid Configuration	
RED Single Flash		Unsolicited State Change	
RED Double Flash		Application Watchdog Timeout	
RED Flickering		Booting Error	
RED Steady		PDI Watchdog Timeout	

Table 21, EtherCAT, ERROR status indication behavior.

8.3.4 LED handling

Indicator states	Definition
On	The indicator shall be constantly on.
Off	The indicator shall be constantly off.
Flickering	The indicator shall turn on and off iso-phase with a frequency of 10 Hz: on for 50 ms and off for 50 ms.
Blinking	The indicator shall turn on and off iso-phase with a frequency of 2.5 Hz: on for 200 ms followed by off for 200 ms.
Single Flash	The indicator shall show one short flash (200 ms) followed by a long off phase (1000 ms).
Double Flash	The indicator shall show a sequence of two short flashes (200 ms), separated by an off phase (200 ms), and followed by a long off phase (1000 ms).

Table 22, EtherCAT, define of different type of LED indication behavior.

8.4 ABB AC500 integration

This example shows a simple implementation of the Gate-EC in an ABB AC500 PLC, using a CM579-ETHCAT communication module. It doesn't show any actual program, just how the "to" and "from" variables via the gateway Gate-EC are setup. Automation Builder V1.1.1717 was used. All settings are default unless otherwise said so.

8.4.1 Device repository and XML file

In Automation Builder under the Tools menu, start the "Device Repository" tool.

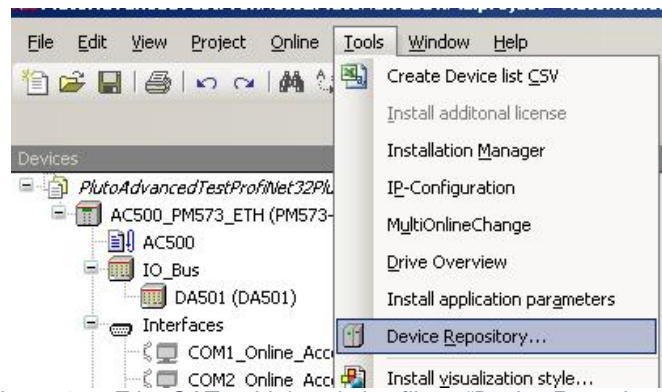

Figure 45 – EtherCAT, add description file to "Device Repository..."

Use the "Install..." button and point at the file's location. Please note that it is included in Pluto Manager, under the Help menu. The result is shown in the picture below.

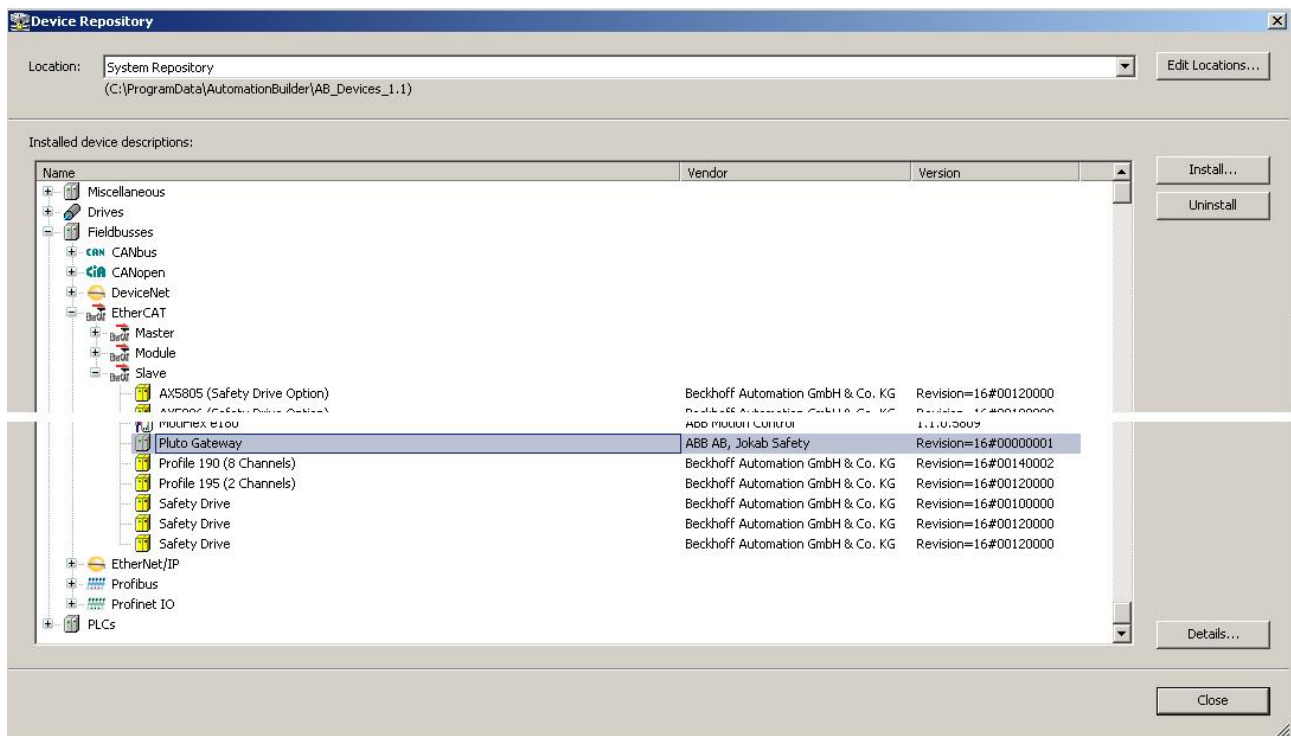

Figure 46 – EtherCAT, view the installed device as "Pluto Gateway".

8.4.2 Hardware

After adding the CM579-ETHCAT communication module right-click and add the Gate-EC object.

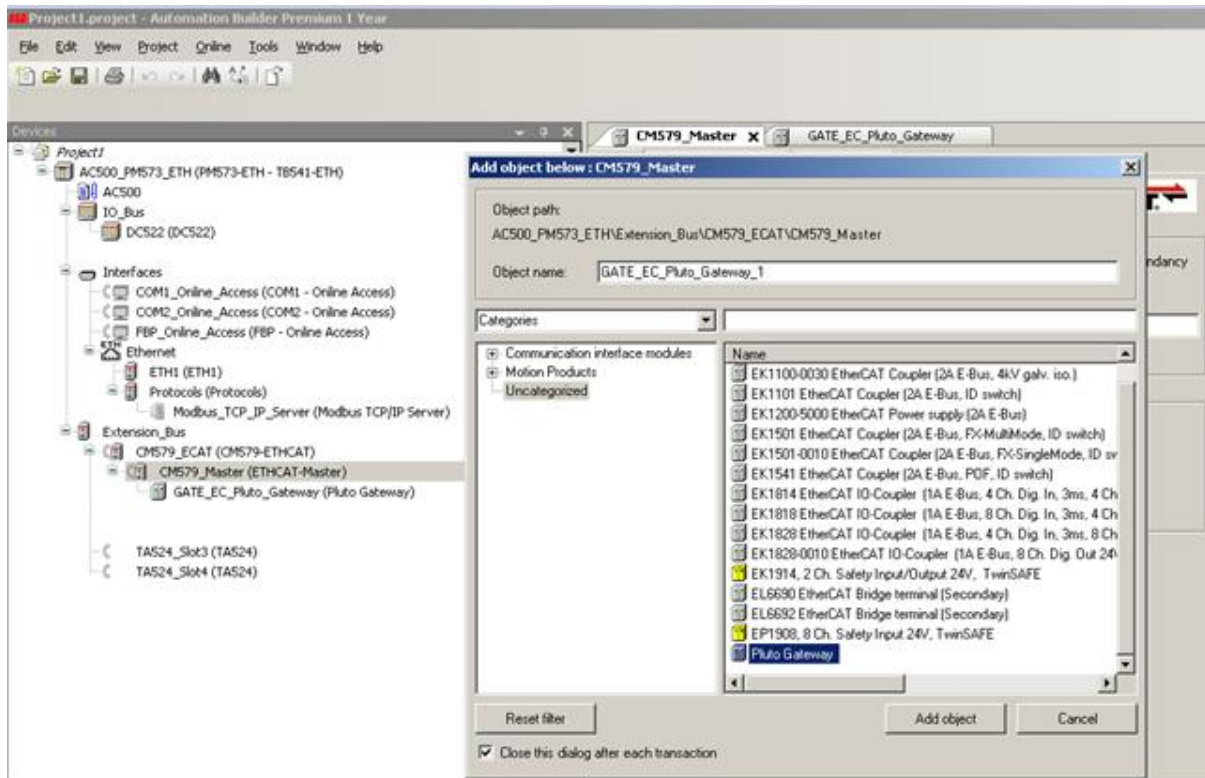

Figure 47 – EtherCAT, select the “Pluto Gateway” device.

8.4.3 CM_579 Master

Settings for the CM579-ETHCAT master.

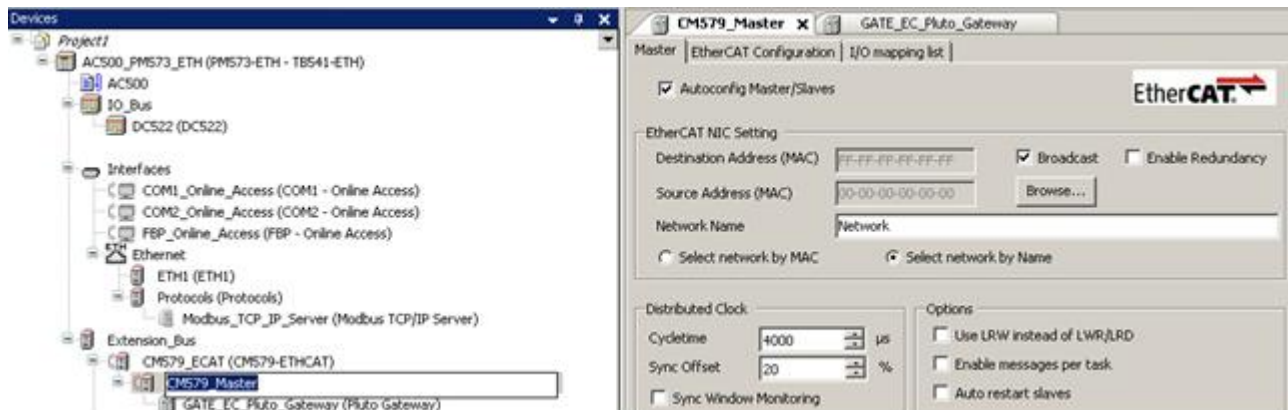

Figure 48 – EtherCAT, select the CM579-ETHCAT master.

8.4.4 Gate_EC_Pluto_Gateway

The picture below shows the default settings used for the gateway.

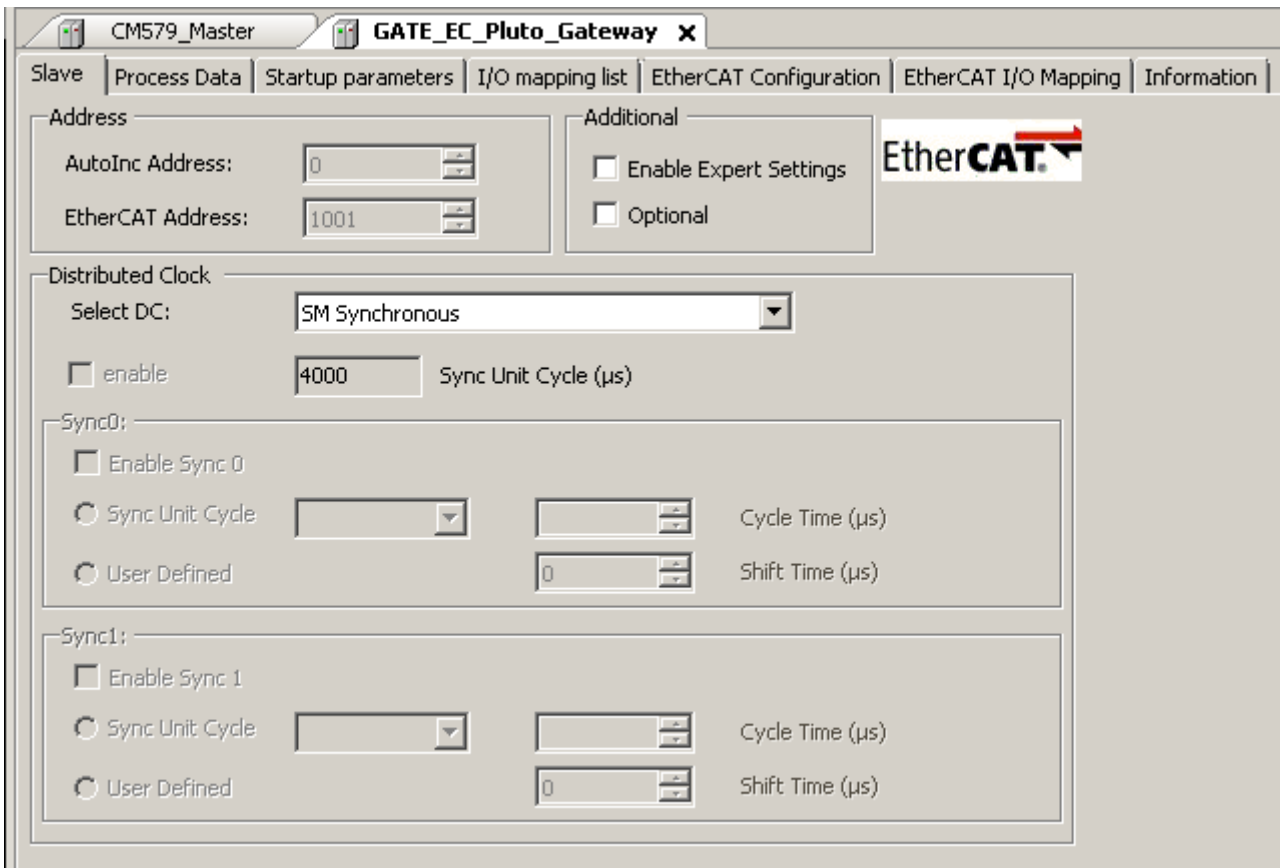

Figure 49 – EtherCAT, “Pluto Gateway” default setting.

In this example everything has been included but it doesn’t have to be so.

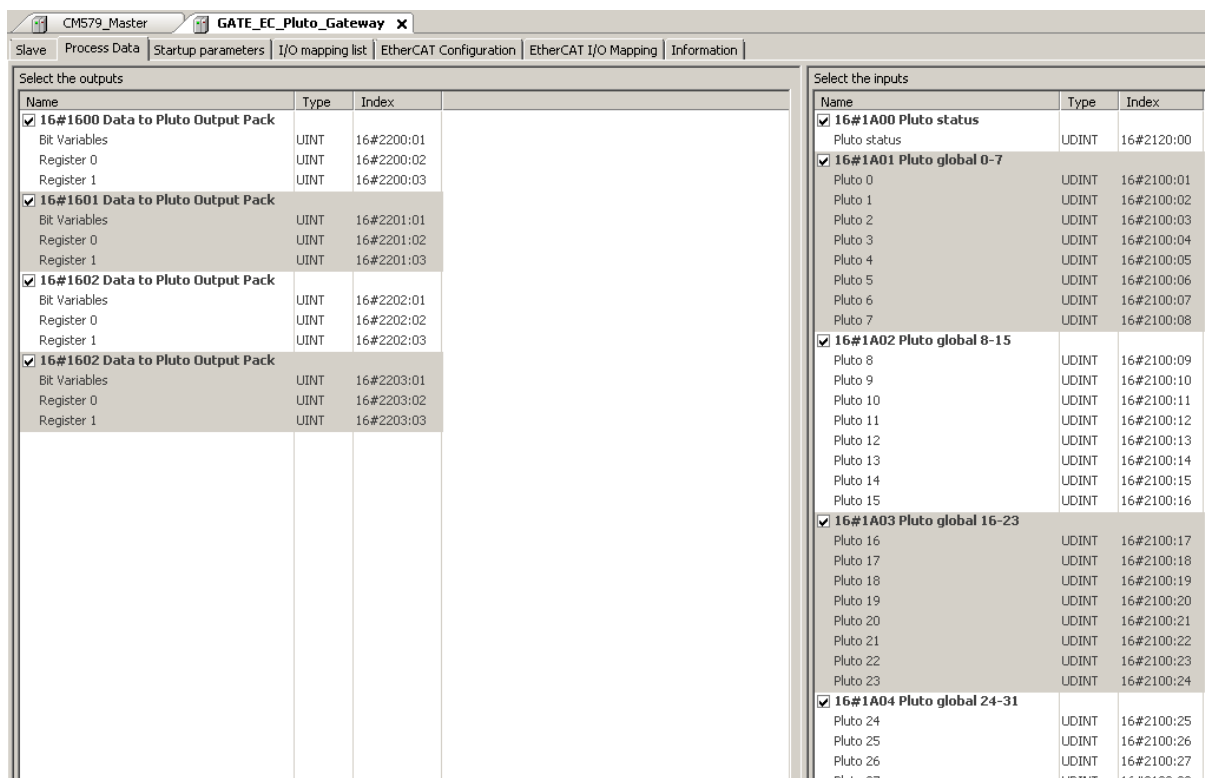

Figure 50 – EtherCAT, example of including all input and outputs.

8.4.5 Startup parameters

It is advised to include all “Additional Data” areas so they are initialized to zero at startup.

Line	Index:Subindex	Name	Value	Bitlength	Abort if error	Jump to line if error	Next line	Comment
1	16#2300:16#01	AD00 Pluto node	1	8	<input type="checkbox"/>	<input type="checkbox"/>	0	
2	16#2300:16#02	AD00 IO-Type	100	8	<input type="checkbox"/>	<input type="checkbox"/>	0	
3	16#2301:16#01	AD01 Pluto node	1	8	<input type="checkbox"/>	<input type="checkbox"/>	0	
4	16#2301:16#02	AD01 IO-Type	1	8	<input type="checkbox"/>	<input type="checkbox"/>	0	
5	16#2302:16#01	AD02 Pluto node	1	8	<input type="checkbox"/>	<input type="checkbox"/>	0	
6	16#2302:16#02	AD02 IO-Type	0	8	<input type="checkbox"/>	<input type="checkbox"/>	0	
7	16#2303:16#01	AD03 Pluto node	0	8	<input type="checkbox"/>	<input type="checkbox"/>	0	
8	16#2303:16#02	AD03 IO-Type	0	8	<input type="checkbox"/>	<input type="checkbox"/>	0	
9	16#2304:16#01	AD04 Pluto node	0	8	<input type="checkbox"/>	<input type="checkbox"/>	0	
10	16#2304:16#02	AD04 IO-Type	0	8	<input type="checkbox"/>	<input type="checkbox"/>	0	
11	16#2305:16#01	AD05 Pluto node	0	8	<input type="checkbox"/>	<input type="checkbox"/>	0	
12	16#2305:16#02	AD05 IO-Type	0	8	<input type="checkbox"/>	<input type="checkbox"/>	0	
13	16#2306:16#01	AD06 Pluto node	0	8	<input type="checkbox"/>	<input type="checkbox"/>	0	
14	16#2306:16#02	AD06 IO-Type	0	8	<input type="checkbox"/>	<input type="checkbox"/>	0	
15	16#2307:16#01	AD07 Pluto node	0	8	<input type="checkbox"/>	<input type="checkbox"/>	0	
16	16#2307:16#02	AD07 IO-Type	0	8	<input type="checkbox"/>	<input type="checkbox"/>	0	
17	16#2308:16#01	AD08 Pluto node	0	8	<input type="checkbox"/>	<input type="checkbox"/>	0	
18	16#2308:16#02	AD08 IO-Type	0	8	<input type="checkbox"/>	<input type="checkbox"/>	0	
19	16#2309:16#01	AD09 Pluto node	0	8	<input type="checkbox"/>	<input type="checkbox"/>	0	
20	16#2309:16#02	AD09 IO-Type	0	8	<input type="checkbox"/>	<input type="checkbox"/>	0	
21	16#230A:16#01	AD10 Pluto node	0	8	<input type="checkbox"/>	<input type="checkbox"/>	0	
22	16#230A:16#02	AD10 IO-Type	0	8	<input type="checkbox"/>	<input type="checkbox"/>	0	
23	16#230B:16#01	AD11 Pluto node	0	8	<input type="checkbox"/>	<input type="checkbox"/>	0	
24	16#230B:16#02	AD11 IO-Type	0	8	<input type="checkbox"/>	<input type="checkbox"/>	0	
25	16#230C:16#01	AD12 Pluto node	0	8	<input type="checkbox"/>	<input type="checkbox"/>	0	
26	16#230C:16#02	AD12 IO-Type	0	8	<input type="checkbox"/>	<input type="checkbox"/>	0	
27	16#230D:16#01	AD13 Pluto node	0	8	<input type="checkbox"/>	<input type="checkbox"/>	0	
28	16#230D:16#02	AD13 IO-Type	0	8	<input type="checkbox"/>	<input type="checkbox"/>	0	
29	16#230E:16#01	AD14 Pluto node	0	8	<input type="checkbox"/>	<input type="checkbox"/>	0	
30	16#230E:16#02	AD14 IO-Type	0	8	<input type="checkbox"/>	<input type="checkbox"/>	0	
31	16#230F:16#01	AD15 Pluto node	0	8	<input type="checkbox"/>	<input type="checkbox"/>	0	
32	16#230F:16#02	AD15 IO-Type	0	8	<input type="checkbox"/>	<input type="checkbox"/>	0	
33	16#2310:16#01	AD16 Pluto node	0	8	<input type="checkbox"/>	<input type="checkbox"/>	0	
34	16#2310:16#02	AD16 IO-Type	0	8	<input type="checkbox"/>	<input type="checkbox"/>	0	
35	16#2311:16#01	AD17 Pluto node	0	8	<input type="checkbox"/>	<input type="checkbox"/>	0	
36	16#2311:16#02	AD17 IO-Type	0	8	<input type="checkbox"/>	<input type="checkbox"/>	0	
37	16#2312:16#01	AD18 Pluto node	0	8	<input type="checkbox"/>	<input type="checkbox"/>	0	
38	16#2312:16#02	AD18 IO-Type	0	8	<input type="checkbox"/>	<input type="checkbox"/>	0	
39	16#2313:16#01	AD19 Pluto node	0	8	<input type="checkbox"/>	<input type="checkbox"/>	0	
40	16#2313:16#02	AD19 IO-Type	0	8	<input type="checkbox"/>	<input type="checkbox"/>	0	
41	16#2314:16#01	AD20 Pluto node	0	8	<input type="checkbox"/>	<input type="checkbox"/>	0	
42	16#2314:16#02	AD20 IO-Type	0	8	<input type="checkbox"/>	<input type="checkbox"/>	0	
43	16#2315:16#01	AD21 Pluto node	0	8	<input type="checkbox"/>	<input type="checkbox"/>	0	
44	16#2315:16#02	AD21 IO-Type	0	8	<input type="checkbox"/>	<input type="checkbox"/>	0	
45	16#2316:16#01	AD22 Pluto node	0	8	<input type="checkbox"/>	<input type="checkbox"/>	0	
46	16#2316:16#02	AD22 IO-Type	0	8	<input type="checkbox"/>	<input type="checkbox"/>	0	
47	16#2317:16#01	AD23 Pluto node	0	8	<input type="checkbox"/>	<input type="checkbox"/>	0	
48	16#2317:16#02	AD23 IO-Type	0	8	<input type="checkbox"/>	<input type="checkbox"/>	0	
49	16#2318:16#01	AD24 Pluto node	0	8	<input type="checkbox"/>	<input type="checkbox"/>	0	
50	16#2318:16#02	AD24 IO-Type	0	8	<input type="checkbox"/>	<input type="checkbox"/>	0	
51	16#2319:16#01	AD25 Pluto node	0	8	<input type="checkbox"/>	<input type="checkbox"/>	0	
52	16#2319:16#02	AD25 IO-Type	0	8	<input type="checkbox"/>	<input type="checkbox"/>	0	
53	16#231A:16#01	AD26 Pluto node	0	8	<input type="checkbox"/>	<input type="checkbox"/>	0	
54	16#231A:16#02	AD26 IO-Type	0	8	<input type="checkbox"/>	<input type="checkbox"/>	0	
55	16#231B:16#01	AD27 Pluto node	0	8	<input type="checkbox"/>	<input type="checkbox"/>	0	
56	16#231B:16#02	AD27 IO-Type	0	8	<input type="checkbox"/>	<input type="checkbox"/>	0	
57	16#231C:16#01	AD28 Pluto node	0	8	<input type="checkbox"/>	<input type="checkbox"/>	0	
58	16#231C:16#02	AD28 IO-Type	0	8	<input type="checkbox"/>	<input type="checkbox"/>	0	
59	16#231D:16#01	AD29 Pluto node	0	8	<input type="checkbox"/>	<input type="checkbox"/>	0	
60	16#231D:16#02	AD29 IO-Type	0	8	<input type="checkbox"/>	<input type="checkbox"/>	0	
61	16#231E:16#01	AD30 Pluto node	0	8	<input type="checkbox"/>	<input type="checkbox"/>	0	
62	16#231E:16#02	AD30 IO-Type	0	8	<input type="checkbox"/>	<input type="checkbox"/>	0	
63	16#231F:16#01	AD31 Pluto node	0	8	<input type="checkbox"/>	<input type="checkbox"/>	0	
64	16#231F:16#02	AD31 IO-Type	0	8	<input type="checkbox"/>	<input type="checkbox"/>	0	
65	16#2320:16#01	EnablePackets	1	8	<input type="checkbox"/>	<input type="checkbox"/>	0	
66	16#2320:16#02	Data to Pluto timeout	0	16	<input type="checkbox"/>	<input type="checkbox"/>	0	
67	16#2320:16#03	Data to Pluto update time	100	8	<input type="checkbox"/>	<input type="checkbox"/>	0	
68	16#2321:16#00	Gateway Node Address	4	8	<input type="checkbox"/>	<input type="checkbox"/>	0	

Figure 51 – EtherCAT, include configuration of all additional data.

Please note that the “EnablePackets” startup parameter value has been set to 1, only enabling packet 0. To enable all four available packets this must be set to 15. See bullet 12.4 for a description of line 65, 66 and 67.

Edit the settings of an object as required. The example project below show how the gateway’s node number on the Pluto bus is set to 4 e.g. selecting node address 3, see 6.1.4.1.

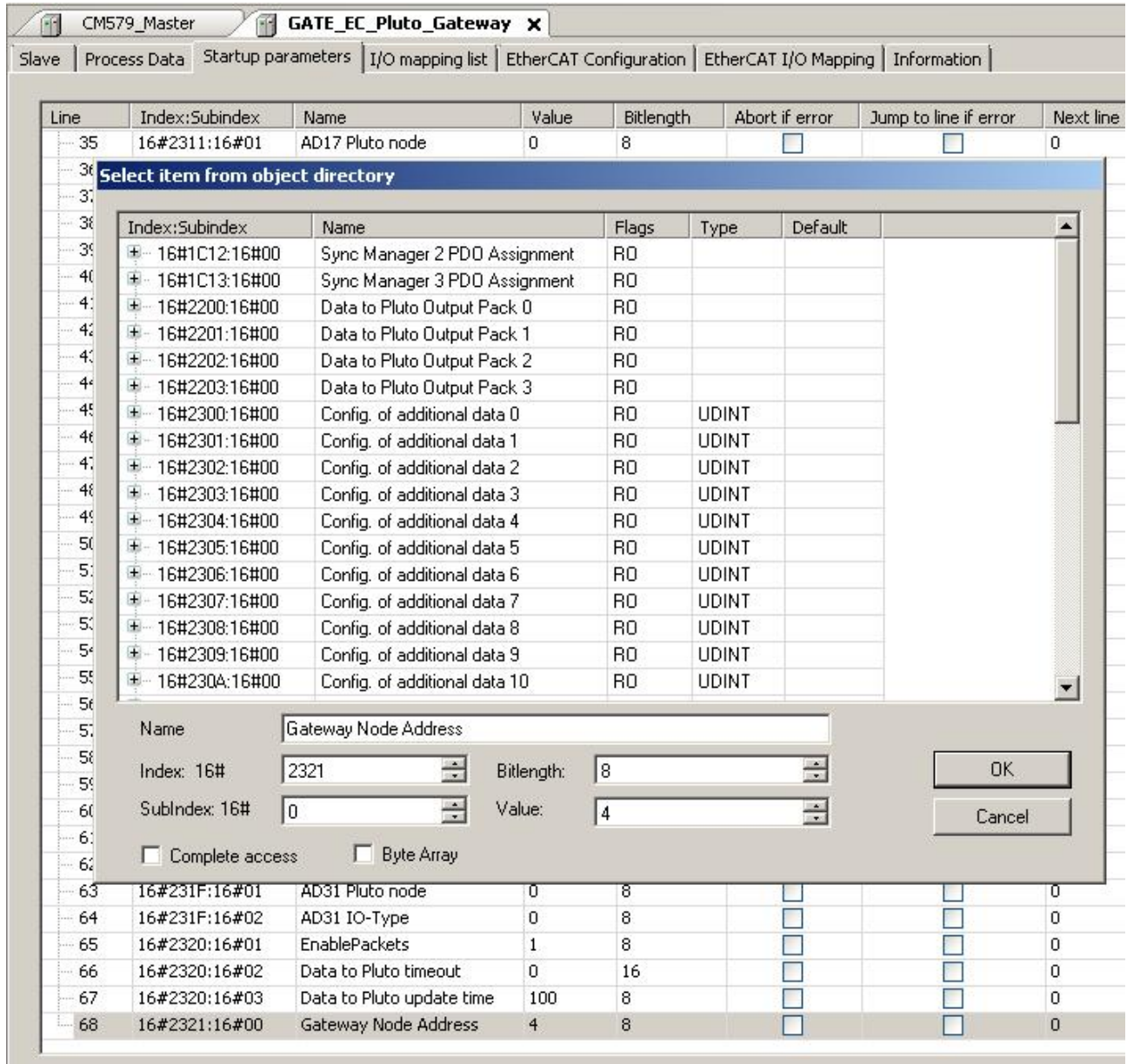

Figure 52 – EtherCAT, change setting.

8.4.6 I/O mapping list

Enter the names of the variables that will be used in the CoDeSys environment.

Object Name	Variable	Channel	Address	Type	Description
GATE_EC_Pluto_Gateway	P0_Bits_0_15	Bit Variables	%QW1.0	UINT	Bit Variables
GATE_EC_Pluto_Gateway	P0_Reg_0	Register 0	%QW1.1	UINT	Register 0
GATE_EC_Pluto_Gateway	P0_Reg_1	Register 1	%QW1.2	UINT	Register 1
GATE_EC_Pluto_Gateway		Bit Variables	%QW1.3	UINT	Bit Variables
GATE_EC_Pluto_Gateway		Register 0	%QW1.4	UINT	Register 0
GATE_EC_Pluto_Gateway		Register 1	%QW1.5	UINT	Register 1
GATE_EC_Pluto_Gateway		Bit Variables	%QW1.6	UINT	Bit Variables
GATE_EC_Pluto_Gateway		Register 0	%QW1.7	UINT	Register 0
GATE_EC_Pluto_Gateway		Register 1	%QW1.8	UINT	Register 1
GATE_EC_Pluto_Gateway		Bit Variables	%QW1.9	UINT	Bit Variables
GATE_EC_Pluto_Gateway		Register 0	%QW1.10	UINT	Register 0
GATE_EC_Pluto_Gateway		Register 1	%QW1.11	UINT	Register 1
GATE_EC_Pluto_Gateway		Pluto status	%ID1.0	UDINT	Pluto status
GATE_EC_Pluto_Gateway		Pluto 0	%ID1.1	UDINT	Pluto 0
GATE_EC_Pluto_Gateway	P1_Global	Pluto 1	%ID1.2	UDINT	Pluto 1
GATE_EC_Pluto_Gateway		Pluto 2	%ID1.3	UDINT	Pluto 2
GATE_EC_Pluto_Gateway		Pluto 29	%ID1.30	UDINT	Pluto 29
GATE_EC_Pluto_Gateway		Pluto 30	%ID1.31	UDINT	Pluto 30
GATE_EC_Pluto_Gateway		Pluto 31	%ID1.32	UDINT	Pluto 31
GATE_EC_Pluto_Gateway	P4_ErrorCode	Additional area 0	%ID1.33	UDINT	Additional area 0
GATE_EC_Pluto_Gateway	P4_ToGW_Usr1	Additional area 1	%ID1.34	UDINT	Additional area 1
GATE_EC_Pluto_Gateway		Additional area 2	%ID1.35	UDINT	Additional area 2
GATE_EC_Pluto_Gateway		Additional area 3	%ID1.36	UDINT	Additional area 3
GATE_EC_Pluto_Gateway		Additional area 4	%ID1.37	UDINT	Additional area 4

Figure 53 – EtherCAT, add names for the variables.

Result as shown in the CoDeSys environment programming tool.

0001	VAR_GLOBAL
0002	P0_Bits_0_15 AT %QW1.0 : UINT; (* Bit Variables *)
0003	P0_Reg_0 AT %QW1.1 : UINT; (* Register 0 *)
0004	P0_Reg_1 AT %QW1.2 : UINT; (* Register 1 *)
0005	P1_Global AT %ID1.2 : UDINT; (* Pluto 1 *)
0006	P4_ErrorCode AT %ID1.33 : UDINT; (* Additional area 0 *)
0007	P4_ToGW_Usr1 AT %ID1.34 : UDINT; (* Additional area 1 *)
0008	END_VAR

Figure 54 – EtherCAT, variable names in CoDeSys.

8.5 Beckhoff TwinCAT integration

This chapter will describe how to use the gateway GATE-EC with Beckhoff TwinCAT system.

8.5.1 Add device description file

The description file for EtherCAT is called ESI XML files. For the gateway GATE-EC this file is named "ABB_JokabSafety_GATE-EC.xml". Installation is easily done by copying the file into the correct TwinCAT directory.

For TwinCAT 2 copy the file into "TwinCAT\Io\EtherCAT" directory.

After the installation of the file you need to restart system manager so it will reread the configuration directory for new information.

8.5.2 Scan system for the device

The unit will be easily installed into a system by scanning the system for boxes. During this scan it will detect the gateway GATE-EC and generate a box for it where all settings and data then will be available, see picture below.

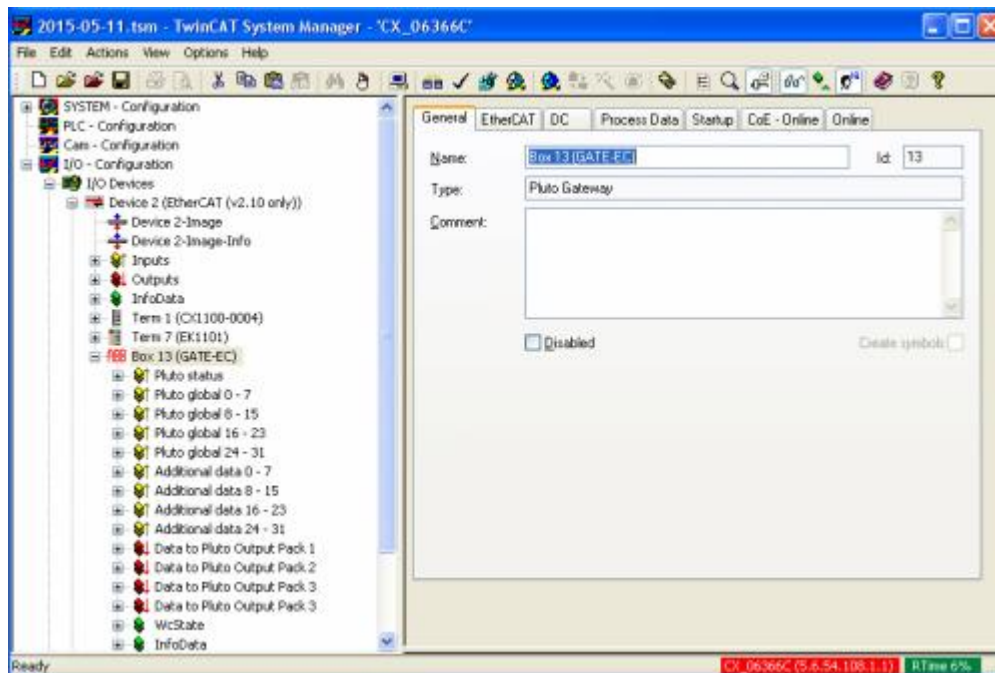

Figure 55 – EtherCAT, result of scanning the system with GATE-EC.

8.5.3 Firmware update

With system supporting FoE (File access over EtherCAT) it's possible to update the device firmware in the gateway GATE-EC. In a Beckhoff TwinCAT system the file download button can be found in the "Online" tab of the device,

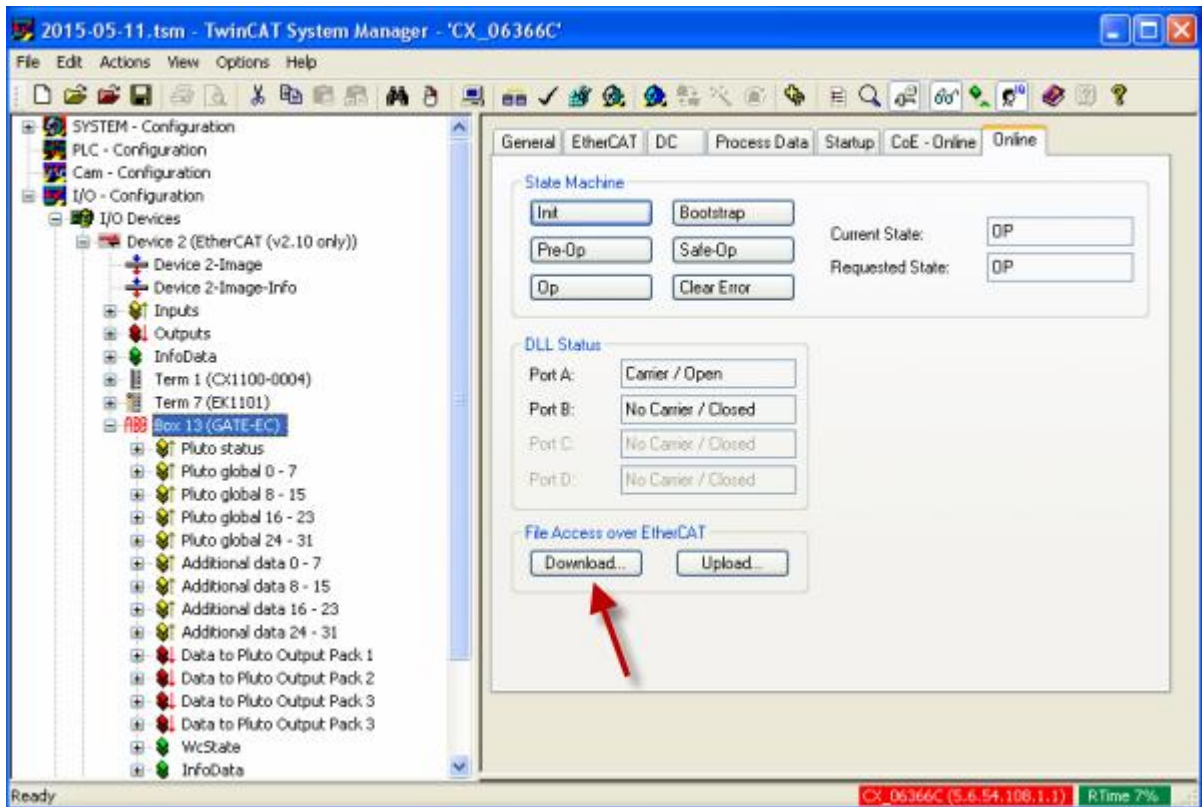

Figure 56 – EtherCAT, firmware update using the FoE, press “Download...”.

When pressing the “Download...” button the first steps will be to select the firmware file which shall be sent to the device. To be able to see the file you need first to change so you can see all files (1) and then navigate to the file which shall be named “GATE-EC_yyyy-mm-dd_vx.y.NXF” (2) and then click open.

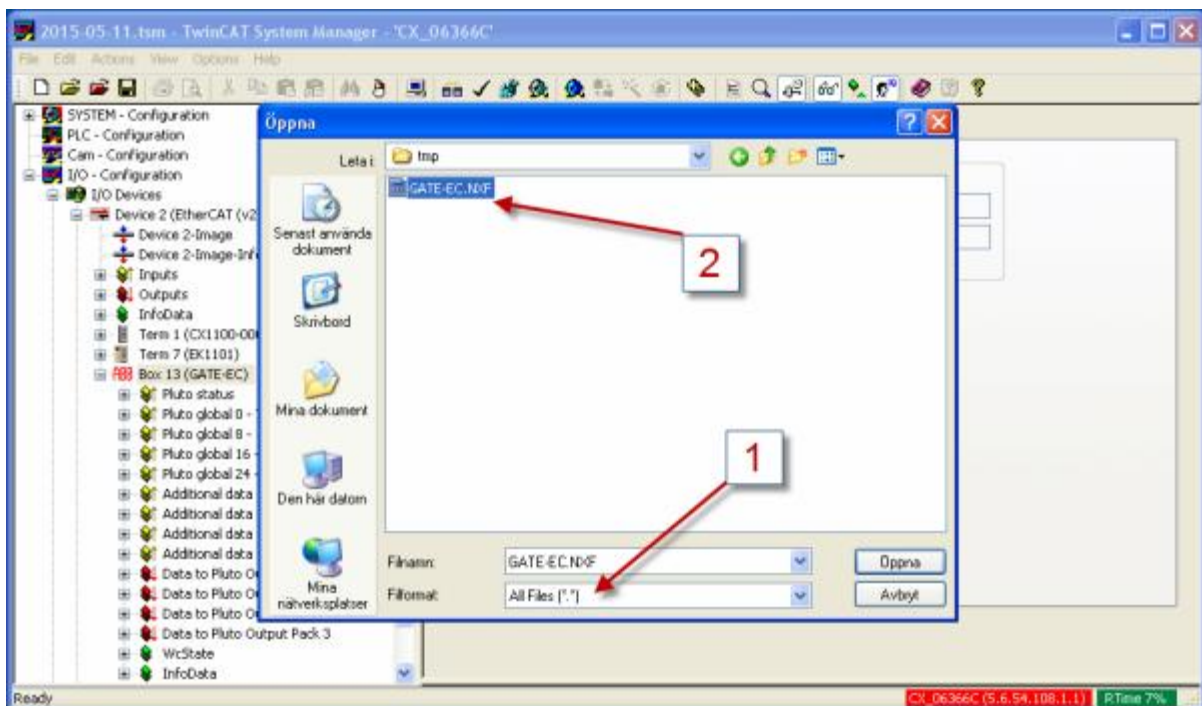

Figure 57 – EtherCAT, select the firmware file named “GATE-EC”.

You will now get a dialog for the FoE file name transfer similar to this one,

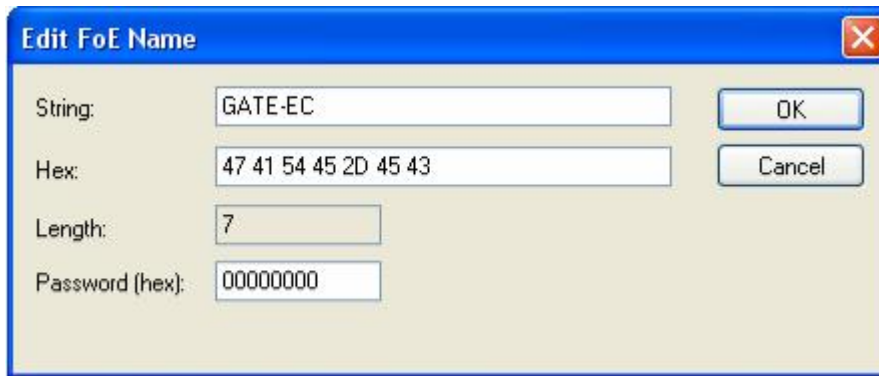

Figure 58 – EtherCAT, default FoE transfer window.

In this dialog you need to write string as “GATE-EC.NXF” so the dialog will look like below,

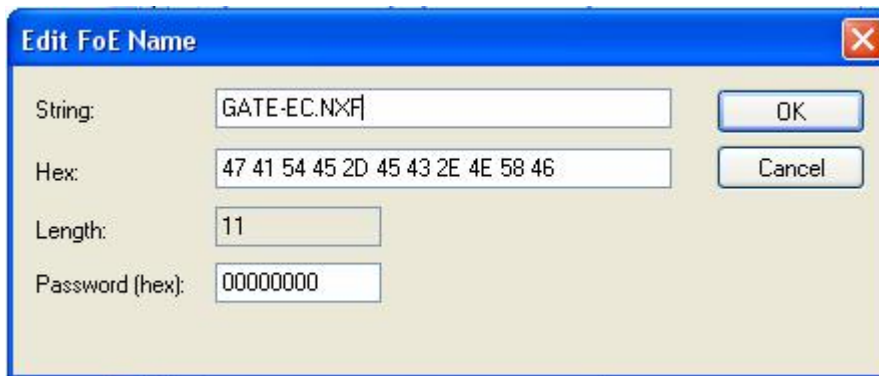

Figure 59 – EtherCAT, edit the FoE transfer window.

Click OK button and the file transfer will start and you will see a download progress bar in the TwinCAT window,

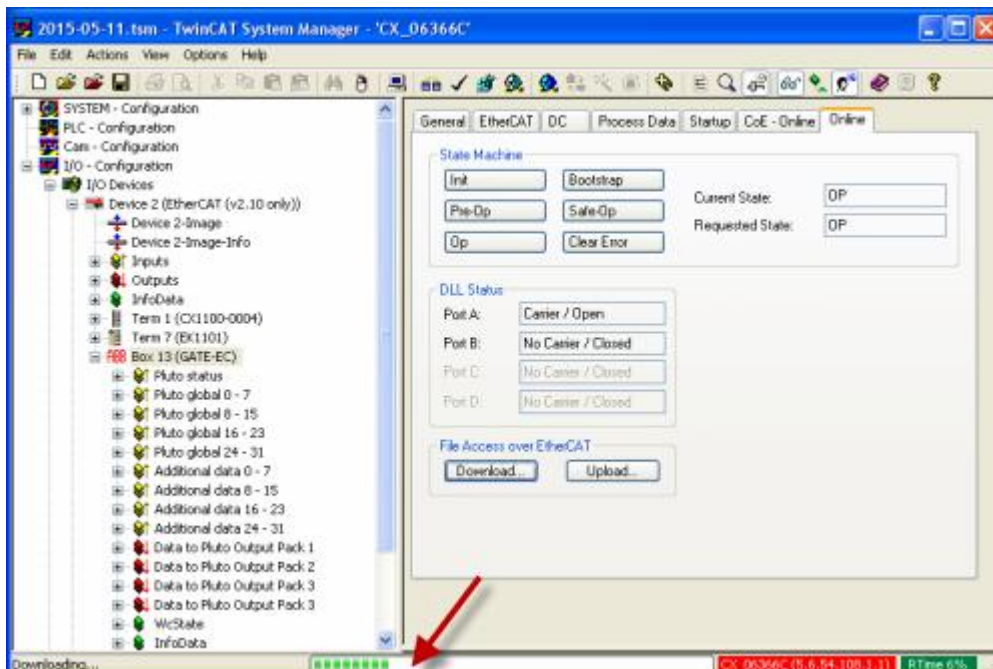

Figure 60 – EtherCAT, FoE download progress bar.

When the download is finished the gateway unit need to be restarted to start running the downloaded application.

9 GATE-S3, Sercos III

The Ethernet gateway GATE-S3 is an Ethernet gateway handling the industry Ethernet protocol Sercos III according to,

- Communication Spec. V1.1.2.1.7 (March 30, 2009).
- Sercos Communication Profile V1.1.2.1.1 (March 31, 2009).
- Function Specific Profile IO V1.1.2.1.4 (May 11, 2009).
- Internet Protocol Services V1.3.1 - 1.2 (February 10, 2011).
- Minimum cycle time is 500 μ s.

9.1 Ethernet Connection

The gateway is connected to Sercos III network using standard Ethernet connector and cable according to chapter 0 and 5.1.3.2. As Sercos III is a bus where each device has an input and output side the “Eth 1” port is the input port and “Eth 2” is the output port, see figure below.

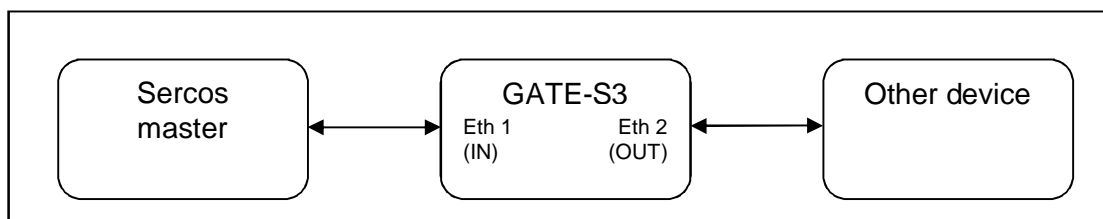

Figure 61 – Sercos, network connection via the gateway device.

9.2 IP address configuration

The IP address assignment for the unit is by default set to 192.168.0.100. It can be changed via the terminal port. For Sercos III the last not connected port in the chain can be used for normal Ethernet connections and this is valid for the GATE-S3 also. So if the “Eth 2” port is not used for Sercos III connection to other Sercos device this port is free for normal TCP/IP access on the Sercos system. This is done by connecting a computer with correct IP address settings, and then it's possible to access the gateways remote server (if enabled) this way.

9.3 Status indication

On the gateway with Sercos III there are one dual colors LED for Sercos III status indication, named S3. Currently this is not a true dual color LED as stated in the Sercos specification but it has the same behavior. The tables below explain the indicators status information, when both the green and red light the color shall be orange.

Pattern	Color	Description	Priority	Comment
1		NRT-Mode	0	No SERCOS communication
2	██████████	CP0	0	Communication phase 0 is active
3	██████████	CP1	0	Communication phase 1 is active
4	██████████	CP2	0	Communication phase 2 is active
5	██████████	CP3	0	Communication phase 3 is active
6	██████████	CP4	0	Communication phase 4 is active
7	██████████	HP0	1	Device is in hot-plug phase 0
8	██████████	HP1	1	Device is in hot-plug phase 1
9	██████████	HP2	1	Device is in hot-plug phase 2
10	██████████	Fast forward ⇒ Loopback	2	RT-state has changed from fast-forward to loopback
11	██████████	Application error	3	See GDP & FSP Status codes class error
12	██████████	MST losses ≥ (S-0-1003/2)	4	As long as the communication warning (S-DEV.Bit15) in the Device Status is present, at least 2 sec.
13	██████████	Communication error	5	See SCP Status codes class error
14	██████████	Identification	6	Invoked by (C-DEV.Bit 15 in the Device Control) or SIP Identification request
15	██████████	Watchdog error	7	Application is not running
3 seconds, each flash 250 ms.				

Table 23, Sercos, status indication behavior.

9.4 Service port information

The Sercos III service is using several network ports on the device.

Port		Description
UDP	35021	Encapsulation messages based on UDP.

Table 24, Sercos, service port information.

9.5 Bosch-Rexroth IndraWorks integration

This chapter will highlight some aspects on integrating gateway GATE-S3 with a Bosch-Rexroth IndraWorks system.

9.5.1 Add device description file

Select in IndraWorks menu “Tools” and “Device Database...” which will bring up this window,

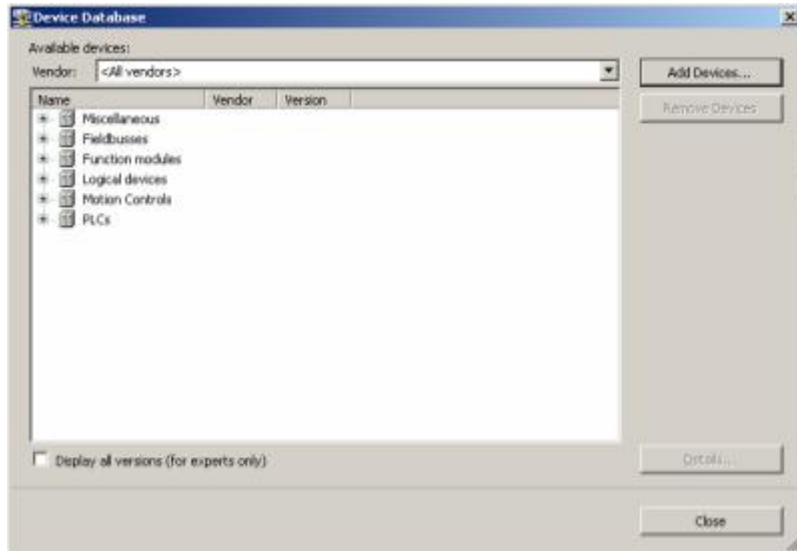

Figure 62 – Sercos, add the description file.

Press the “Add Devices...” button and select the description file for the gateway GATE-S3 device which is named something like

”SDDML#3.0#ABB_AB_JOKAB_SAFETY#ABB_GATE-S3#2015-03-25.xml”.

If a correct installation you can see the device in the “Device database” under the directory “Fieldbusses” – “Sercos3” – “Slave” – “ABB GATE-S3”, see picture below.

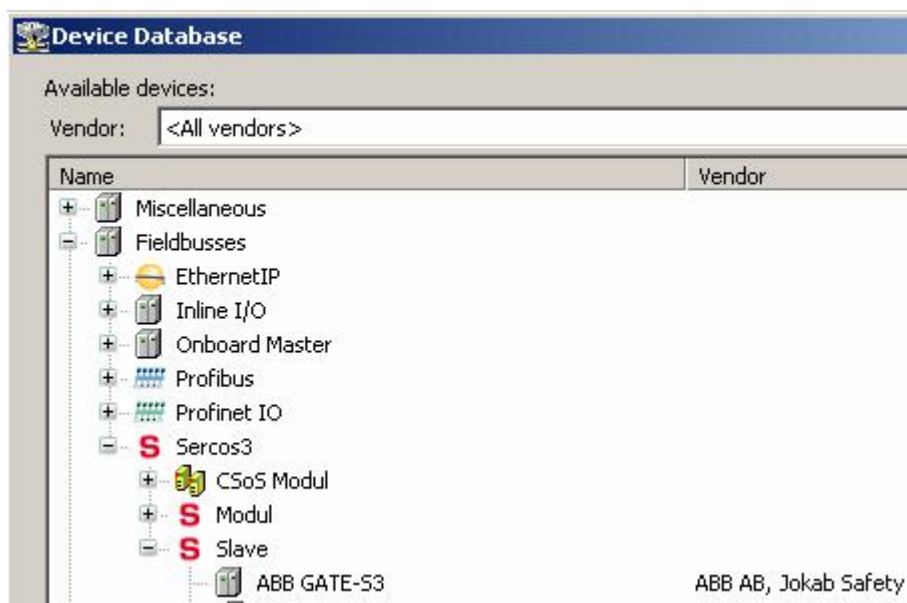

Figure 63 – Sercos, view the installed description file as “ABB GATE-S3”.

9.5.2 Scan system for the device

The unit will be easily installed into a system by scanning the Sercos bus by right click on the Sercos bus in the project and select “Scan Bus Configuration”. During this scan it will detect the gateway GATE-S3 and add it to the project via the “Scan Bus Configuration” windows which will follow the scan of the bus.

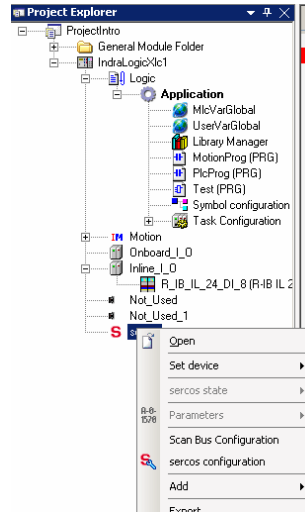

Figure 64 – Sercos, scan the bus with “Scan Bus Configuration”.

After adding the device the project explorer will view the gateway in a way similar to the example below,

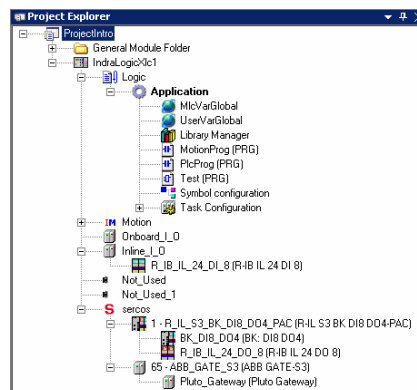

Figure 65 – Sercos, example of the project after adding the gateway.

9.5.3 Gateway configuration

By clicking on the two gateway modules in the project explorer it's now possible to configure the gateway device as needed. For example the startup configuration can be updated via "User Parameter" tab.

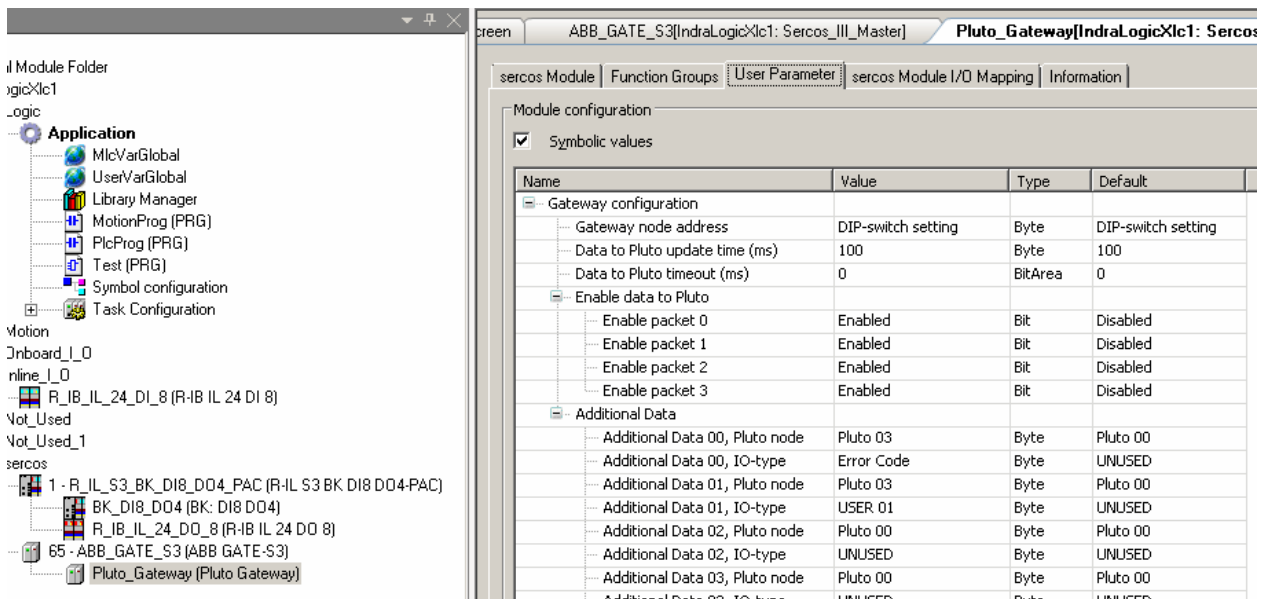

Figure 66 – Sercos, change gateway configuration.

10 GATE-PN, PROFINET

The Ethernet gateway GATE-PN is an Ethernet gateway handling the industry Ethernet protocol PROFINET which is defined by PI Organization. It is build according to,

- Specification for PROFINET, Version 2.31.
- IRT Top (“Red phase”) will be supported.
- Minimum cycle time 2ms for RTC1 and 1ms for RTC3.

Note: Limitation

Minimum cycle time of 1 and 2 ms are today only possible when the Pluto system has maximum 8 Pluto units. For cycle time below 10 ms the limits are maximum 16 Pluto units. From 10 ms and up, a full Pluto system can be used.

10.1 Description file

The description file (GSSML) is the description file which shall be imported into the master PLC configuration tool.

The description file has two access points,

- GATE-E2 (Compatibility Mode).
This access point shall only be used as a backward compatibility access point when making direct replacement of GATE-E2 device.

Shall not be used for new system configuration!

- GATE-PN.
This is the access point which shall be used in new system configurations.

For more information see PROFINET description appendix at chapter 18.

10.2 Data format

Pluto data in chapter 12 (Pluto global data 12.2, Pluto additional data 12.3 and data to Pluto 12.4) is in little endian format but data received/transmitted via PROFINET will in the master PLC be in big endian format. The table below show how this effects how data is arranged in the master PLC memory.

Unsigned32			
PLC memory	Weight	Pluto global byte order see 12.2	Additional byte order see 12.3
0	MSB	3	3
1		2	2
2		1	1
3	LSB	0	0

Unsigned16	
PLC memory	Weight
0	MSB
1	LSB

Table 25, PROFINET, data format.

10.3 Ethernet Connection

The gateway is connected to PROFINET network using standard Ethernet connector and cable according to chapter 0 and 5.1.3.2. Both Ethernet ports have the same functionality and can be connected as desired. Normally Ethernet port 1 shall be used to connect to a network switch and Ethernet port 2 can be used to connect to other Ethernet device on the network if desired.

Each port can handle connection in both 10 and 100 Mbit/s using half or full duplex. The port automatically configures the port so it can be connected without using any special cross connected cabled.

The gateway has two Ethernet ports, and therefore it's possible to connect another device on the same Ethernet switch output by connection the other device to the second Ethernet port on the gateway. This will however increase the network traffic and may decrease the performance of the gateway device.

The gateway can be installed in a PROFINET IRT network even that the gateway itself doesn't have any real time data update performance.

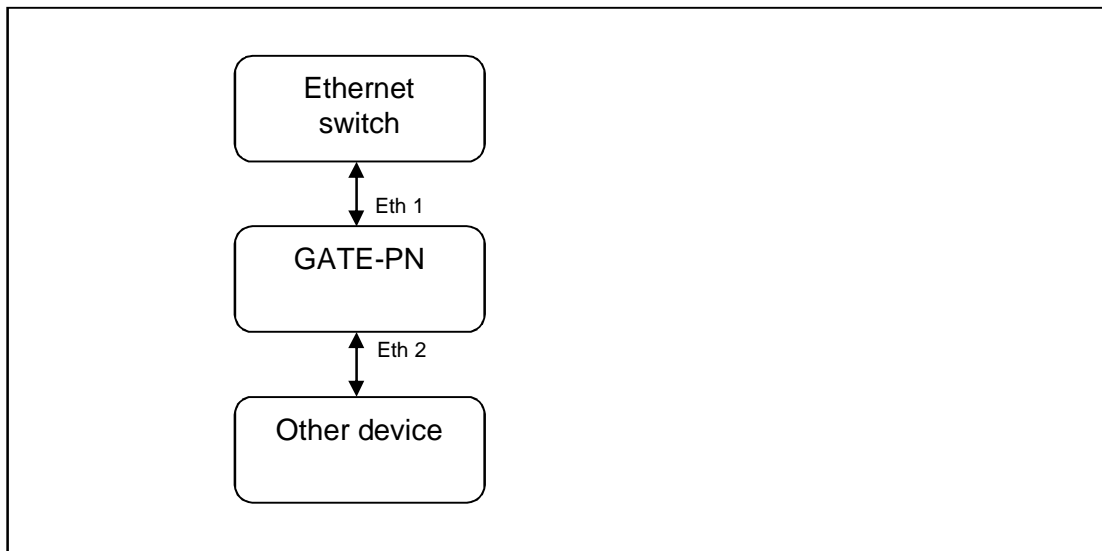

Figure 67 – PROFINET, network connection via the gateway device.

10.4 IP address configuration

The IP address assignment for the unit is managed by the PROFINET master and can't be changed in any other way.

Instead of the IP address the device station name must be assigned using any DCP handling program within the master PLC configuration tool or similar standalone program. When the device has a device station name the master PLC will configure and assigned IP address according to the master configuration data.

10.5 Status indication

On the gateway with PROFINET there are two dual color LEDs for PROFINET status indications. They are named SF (System Failure) and BF (Bus Failure). The tables below explain the indicators status information.

10.5.1 SF (System Failure)



LED		PROFINET	Remark
OFF		No system error.	
RED steady		Red steady on when diagnostic error.	Currently the device doesn't have any diagnostic handling.
GREEN flashing		Device identification via the "blink" command from master device.	Flashing is 1 Hz for minimum 3 seconds.

Table 26, PROFINET, SF status indication behavior.

10.5.2 BF (Bus Failure)



LED		PROFINET	Remark
OFF		No bus error.	
RED flashing		Ethernet cable connected but not connection.	
RED steady		No Ethernet cable connection on any port.	

Table 27, PROFINET, BF status indication behavior.

10.6 Service port information

The PROFINET service is using several network ports on the device.

Port	Description	
UDP	161	SNMP is mandatory for PROFINET.
	34964	PROFINet RPC Endpointmapper Port.
	49152	PROFINet RPC Device Server.

Table 28, PROFINET, service port information.

10.7 ABB AC500 implementation

This example shows a simple implementation of the Gate-PN in an ABB AC500 PLC, using a CM579-PNIO communication module. It doesn't show any actual program, just how the "to" and "from" variables via the gateway Gate-PN are setup. Automation Builder V1.1.1717 was used.

10.7.1 Device repository and XML file

In Automation Builder under the Tools menu, start the "Device Repository" tool.

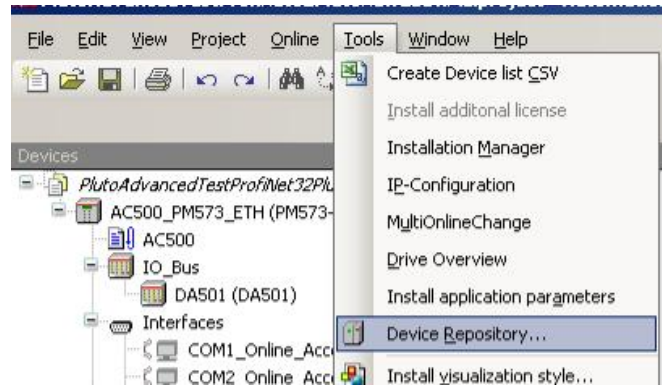

Figure 68 – PROFINET, add description file to "Device Repository...".

Use the "Install..." button and point at the file's location. Please note that it is included in Pluto Manager, under the Help menu. The result is shown in the picture below.

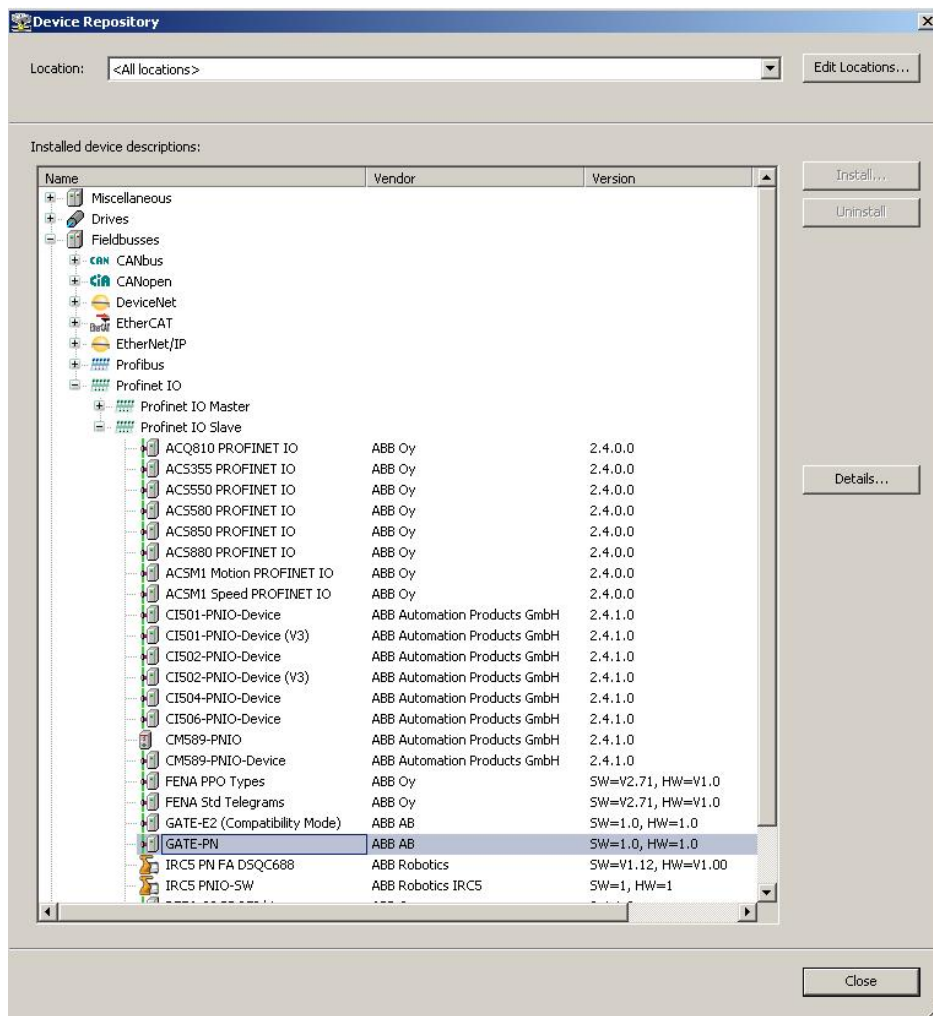

Figure 69 – PROFINET, view the installed device as "GATE-PN".

10.7.2 Hardware

After adding the CM579-PNIO communication module right-click and add the Gate-PN object.

10.7.2.1 Adding objects

Add objects by right-clicking. Please note that each object under the Gate-PN has a specific place in the structure. “Node_Status” below must always be in the first location, “Pluto_Nodes_00_07” in the second, “Pluto_Nodes_08_15 in the third”, and so on.

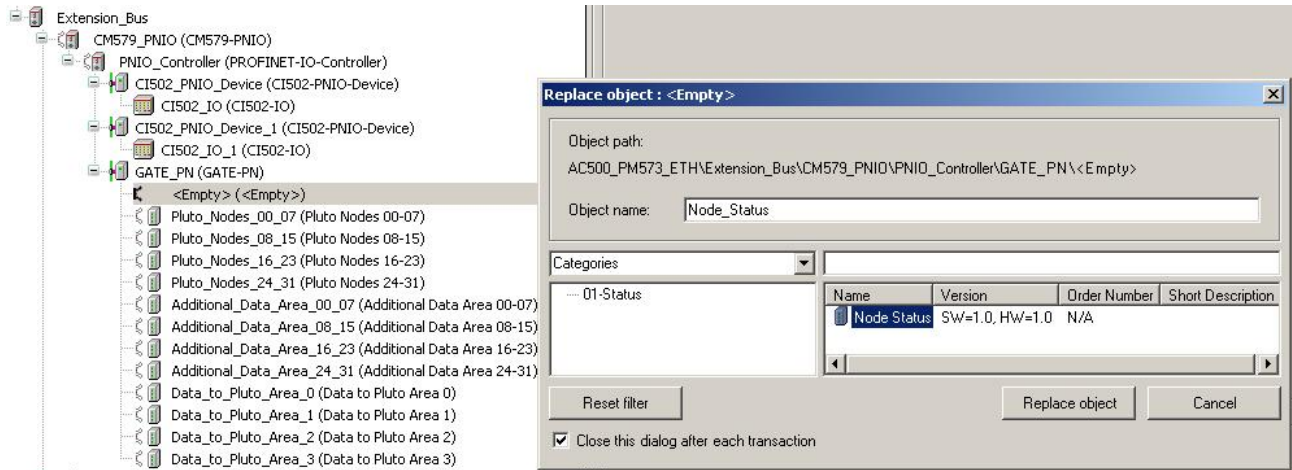

Figure 70 – PROFINET, adding modules.

The result when all object has been added. Please note that you may need to configure some objects further.

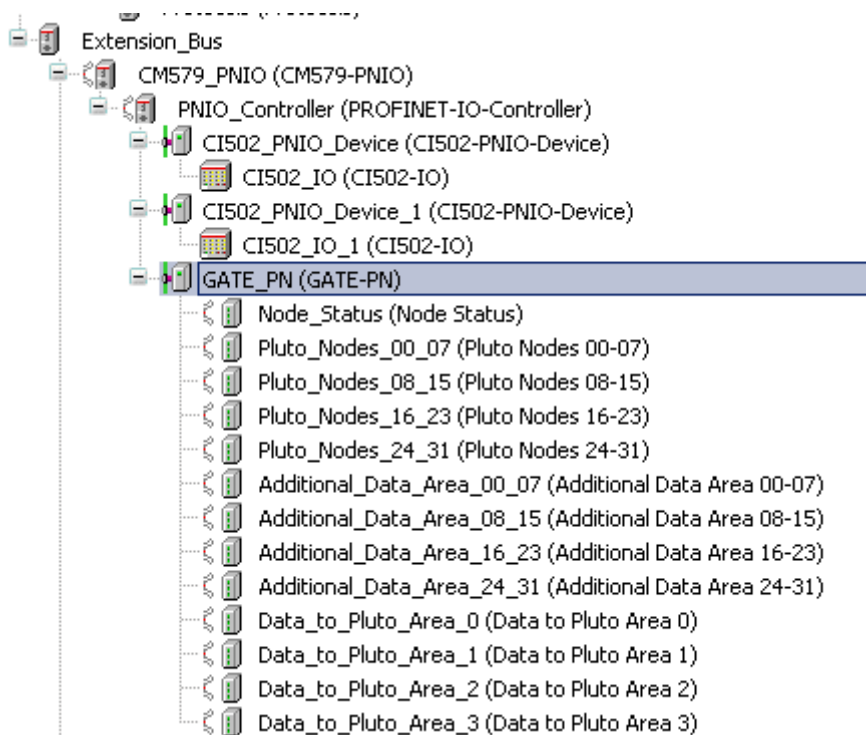

Figure 71 – PROFINET, example adding all modules.

10.7.2.2 Configuring objects

In the picture below it is shown how each Additional Data area is configured. Each area, 0 to 31, must be configured so that it knows which Pluto unit it should expect data from and what type it should be. See chapter 12.3.

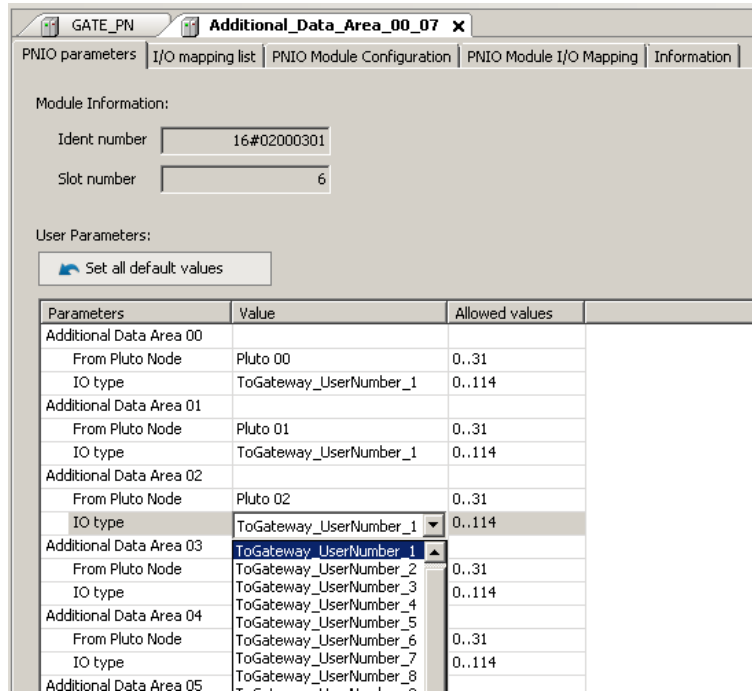

Figure 72 – PROFINET, example configuration of a module (additional data).

10.7.2.3 Configuring Gate-PN

The Gate-PN in the picture has been configured for a request interval of 16 ms. You can also set its node number (address) on the Pluto bus here, instead of using the DIP switches on the gateway. See bullet 12.4.

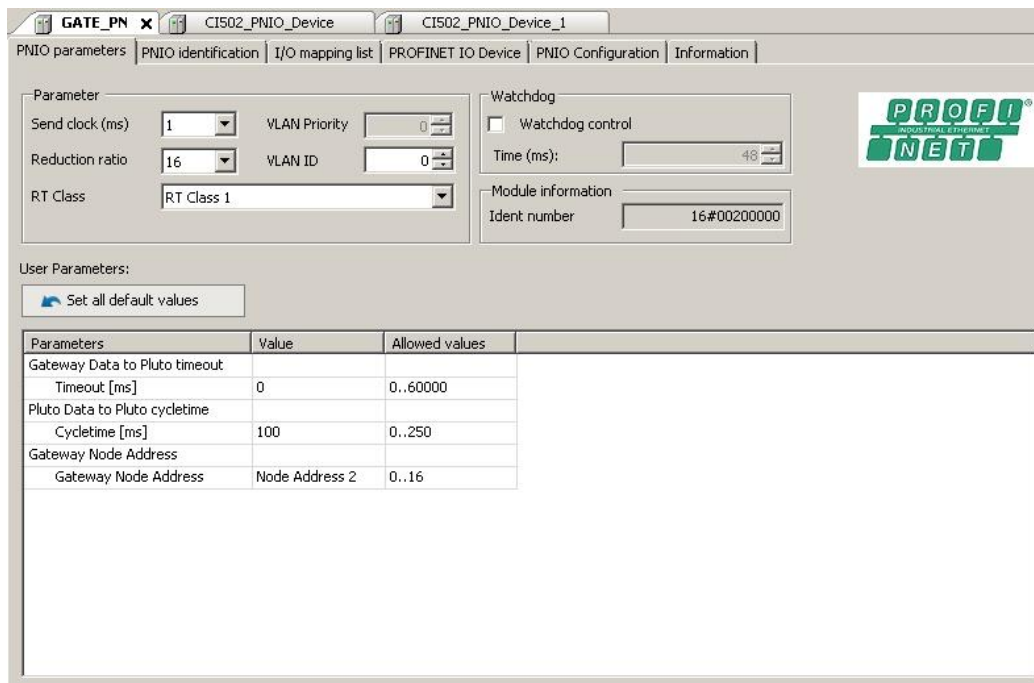

Figure 73 – PROFINET, example of the device configuration.

10.7.3 PROFINET name

Either use Pluto Manager, Tools menu, Terminal Window (NAME command), and a programming cable connected to the gateway, or use the tool under the CM579-PNIO communication module to assign a PROFINET name to the gateway. This will establish communication with the gateway.

The screenshot shows the 'PNIO_Controller' software interface. At the top, there are tabs for 'Diagnostics for Profinet', 'PROFINET IO Controller', 'PROFINET-IO-Controller Configuration', 'Assign IO-Device name', and 'I/O mapping list'. Below the tabs are buttons for 'Connect to PLC (Login)', 'Scan', and 'Disconnect from PLC'. A table lists discovered devices with columns for Device name, Device type, IP address, MAC address, Vendor Id, Device Id, Device role, Network mask, and Gateway address. Below the table is a configuration panel with the following fields and buttons:

- Configure IO-Device name: dropdown menu with 'gatepn' selected.
- Selected IO-Device type: text field with 'Pluto Gateway'.
- MAC address of selected IO-Device: text field with '00-0C-62-06-23-8D'.
- IP address: dropdown menu with '192.168.0.2' selected.
- Network mask: text field with '255.255.255.0'.
- Gateway address: text field with '192.168.0.2'.
- Parameter flag: dropdown menu with 'Assign configuration temporarily' selected.
- Buttons: 'Assign IO-Device name', 'Start LED signal', 'Assign IP configuration', and 'Factory reset'.

Figure 74 – PROFINET, setting device name.

10.7.4 Assigning variable names

Use the I/O mapping list to assign variables their names.

Object Name	Variable	Channel	Address	Type	Description	Terminal
Node_Status	NodeStatus_PN	Node Status	%ID1.1	UDINT		
Node_Status		Bit0	%IX1.4.0	BOOL		
Node_Status		Bit1	%IX1.4.1	BOOL		

Figure 75 – PROFINET, add names (assigning) for the variables.

This is how they will show up in the CoDeSys environment, ready to be used.

CoDeSys - AC500.AC500PRO - [Additional_Data_Area_00_07_Module_Mapping]

File Edit Project Insert Extras Online Window Help

Resources

- Global Variables
 - Extension_Bus
 - CM572_DP
 - CM579_PNIO
 - PNIO_Controller
 - GATE_PN
 - Additional_Data_Area_00_07_Module_Mapping <R>
 - Additional_Data_Area_08_15_Module_Mapping <R>
 - Additional_Data_Area_16_23_Module_Mapping <R>
 - Additional_Data_Area_24_31_Module_Mapping <R>
 - Data_to_Pluto_Area_0_Module_Mapping <R>
 - Data_to_Pluto_Area_1_Module_Mapping <R>
 - Data_to_Pluto_Area_2_Module_Mapping <R>
 - Data_to_Pluto_Area_3_Module_Mapping <R>
 - Node_Status_Module_Mapping <R>
 - Pluto_Nodes_00_07_Module_Mapping <R>
 - Pluto_Nodes_08_15_Module_Mapping <R>
 - Pluto_Nodes_16_23_Module_Mapping <R>
 - Pluto_Nodes_24_31_Module_Mapping <R>

```

0001 /VAR_GLOBAL
0002 AD00_PN AT %ID1.34 : UDINT;
0003 AD01_PN AT %ID1.35 : UDINT;
0004 AD02_PN AT %ID1.36 : UDINT;
0005 AD03_PN AT %ID1.37 : UDINT;
0006 AD04_PN AT %ID1.38 : UDINT;
0007 AD05_PN AT %ID1.39 : UDINT;
0008 AD06_PN AT %ID1.40 : UDINT;
0009 AD07_PN AT %ID1.41 : UDINT;
0010 END_VAR
0011
0012
0013
0014
0015
0016
0017
0018
0019
0020
0021
0022
0023
0024
    
```

Figure 76 – PROFINET, variable names in CoDeSys.

10.8 Siemens integration

This example shows a simple implementation of the Gate-PN in a Siemens S-1200 PLC, using its internal PROFINET. It doesn't show any actual program, just how the "to" and "from" variables via the gateway Gate-PN are setup. Siemens TIA portal V13 was used.

10.8.1 Install GSD XML file

Under the "Options" menu choose "Install general...".

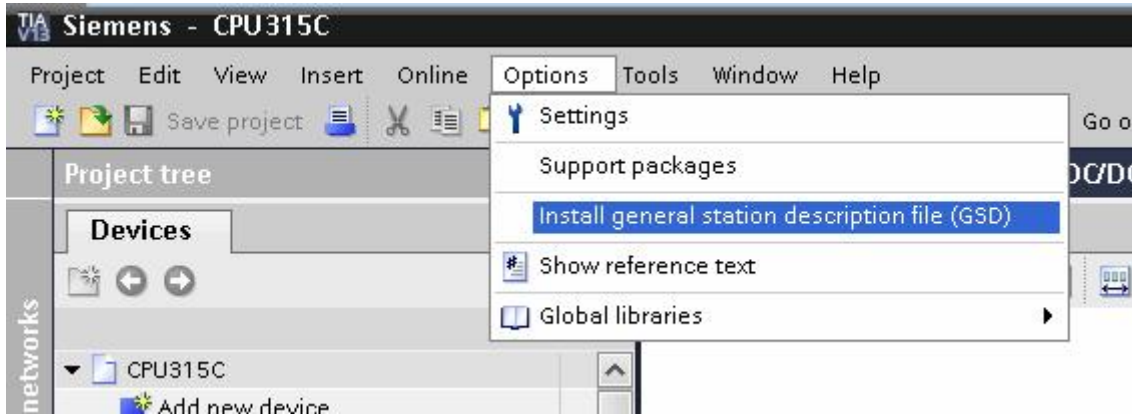

Figure 77 – PROFINET, install description file (Siemens).

Use the "Install..." button and point at the file's location. Please note that it is included in Pluto Manager, under the Help menu. The result is shown in the picture below.

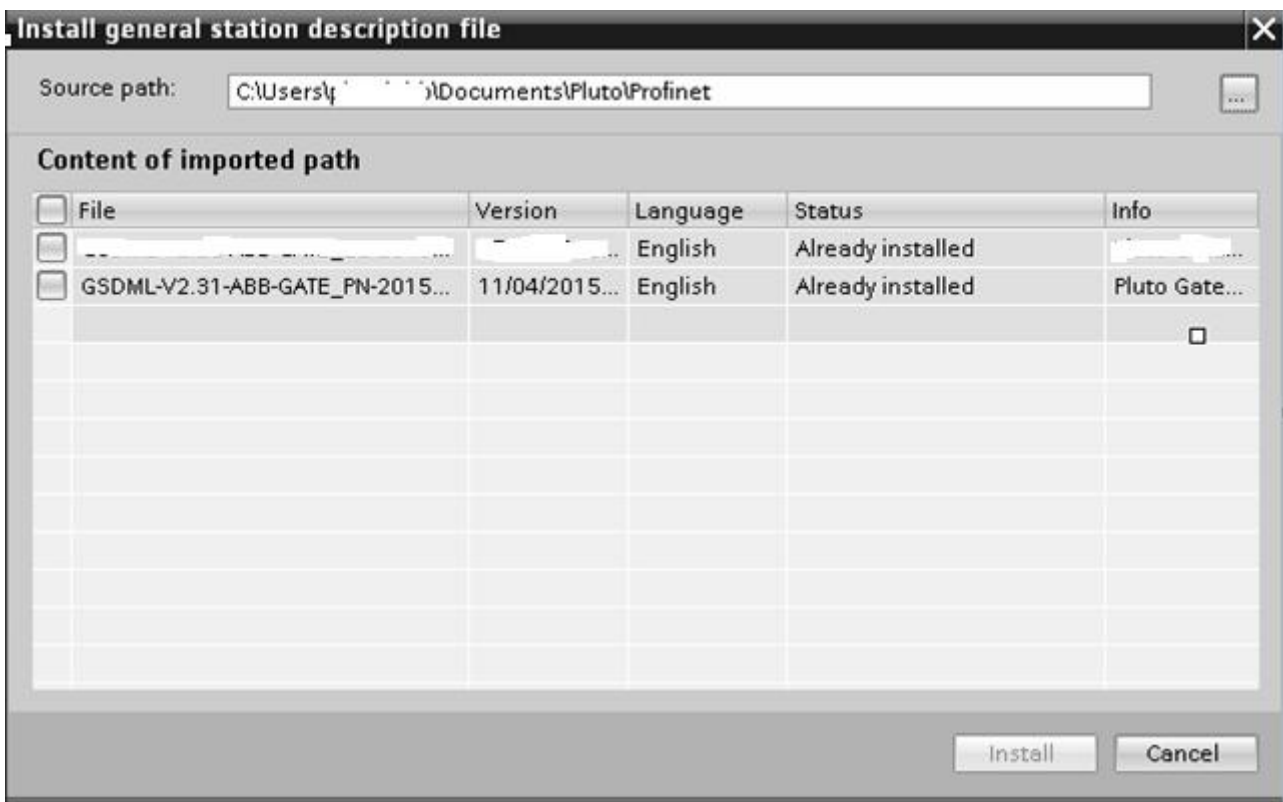

Figure 78 – PROFINET, view the result of the installation (Siemens).

10.8.2 Add the device to the PROFINET network

Use the “Devices & Networks” to add the Gate-PN. Please note that the PLC and gateway must be linked to each other with PROFINET network intended to be used.

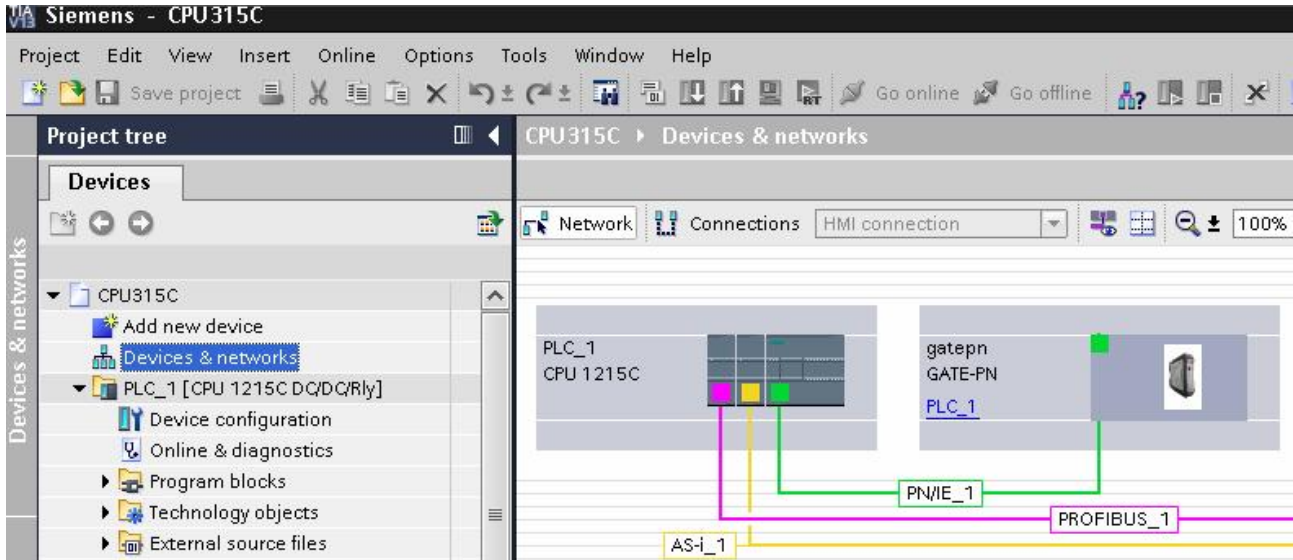

Figure 79 – PROFINET, add gateway to network (Siemens).

10.8.2.1 PROFINET name and IP address

Mark the gateway and use Properties to set its IP address. The name is default “gatepn”. This can be changed either via Pluto Manager, Tools menu, Terminal Window (NAME command), and a programming cable connected to the gateway, or use “Online access” and connect to the gateway if it’s reachable, use “Functions” to assign the name and IP address.

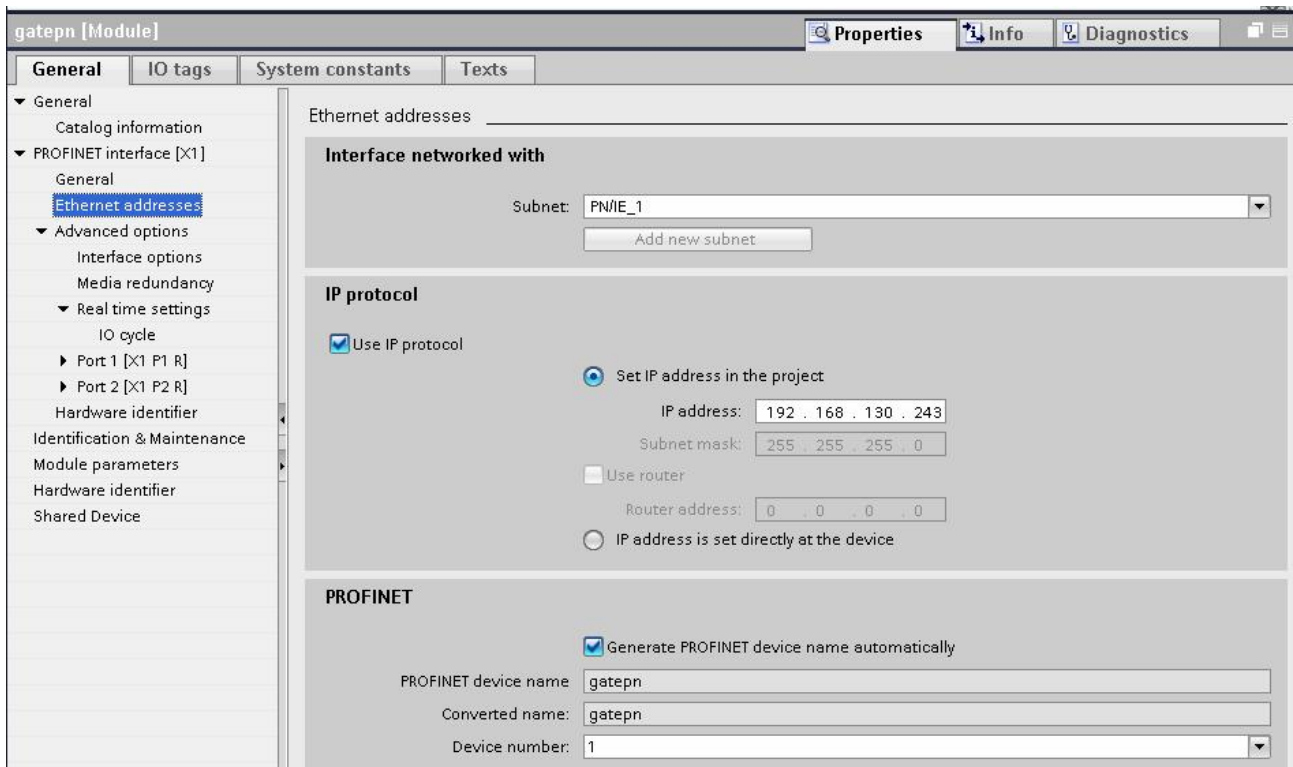

Figure 80 – PROFINET, assign name for the gateway device (Siemens).

10.8.2.2 IO Cycle

Set the gateway's IO cycle, either automatically or manually. Here it's been set manually to 16 ms.

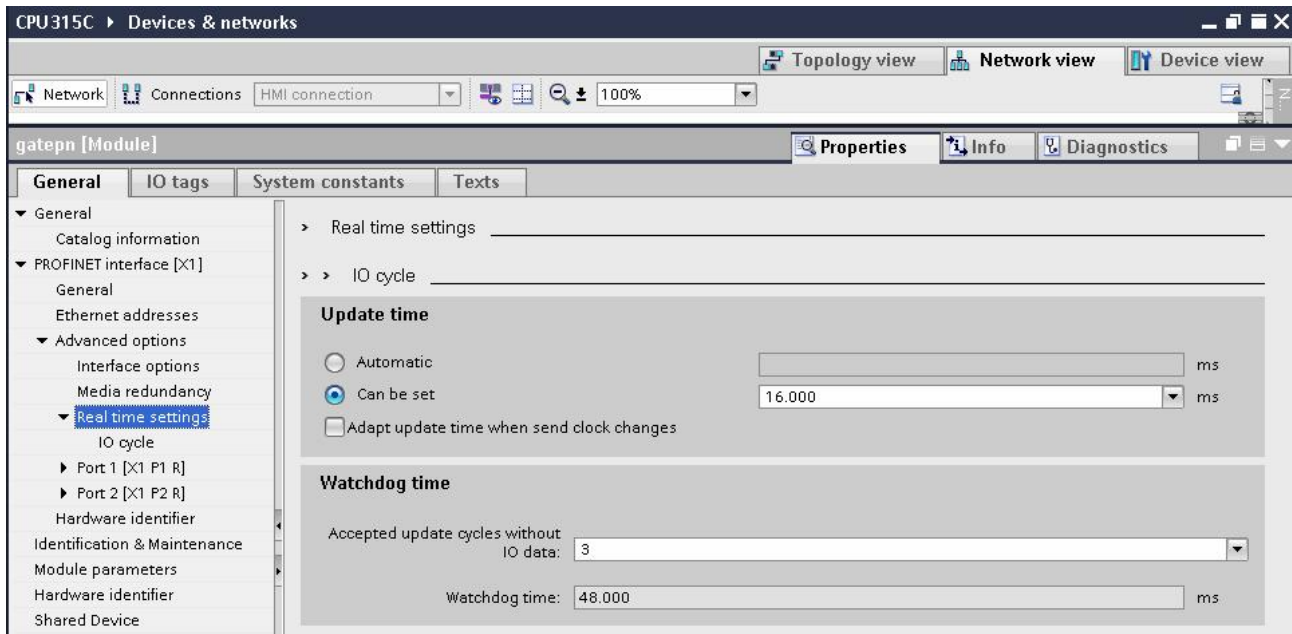

Figure 81 – PROFINET, setting IO cycle time (Siemens).

10.8.2.3 Module parameters of the Head module

Under the “Module parameters” tab settings concerning the gateways behavior on the Pluto bus is setup. See bullet 12.4.

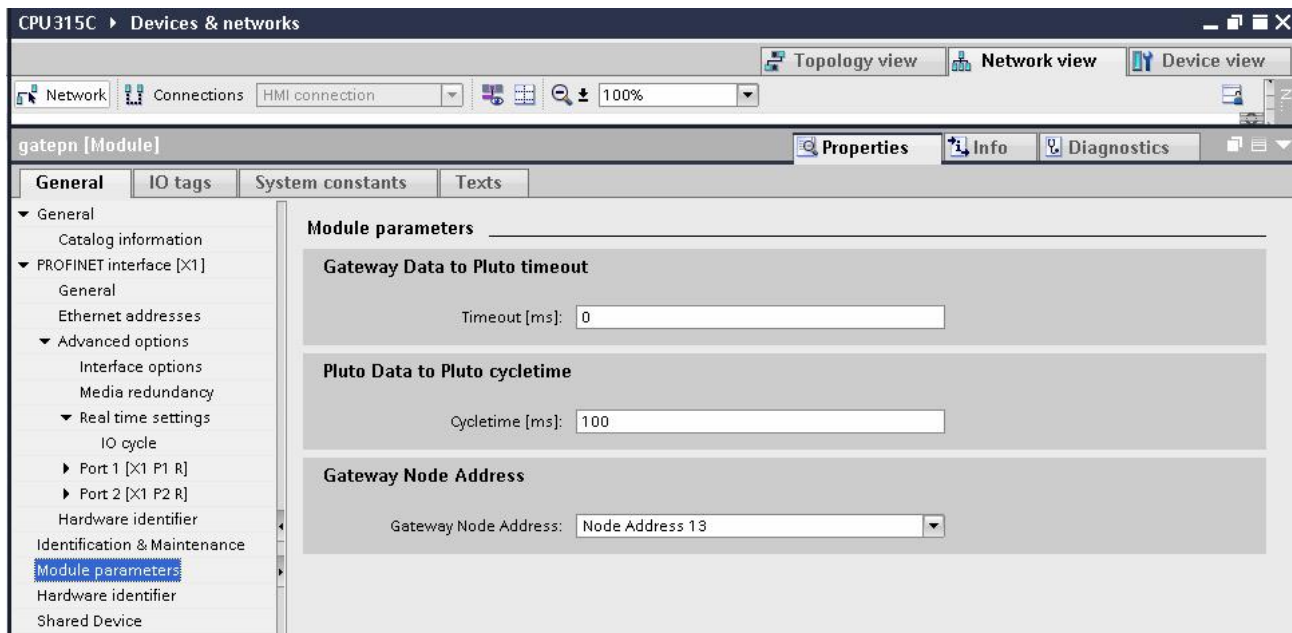

Figure 82 – PROFINET, example of the device configuration (Siemens).

10.8.2.4 Device view

Adding module is done under the “Device view”.

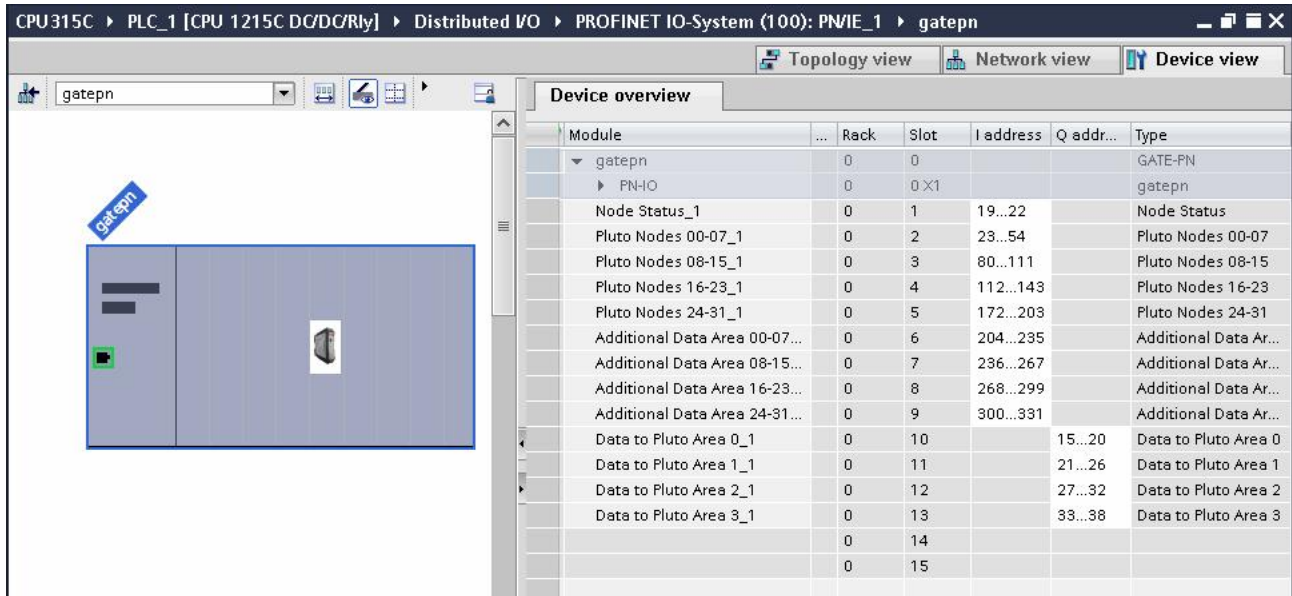

Figure 83 – PROFINET, adding module to the gateway (Siemens).

10.8.2.4.1 Adding modules under the Head module

Drag and drop the modules intended to be used from the “Hardware catalog”. Please note that each module has its intended fixed placement. “Node Status” first, “Pluto Nodes 00-07” second, and so on. As shown in the picture.

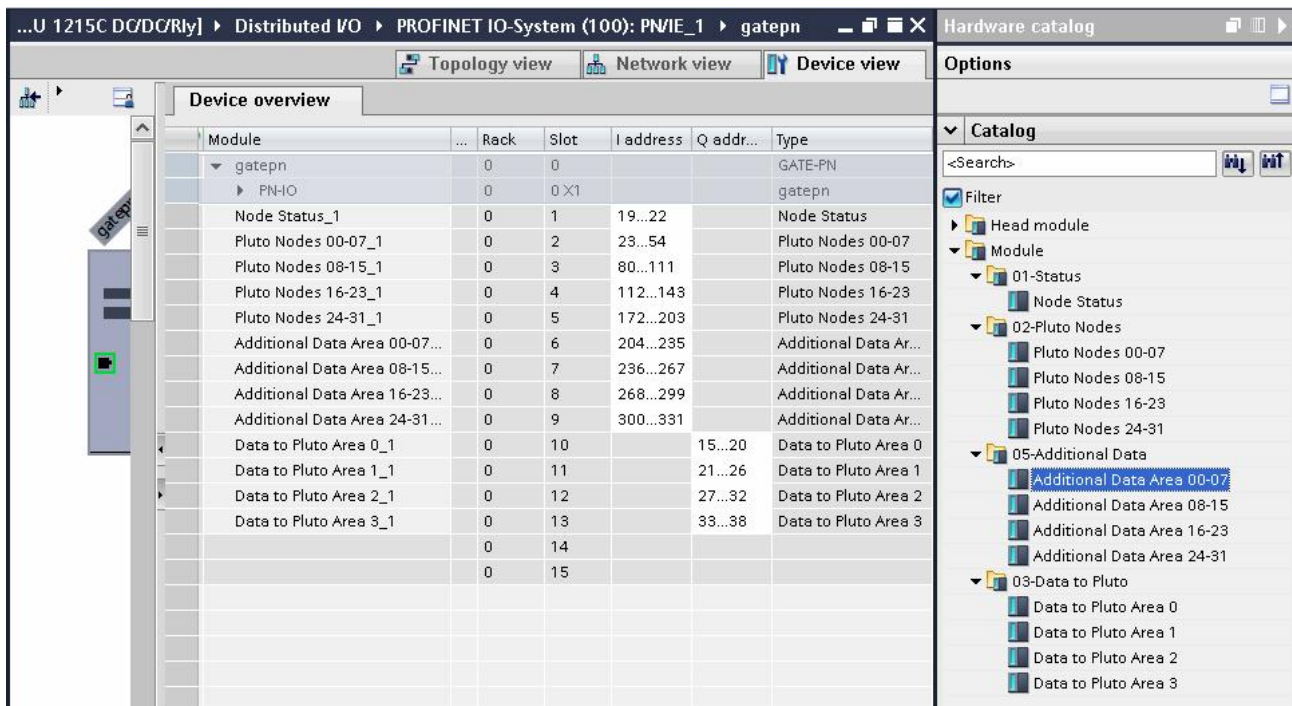

Figure 84 – PROFINET, adding module to the gateway (Siemens).

10.8.2.4.2 Module parameters of modules under the Head module

To configure module parameters such as “Additional data” parameters mark the module and use the “Module parameters” tab. Configure which Pluto node the additional data area is expecting data from and what IO type it is. See bullet 12.3.

In this example “Additional Data Area 00” is set to receive data from Pluto node 0 of the IO type 1. IO type 1 means that in the Pluto project a “ToGateway_User_X” (where X is A, B or C) is used. See bullet 12.3.2.3, network 3.

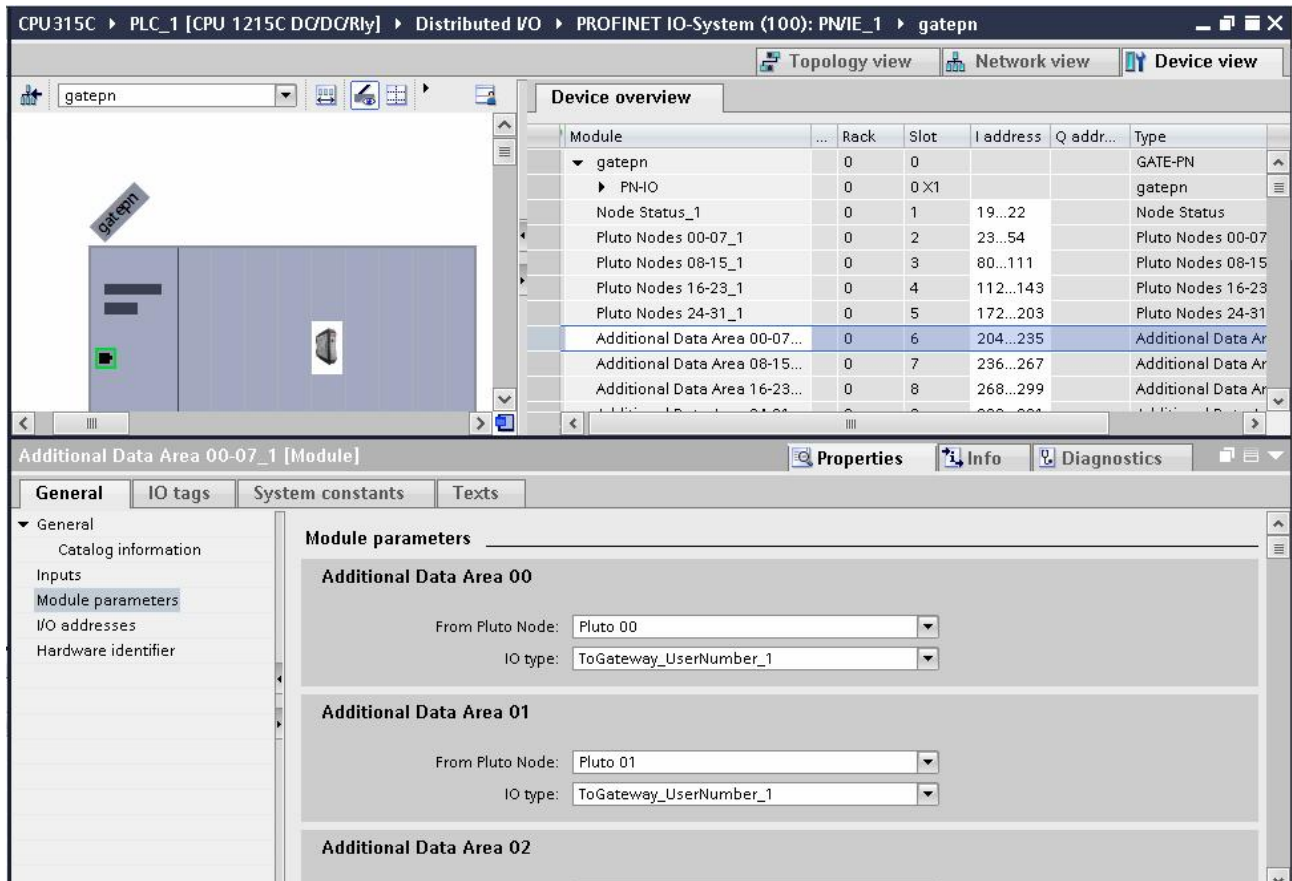

Figure 85 – PROFINET, configuration of modules (Siemens).

10.8.2.4.3 Addressing of in- and out-data

Point the modules to the intended input address or output address. In this example this has been done automatically.

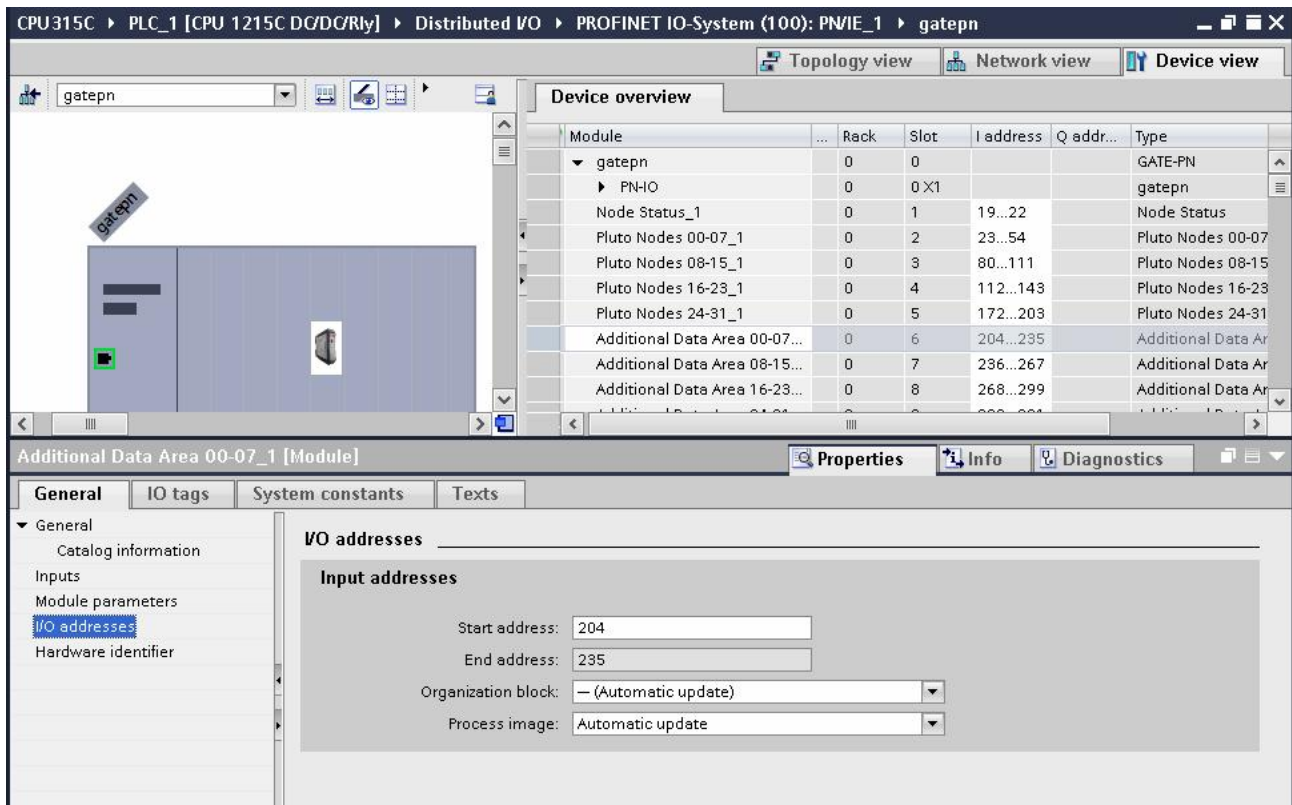

Figure 86 – PROFINET, setting input and output address (Siemens).

10.8.2.5 Tag list

Give the tags their intended name and point it to the correct address. See bullet 10.8.2.4.3 above for the “Additional data” area 0’s address.

The screenshot displays the SIMATIC Manager interface. The top window, titled "CPU315C > PLC_1 [CPU 1215C DC/DC/Rly] > PLC tags > Default tag table [186]", shows a table of PLC tags. The table has columns for Name, Data type, Address, Retain, Visibl..., Acces..., and Comment. The tag AD00_MSW is selected. Below the table, the "AD00_MSW [PLC tag]" properties window is open, showing the "General" tab with fields for Name (AD00_MSW), Data type (Word), Address (%IW204), Retained (checkbox), and Comment. The "History" section shows the date created (10/9/2015 12:11 PM) and last modified (11/4/2015 4:12 PM).

	Name	Data type	Address	Retain	Visibl...	Acces...	Comment
30	Pluto0_I5	Bool	%I26.5	<input type="checkbox"/>	<input checked="" type="checkbox"/>	<input checked="" type="checkbox"/>	Pluto A20 family mapping
31	Pluto0_I6	Bool	%I26.6	<input type="checkbox"/>	<input checked="" type="checkbox"/>	<input checked="" type="checkbox"/>	Pluto A20 family mapping
32	Pluto0_I7	Bool	%I26.7	<input type="checkbox"/>	<input checked="" type="checkbox"/>	<input checked="" type="checkbox"/>	Pluto A20 family mapping
33	AD00_MSW	Word	%IW204	<input type="checkbox"/>	<input checked="" type="checkbox"/>	<input checked="" type="checkbox"/>	
34	AD00_LSW	Word	%IW206	<input type="checkbox"/>	<input checked="" type="checkbox"/>	<input checked="" type="checkbox"/>	
35	AD01_MSW	Word	%IW208	<input type="checkbox"/>	<input checked="" type="checkbox"/>	<input checked="" type="checkbox"/>	
36	AD01_LSW	Word	%IW210	<input type="checkbox"/>	<input checked="" type="checkbox"/>	<input checked="" type="checkbox"/>	
37	P0_Bits	Word	%QW15	<input type="checkbox"/>	<input checked="" type="checkbox"/>	<input checked="" type="checkbox"/>	
38	P0_R0	Word	%QW17	<input type="checkbox"/>	<input checked="" type="checkbox"/>	<input checked="" type="checkbox"/>	
39	P0_R1	Word	%QW19	<input type="checkbox"/>	<input checked="" type="checkbox"/>	<input checked="" type="checkbox"/>	
40	P1_Bits	Word	%QW21	<input type="checkbox"/>	<input checked="" type="checkbox"/>	<input checked="" type="checkbox"/>	

Figure 87 – PROFINET, change the tag list (Siemens).

10.8.2.5.1 Example of Pluto A20 family mapping

See chapter 12, bullet 12.2 for the Global variables mapping and bullet 12.3 for the “Additional Data” mapping. Plus bullet 10.2 for the data format.

	Name	Data type	Address	Retain	Visibl...	Acces...	Comment
1	Pluto0_GM4	Bool	%I23.0	<input type="checkbox"/>	<input checked="" type="checkbox"/>	<input checked="" type="checkbox"/>	Pluto A20 family mapping
2	Pluto0_GM5	Bool	%I23.1	<input type="checkbox"/>	<input checked="" type="checkbox"/>	<input checked="" type="checkbox"/>	Pluto A20 family mapping
3	Pluto0_GM6	Bool	%I23.2	<input type="checkbox"/>	<input checked="" type="checkbox"/>	<input checked="" type="checkbox"/>	Pluto A20 family mapping
4	Pluto0_GM7	Bool	%I23.3	<input type="checkbox"/>	<input checked="" type="checkbox"/>	<input checked="" type="checkbox"/>	Pluto A20 family mapping
5	Pluto0_GM8	Bool	%I23.4	<input type="checkbox"/>	<input checked="" type="checkbox"/>	<input checked="" type="checkbox"/>	Pluto A20 family mapping
6	Pluto0_GM9	Bool	%I23.5	<input type="checkbox"/>	<input checked="" type="checkbox"/>	<input checked="" type="checkbox"/>	Pluto A20 family mapping
7	Pluto0_GM10	Bool	%I23.6	<input type="checkbox"/>	<input checked="" type="checkbox"/>	<input checked="" type="checkbox"/>	Pluto A20 family mapping
8	Pluto0_GM11	Bool	%I23.7	<input type="checkbox"/>	<input checked="" type="checkbox"/>	<input checked="" type="checkbox"/>	Pluto A20 family mapping
9	Pluto0_Q0	Bool	%I24.0	<input type="checkbox"/>	<input checked="" type="checkbox"/>	<input checked="" type="checkbox"/>	Pluto A20 family mapping
10	Pluto0_Q1	Bool	%I24.1	<input type="checkbox"/>	<input checked="" type="checkbox"/>	<input checked="" type="checkbox"/>	Pluto A20 family mapping
11	Pluto0_Q2	Bool	%I24.2	<input type="checkbox"/>	<input checked="" type="checkbox"/>	<input checked="" type="checkbox"/>	Pluto A20 family mapping
12	Pluto0_Q3	Bool	%I24.3	<input type="checkbox"/>	<input checked="" type="checkbox"/>	<input checked="" type="checkbox"/>	Pluto A20 family mapping
13	Pluto0_GM0	Bool	%I24.4	<input type="checkbox"/>	<input checked="" type="checkbox"/>	<input checked="" type="checkbox"/>	Pluto A20 family mapping
14	Pluto0_GM1	Bool	%I24.5	<input type="checkbox"/>	<input checked="" type="checkbox"/>	<input checked="" type="checkbox"/>	Pluto A20 family mapping
15	Pluto0_GM2	Bool	%I24.6	<input type="checkbox"/>	<input checked="" type="checkbox"/>	<input checked="" type="checkbox"/>	Pluto A20 family mapping
16	Pluto0_GM3	Bool	%I24.7	<input type="checkbox"/>	<input checked="" type="checkbox"/>	<input checked="" type="checkbox"/>	Pluto A20 family mapping
17	Pluto0_I10	Bool	%I25.0	<input type="checkbox"/>	<input checked="" type="checkbox"/>	<input checked="" type="checkbox"/>	Pluto A20 family mapping
18	Pluto0_I11	Bool	%I25.1	<input type="checkbox"/>	<input checked="" type="checkbox"/>	<input checked="" type="checkbox"/>	Pluto A20 family mapping
19	Pluto0_I12	Bool	%I25.2	<input type="checkbox"/>	<input checked="" type="checkbox"/>	<input checked="" type="checkbox"/>	Pluto A20 family mapping
20	Pluto0_I13	Bool	%I25.3	<input type="checkbox"/>	<input checked="" type="checkbox"/>	<input checked="" type="checkbox"/>	Pluto A20 family mapping
21	Pluto0_I14	Bool	%I25.4	<input type="checkbox"/>	<input checked="" type="checkbox"/>	<input checked="" type="checkbox"/>	Pluto A20 family mapping
22	Pluto0_I15	Bool	%I25.5	<input type="checkbox"/>	<input checked="" type="checkbox"/>	<input checked="" type="checkbox"/>	Pluto A20 family mapping
23	Pluto0_I16	Bool	%I25.6	<input type="checkbox"/>	<input checked="" type="checkbox"/>	<input checked="" type="checkbox"/>	Pluto A20 family mapping
24	Pluto0_I17	Bool	%I25.7	<input type="checkbox"/>	<input checked="" type="checkbox"/>	<input checked="" type="checkbox"/>	Pluto A20 family mapping
25	Pluto0_I0	Bool	%I26.0	<input type="checkbox"/>	<input checked="" type="checkbox"/>	<input checked="" type="checkbox"/>	Pluto A20 family mapping
26	Pluto0_I1	Bool	%I26.1	<input type="checkbox"/>	<input checked="" type="checkbox"/>	<input checked="" type="checkbox"/>	Pluto A20 family mapping
27	Pluto0_I2	Bool	%I26.2	<input type="checkbox"/>	<input checked="" type="checkbox"/>	<input checked="" type="checkbox"/>	Pluto A20 family mapping
28	Pluto0_I3	Bool	%I26.3	<input type="checkbox"/>	<input checked="" type="checkbox"/>	<input checked="" type="checkbox"/>	Pluto A20 family mapping
29	Pluto0_I4	Bool	%I26.4	<input type="checkbox"/>	<input checked="" type="checkbox"/>	<input checked="" type="checkbox"/>	Pluto A20 family mapping
30	Pluto0_I5	Bool	%I26.5	<input type="checkbox"/>	<input checked="" type="checkbox"/>	<input checked="" type="checkbox"/>	Pluto A20 family mapping
31	Pluto0_I6	Bool	%I26.6	<input type="checkbox"/>	<input checked="" type="checkbox"/>	<input checked="" type="checkbox"/>	Pluto A20 family mapping
32	Pluto0_I7	Bool	%I26.7	<input type="checkbox"/>	<input checked="" type="checkbox"/>	<input checked="" type="checkbox"/>	Pluto A20 family mapping
33	AD00_MSW	Word	%IW204	<input type="checkbox"/>	<input checked="" type="checkbox"/>	<input checked="" type="checkbox"/>	
34	AD00_LSW	Word	%IW206	<input type="checkbox"/>	<input checked="" type="checkbox"/>	<input checked="" type="checkbox"/>	

Figure 88 – PROFINET, example of the Pluto A20 tagging (Siemens).

11 GATE-MT, Modbus TCP

The Ethernet gateway GATE-MT is an Ethernet gateway handling the industry Modbus TCP which is defined by Modbus Organization. It is build according to,

- MODBUS Application Protocol Specification, V1.1a, June 4, 2004.
- MODBUS Messaging on TCP/IP Implementation Guide, V1.0a, June 4, 2004.
- Minimum 500 request per seconds for one steady open connection with about 1 ms response time.
- Maximum of 8 client connections.

11.1 Ethernet Connection

The gateway is connected to Ethernet network using standard Ethernet connector and cable according to chapter 0 and 5.1.3.2. Both Ethernet ports have the same functionality and can be connected as desired. Normally Ethernet port 1 shall be used to connect to a network switch and Ethernet port 2 can be used to connect to other Ethernet device on the network if desired.

Each port can handle connection in both 10 and 100 Mbit/s using half or full duplex. The port automatically configures the port so it can be connected without using any special cross connected cabled.

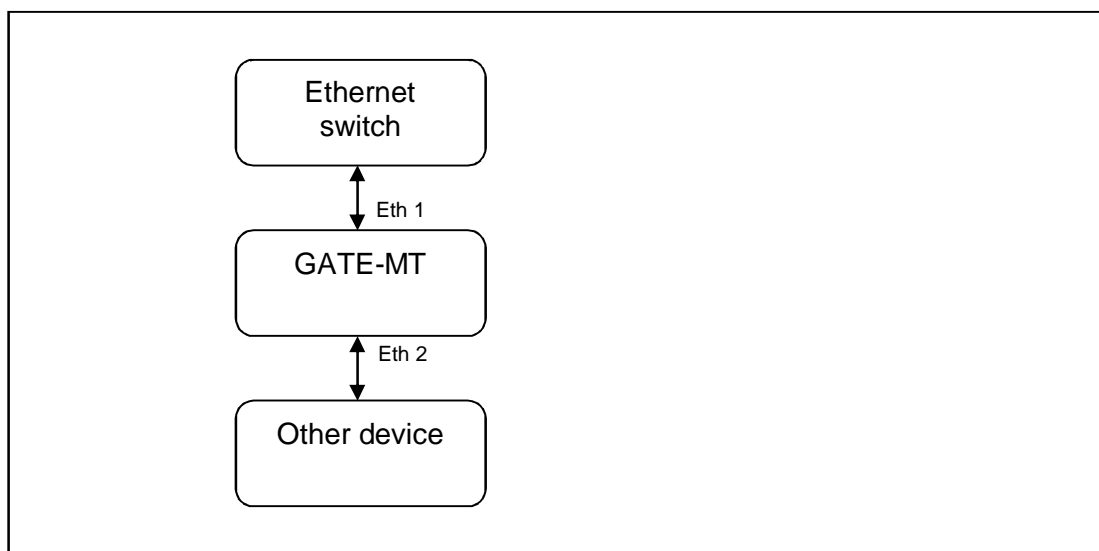

Figure 89 – Modbus TCP, network connection via the gateway device.

11.2 IP address configuration

The default IP address assignment for the unit is using DHCP to get an IP address on the network. If this is not working there are other ways to configure the IP address of the device, see chapter 6.2.

11.3 Status indication

On the gateway with Modbus TCP there are two dual color LEDs for status indications. They are named RUN and ERR (Error). The tables below explain the indicators status information.

11.3.1 RUN



LED		Modbus TCP	Remark
OFF			
GREEN flashing		Waiting for connection.	Flashing with 5 Hz.
GREEN steady		Connection established.	

Table 29, Modbus TCP, RUN status indication behavior.

11.3.2 ERR



LED		Modbus TCP	Remark
OFF		No error.	
RED flashing		System error.	Flashing with 2 Hz. Need device replacement.
RED steady		Communication error.	Need device replacement.

Table 30, Modbus TCP, ERR status indication behavior.

11.4 Service port information

The Modbus service is using several network ports on the device.

Port		Description
TCP	502	Modbus TCP port.

Table 31, Modbus TCP, service port information.

11.5 Integration and configuration

The integration of the device into a system is depending on the system controller.

By default the device uses DHCP to get its IP address and then the easiest way to get this IP address is to use the terminal interface and the “bw” command.

When the IP address is known then standard Modbus TCP communication can be setup using methods described in the appendix for Modbus TCP, see chapter 0.

In this chapter there is a sub chapter (19.6) describing the configuration of the device from the master PLC or by another controller unit. It is recommended to write the complete configuration area even only data need to be changed from the default values. This helps if replacing an existing device with a device used in other machine/system with other configuration then the default settings.

11.6 ABB AC500 integration

This example shows a simple implementation of the Gate-MT in an ABB AC500 PM573-ETH controller using Automation Builder V1.1.1.1717. It doesn't show error handling, it's up to the user to implement this.

The example shows, by using a simple state-machine, how the different steps are done. Configuring, reading status of Pluto units online, reading global data, reading additional data, and sending data to the Pluto, via the Gate-MT.

This example does not explain in detail the workings of the ABB AC500 and CoDeSys environment. For this refer to its relevant documentation.

11.6.1 Hardware configuration

Add the "Modbus_TCP_IP_Server" object to the "Ethernet-Protocols" object by using the "Add object" function. Choose "Modbus" and then "Modbus TCP/IP Server".

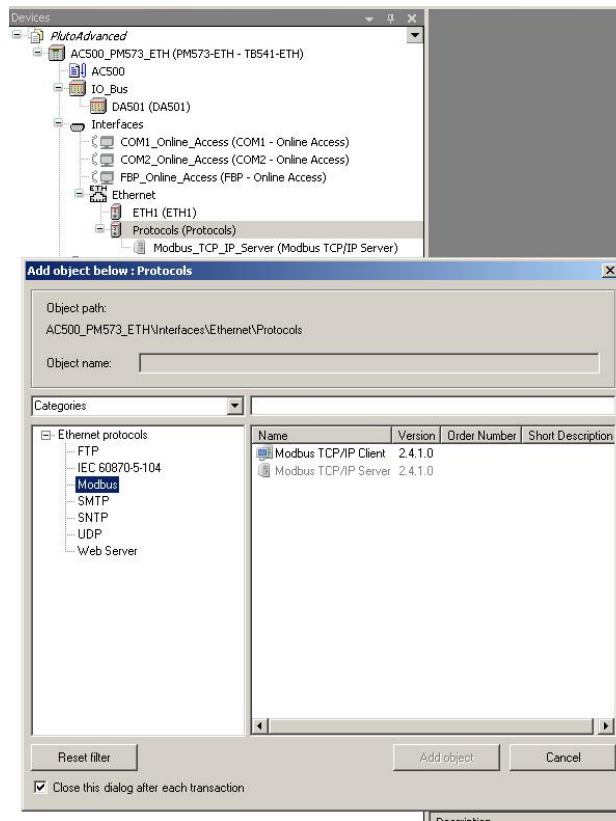

In this example the default setting are used.

Parameter	Type	Value	Default Value	Unit	Description
Server connections	BYTE(0..12)	0	0		Number of sockets reserved for OMB server connections
Task timeout	WORD(1..60000)	20	20	100 ms	Task timeout
OMB time	WORD(1..60000)	10	10	100 ms	OMB time
Send timeout	DWORD(0..2000000000)	0	0	ms	Send timeout
Connect timeout	DWORD(0..2000000000)	18000	0	ms	Connect timeout
Close timeout	DWORD(0..2000000000)	0	0	ms	Close timeout
Byte order	Enumeration of BYTE	Big endian	Big endian		Big endian = 1; Little endian = 0
Disable write to %MB0.x from	WORD(0..65535)	0	0		Disable write access beginning with byte in area %MB0.x
Disable write to %MB0.x to	WORD(0..65535)	0	0		Disable write access ending with byte in area %MB0.x
Disable read to %MB0.x from	WORD(0..65535)	0	0		Disable read access beginning with byte in area %MB0.x
Disable read to %MB0.x to	WORD(0..65535)	0	0		Disable read access ending with byte in area %MB0.x
Disable write to %MB1.x from	WORD(0..65535)	0	0		Disable write access beginning with byte in area %MB1.x
Disable write to %MB1.x to	WORD(0..65535)	0	0		Disable write access ending with byte in area %MB1.x
Disable read to %MB1.x from	WORD(0..65535)	0	0		Disable read access beginning with byte in area %MB1.x
Disable read to %MB1.x to	WORD(0..65535)	0	0		Disable read access ending with byte in area %MB1.x
Assigned interface	BYTE	1	1		Assigned interface

11.6.2 CoDeSys implementation

This part will show how the gateway is read and written in the CoDeSys environment.

11.6.2.1 Structured Flow Chart Implementation

Create a Structured Flow Chart POU, Program – SFC, here named “Modbus_TCP_GateMT”.



11.6.2.1.1 Variables

The data to and from the gateway are stored in the following global variables in the CoDeSys environment.

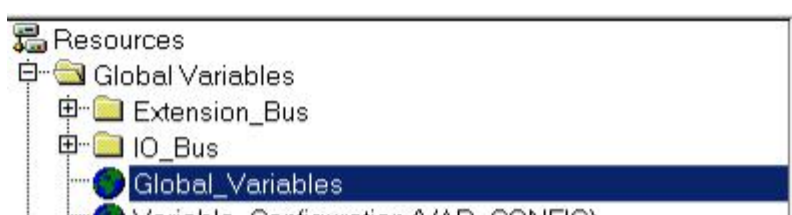

Please note that the Packets to Pluto variable here is initialized in [0] and [1] so all packets transmitted are valid when transmitted.

```
0001 VAR_GLOBAL
0002 Status_Pluto_Units_Online:DWORD:=0;
0003 Global_Data_Pluto_Unit_0_to_31:ARRAY [0..31] OF DWORD:=0,0,0,0,0,0,0,0,0,0,0,0,0,0,0,0,0,0,0,0,0,0,0,0,0,0,0,0,0,0,0,0;
0004 Additional_Data_Area_0_to_31:ARRAY [0..31] OF DWORD:=0,0,0,0,0,0,0,0,0,0,0,0,0,0,0,0,0,0,0,0,0,0,0,0,0,0,0,0,0,0,0,0;
0005 Packets_To_Pluto_0_to_3:ARRAY [0..13] OF WORD:=14,15,0,0,0,0,0,0,0,0,0,0,0,0; (* Length, Valid packets, Packet 0, 16 bits, two 16-bit registers, etc *)
0006 END_VAR
```

The following variables are initialized in the SFC, they concern the configuration of the gateway. All of the 32 additional data areas available are set to listen to the Pluto node equal to its own designation. This means “Additional data area 00” will listen for data from Pluto node 0, “Additional data area 01” from Pluto node1, and so on. The IO type is set to 1 in all of the areas, which means they’re all listening for a block with user number 1, be it any type of “ToGateway_User_...”, A, B or C, as used in the Pluto project for each Pluto node.

PROGRAM ModbusTCP_GateMT

VAR CONSTANT

IP_Adress_Gate_MT:STRING:='192.168.0.100';(* Chosen by the user *)

(* See Appendix F, bullet 17.6 for the structure of the configuration telegram. *)

Length:WORD:=42; (* Length of Modbus TCP configuration telegram, do not change *)

Enable_Data_To_Pluto_Packets:WORD:=15; (* Enables up to four packets to Pluto, value 0 to 15 decimal, 0000 (none) - 1111 (all four) binary *)

Data_To_Pluto_Timeout:WORD:=0; (* Sets the timeout, 0 means no timeout or set to 1000 - 60000 *)

Expected_Pluto_NodesLSW:WORD:=65535; (* Pluto nodes 0 - 15, 65535 decimal for all 0 to 15, 1111 1111 1111 1111 binary, LSB is Pluto 0, MSB is Pluto 15 *)

Expected_Pluto_NodesMSW:WORD:=65535; (* Pluto nodes 16 - 31 65535 decimal for all 16 to 31, 1111 1111 1111 1111 binary, LSB is Pluto 16, MSB is Pluto 31 *)

Additional_Data_Area_0_Pluto_Node_Number:BYTE:=0; (* High Byte is Pluto node number, Low Byte is IO type; for IO type see bullet 4.3.3 in the Pluto gateway manual *)

Additional_Data_Area_0_IO_Type:BYTE:=1; (* This and all 32 additional data areas below are calculated and in the Init step and inserted into the CfgData array below *)

Additional_Data_Area_1_Pluto_Node_Number:BYTE:=1;

Additional_Data_Area_1_IO_Type:BYTE:=1;

Additional_Data_Area_2_Pluto_Node_Number:BYTE:=2;

Additional_Data_Area_2_IO_Type:BYTE:=1;

Additional_Data_Area_3_Pluto_Node_Number:BYTE:=3;

Additional_Data_Area_3_IO_Type:BYTE:=1;

```

Additional_Data_Area_4_Pluto_Node_Number:BYTE:=4;
Additional_Data_Area_4_IO_Type:BYTE:=1;
Additional_Data_Area_5_Pluto_Node_Number:BYTE:=5;
Additional_Data_Area_5_IO_Type:BYTE:=1;
Additional_Data_Area_6_Pluto_Node_Number:BYTE:=6;
Additional_Data_Area_6_IO_Type:BYTE:=1;
Additional_Data_Area_7_Pluto_Node_Number:BYTE:=7;
Additional_Data_Area_7_IO_Type:BYTE:=1;
Additional_Data_Area_8_Pluto_Node_Number:BYTE:=8;
Additional_Data_Area_8_IO_Type:BYTE:=1;
Additional_Data_Area_9_Pluto_Node_Number:BYTE:=9;
Additional_Data_Area_9_IO_Type:BYTE:=1;
Additional_Data_Area_10_Pluto_Node_Number:BYTE:=10;
Additional_Data_Area_10_IO_Type:BYTE:=1;
Additional_Data_Area_11_Pluto_Node_Number:BYTE:=11;
Additional_Data_Area_11_IO_Type:BYTE:=1;
Additional_Data_Area_12_Pluto_Node_Number:BYTE:=12;
Additional_Data_Area_12_IO_Type:BYTE:=1;
Additional_Data_Area_13_Pluto_Node_Number:BYTE:=13;
Additional_Data_Area_13_IO_Type:BYTE:=1;
Additional_Data_Area_14_Pluto_Node_Number:BYTE:=14;
Additional_Data_Area_14_IO_Type:BYTE:=1;
Additional_Data_Area_15_Pluto_Node_Number:BYTE:=15;
Additional_Data_Area_15_IO_Type:BYTE:=1;
Additional_Data_Area_16_Pluto_Node_Number:BYTE:=16;
Additional_Data_Area_16_IO_Type:BYTE:=1;
Additional_Data_Area_17_Pluto_Node_Number:BYTE:=17;
Additional_Data_Area_17_IO_Type:BYTE:=1;
Additional_Data_Area_18_Pluto_Node_Number:BYTE:=18;
Additional_Data_Area_18_IO_Type:BYTE:=1;
Additional_Data_Area_19_Pluto_Node_Number:BYTE:=19;
Additional_Data_Area_19_IO_Type:BYTE:=1;
Additional_Data_Area_20_Pluto_Node_Number:BYTE:=20;
Additional_Data_Area_20_IO_Type:BYTE:=1;
Additional_Data_Area_21_Pluto_Node_Number:BYTE:=21;
Additional_Data_Area_21_IO_Type:BYTE:=1;
Additional_Data_Area_22_Pluto_Node_Number:BYTE:=22;
Additional_Data_Area_22_IO_Type:BYTE:=1;
Additional_Data_Area_23_Pluto_Node_Number:BYTE:=23;
Additional_Data_Area_23_IO_Type:BYTE:=1;
Additional_Data_Area_24_Pluto_Node_Number:BYTE:=24;
Additional_Data_Area_24_IO_Type:BYTE:=1;
Additional_Data_Area_25_Pluto_Node_Number:BYTE:=25;
Additional_Data_Area_25_IO_Type:BYTE:=1;
Additional_Data_Area_26_Pluto_Node_Number:BYTE:=26;
Additional_Data_Area_26_IO_Type:BYTE:=1;
Additional_Data_Area_27_Pluto_Node_Number:BYTE:=27;
Additional_Data_Area_27_IO_Type:BYTE:=1;
Additional_Data_Area_28_Pluto_Node_Number:BYTE:=28;
Additional_Data_Area_28_IO_Type:BYTE:=1;
Additional_Data_Area_29_Pluto_Node_Number:BYTE:=29;
Additional_Data_Area_29_IO_Type:BYTE:=1;
Additional_Data_Area_30_Pluto_Node_Number:BYTE:=30;
Additional_Data_Area_30_IO_Type:BYTE:=1;
Additional_Data_Area_31_Pluto_Node_Number:BYTE:=31;
Additional_Data_Area_31_IO_Type:BYTE:=1;
Data_To_Pluto_Cycle_Time:WORD:=100; (* How often in ms the value is sent to the Pluto bus, lower value means high bus
load, value 4 - 255 *)

NotUsed0:WORD:=0;
NotUsed1:WORD:=0;
NotUsed2:WORD:=0;
Gateway_Node_Address:WORD:=0; (* Value between 0-15, can also be set by DIP switch on the gateway *)

```

END_VAR

VAR

```

ModbusTCP: ETH_MOD_MAST;
CfgData:ARRAY [0..41] OF WORD:=
Length,
Enable_Data_To_Pluto_Packets,
Data_To_Pluto_Timeout,
Expected_Pluto_NodesMSW,
Expected_Pluto_NodesLSW,
0, (* Here and below follows the 32 (0 - 31) additional data areas available in the Gate-MT *)
0, (* The value is calculated in the Init step and inserted into the CfgData but they need to be initialised, set to zero *)
0, (* The value depends on the Additional_Data_Area_X_Pluto_Node_Number and
Additional_Data_Area_X_IO_Type above *)
0, (* Where X is 0 - 31 *)
0,
0,

```

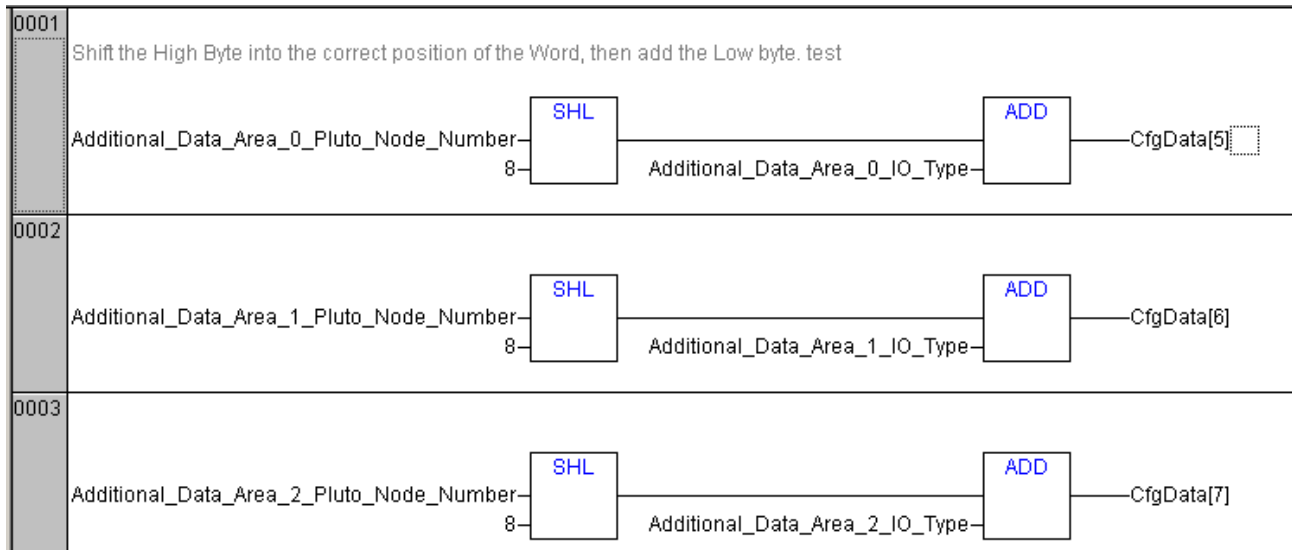

11.6.2.1.3 Init step

This step takes the contents of the variables initialized above and puts in the correct place in the configuration array, CfgData.

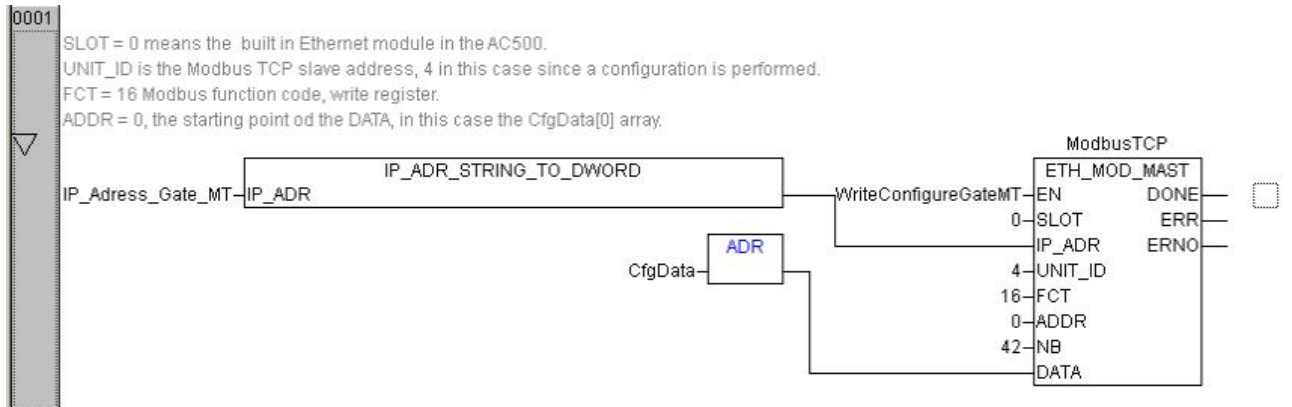

11.6.2.1.4 Configuration step, Write

This step used the “ETH_MOD_MAST” block available in the CoDeSys environment. It is setup according to the rules described in Appendix F, bullet 17.6.



11.6.2.1.5 Pluto units online, Read

Reads which Pluto unit nodes are online on the Pluto bus.

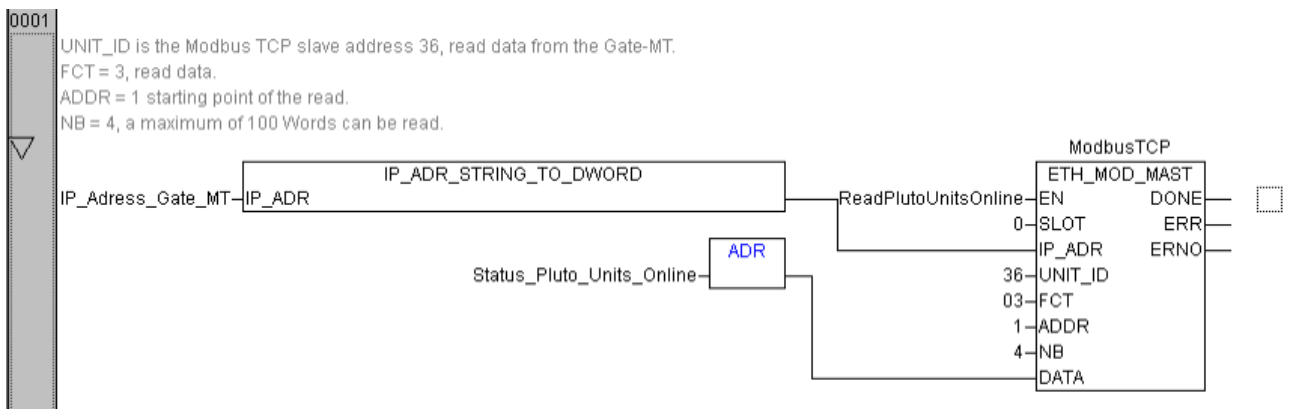

11.6.2.1.6 Global Data, Read

Reads the global data of all Pluto units available on the Pluto bus, the data which all units always transmit. Nothing needs to be configured in the Pluto unit.

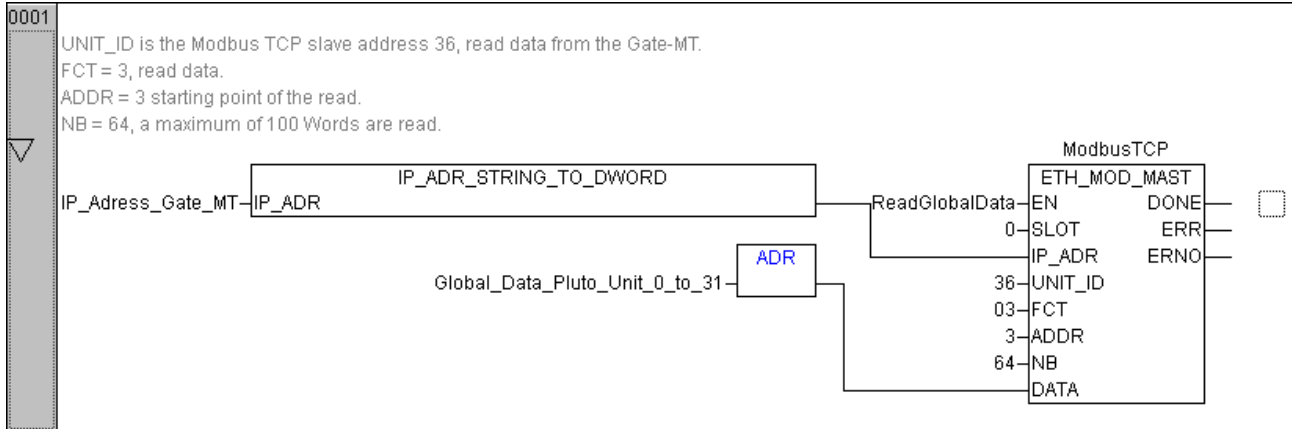

11.6.2.1.7 Additional Data, Read

Reads the additional data that is transmitted on the Pluto bus by the Pluto units. The Pluto project needs to be setup using the “Ext01.fps” block library and use a suitable block from that library.

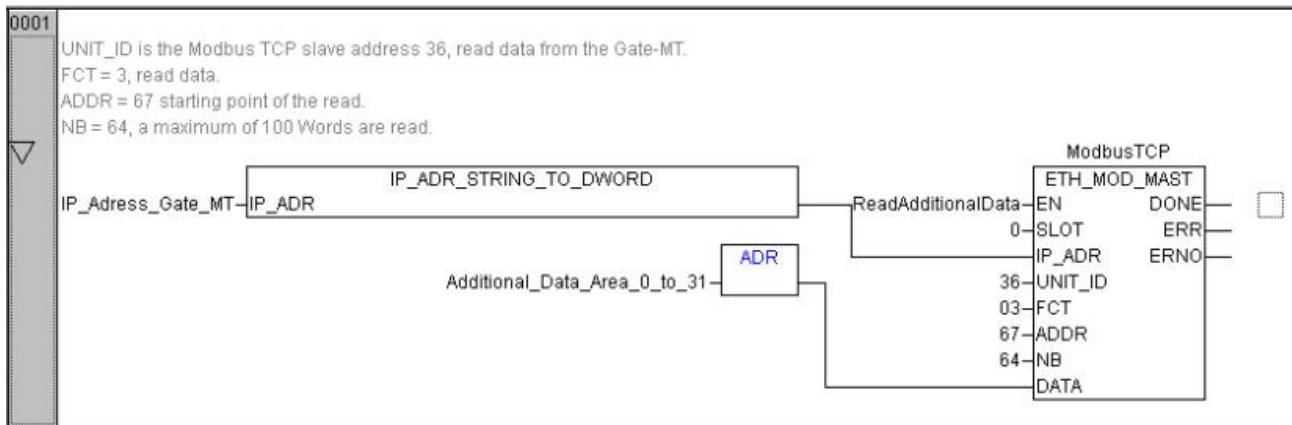

11.6.2.1.8 Packets to Pluto, Write

Used to transmit data to the Pluto units, via the gateway onto the Pluto bus. The Pluto unit that wishes to pick up the packet needs to be configured to do so. See the Pluto chapter.

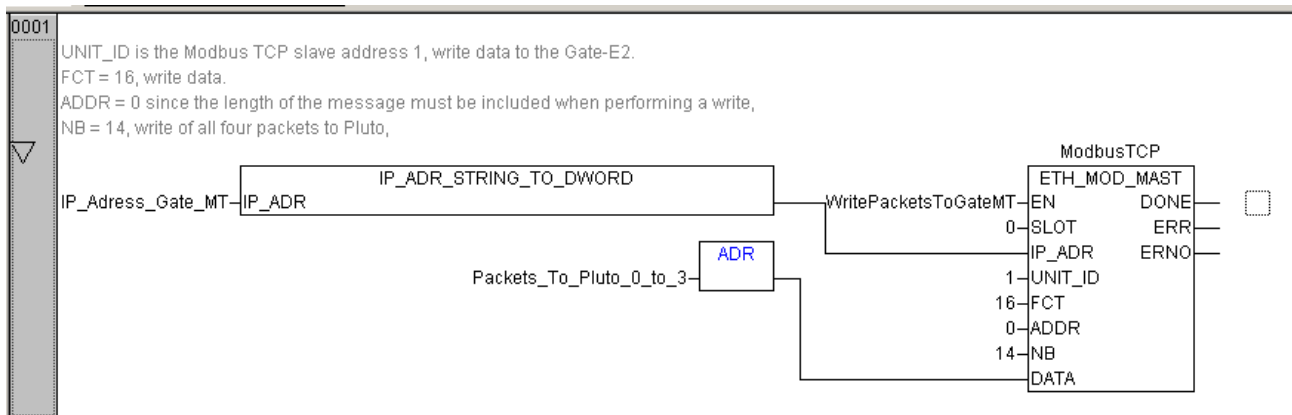

11.6.2.2 Task configuration

Create a task under; Resources – Task configuration, calling the SFC POU at a suitable interval, for example as shown in the pictures.

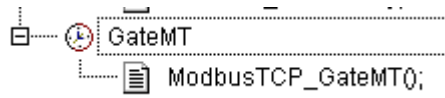

Taskattributes

Name: GateMT

Priority(0..31): 10

Type

- cyclic
- freewheeling
- triggered by event
- triggered by external event

Properties

Interval (e.g. t#200ms): T#5ms ms

Watchdog

Activate watchdog

Time (e.g. t#200ms): %

Sensitivity: 1

Program Call

Program Call: ModbusTCP_GateMT(); ...

12 Data to/from Pluto

This chapter will describe the different type of data sent to/from Pluto via the gateway. It will also be the reference chapter regarding encoding of the data.

12.1 Pluto Status

The size of this module is 4 bytes or 2 words. These data contain information about which Pluto units that are active on the Pluto bus. When a Pluto is active the corresponding bit is set to "1".

The coding of the status data in byte is,

Byte	MSB							LSB
0	Pluto 7	Pluto 6	Pluto 5	Pluto 4	Pluto 3	Pluto 2	Pluto 1	Pluto 0
1	Pluto 15	Pluto 14	Pluto 13	Pluto 12	Pluto 11	Pluto 10	Pluto 9	Pluto 8
2	Pluto 23	Pluto 22	Pluto 21	Pluto 20	Pluto 19	Pluto 18	Pluto 17	Pluto 16
3	Pluto 31	Pluto 30	Pluto 29	Pluto 28	Pluto 27	Pluto 26	Pluto 25	Pluto 24

Table 32, Pluto Status coding.

12.2 Global Data from Pluto

When selected, the global Pluto variables are always transferred. There are 32 global Pluto variables from each Pluto and they are always available on the Pluto bus, 1024 for a full net with 32 Pluto. All variables are bit variables.

The size of this module is 4 bytes or 2 words. Pluto global variables are of different types and are depending on which type of Pluto the data is coming from. The table below list different type of variables and the following tables list the layout of data from different type of Pluto:

Ix.y	Inputs data port y from Pluto x.
Qx.y	Safety outputs port y from Pluto x.
GMx.y	Global memories y from Pluto x.
ASIx.y	Input AS-i safety slave y from Pluto x.

Table 33, Pluto variables.

The coding of the Pluto variables for Pluto A20 and Double family in byte is,

Byte	MSB							LSB
0	Ix.7	Ix.6	Ix.5	Ix.4	Ix.3	Ix.2	Ix.1	Ix.0
1	Ix.17	Ix.16	Ix.15	Ix.14	Ix.13	Ix.12	Ix.11	Ix.10
2	GMx.3	GMx.2	GMx.1	GMx.0	Qx.3	Qx.2	Qx.1	Qx.0
3	GMx.11	GMx.10	GMx.9	GMx.8	GMx.7	GMx.6	GMx.5	GMx.4

Table 34, Pluto global data for Pluto A20 and Double family (x is Pluto node number).

The coding of the status variables for Pluto AS-i family in byte is,

Byte	MSB							LSB
0	ASIx.7	ASIx.6	ASIx.5	ASIx.4	ASIx.3	ASIx.2	ASIx.1	Ix.0
1	ASIx.15	ASIx.14	ASIx.13	ASIx.12	ASIx.11	ASIx.10	ASIx.9	ASIx.8
2	GMx.3	GMx.2	GMx.1	GMx.0	Qx.3	Qx.2	Qx.1	Qx.0
3	GMx.11	GMx.10	GMx.9	GMx.8	GMx.7	GMx.6	GMx.5	GMx.4

Table 35, Pluto global data for Pluto AS-i family (x is Pluto node number and ASIx.y is the safety node y).

The coding of the Pluto variables for Pluto B42 AS-i in byte is,

Byte	MSB							LSB
0	GMx.3	GMx.2	GMx.1	GMx.0	Ix.3	Ix.2	Ix.1	Ix.0
1	GMx.11	GMx.10	GMx.9	GMx.8	GMx.7	GMx.6	GMx.5	GMx.4
2	GMx.19	GMx.18	GMx.17	GMx.16	GMx.15	GMx.14	GMx.13	GMx.12
3	GMx.27	GMx.26	GMx.25	GMx.24	GMx.23	GMx.22	GMx.21	GMx.20

Table 36, Pluto global data for Pluto B42 AS-i (x is Pluto node number).

The coding of the Pluto variables for Pluto O2 in byte is,

Byte	MSB							LSB
0	-	-	-	-	-	-	-	Ix.1 Ix.0
1	-	-	-	-	-	-	-	Ix.11 Ix.10
2	GMx.3	GMx.2	GMx.1	GMx.0	-	-	-	Qx.1 Qx.0
3	GMx.11	GMx.10	GMx.9	GMx.8	GMx.7	GMx.6	GMx.5	GMx.4

Table 37, Pluto global data for Pluto O2 (x is Pluto node number).

12.3 Additional Data from Pluto

Every Pluto on the Pluto bus can send out additional data blocks where each block has:

- The Pluto node number.
- An IO-type number (for user block a user identity number).
 - 0 (zero) data is not used.
 - 1-99 are user defined numbers used at the additional data blocks in PLC code.
 - ≥100 are standard additional data types (see tables below).
 - 111 are IO-type for Pluto global data.
- 32 bit of data according to IO-type.

The configuration of the additional data is normally done using application objects on the industry protocol from the connected PLC system. It can also be done via the terminal port using commands according to chapter 0.

12.3.1 Layout of additional data

All blocks which can be used in the Pluto PLC program for sending additional data are listed below.

Note: For the user defined blocks each block in each Pluto must be allocated a unique number between 1 and 99 (on input “No”) to identify the data block. This number is then used to identify the block in the receiving field bus system.

The standard blocks have defined data.

12.3.1.1 User defined blocks

User defined “ToGateway_User_A” (ToGateway_UserNumber_x),

Byte	MSB							LSB
0	Reg_0.7	Reg_0.6	Reg_0.5	Reg_0.4	Reg_0.3	Reg_0.2	Reg_0.1	Reg_0.0
1	Reg_0.15	Reg_0.14	Reg_0.13	Reg_0.12	Reg_0.11	Reg_0.10	Reg_0.9	Reg_0.8
2	Reg_1.7	Reg_1.6	Reg_1.5	Reg_1.4	Reg_1.3	Reg_1.2	Reg_1.1	Reg_1.0
3	Reg_1.15	Reg_1.14	Reg_1.13	Reg_1.12	Reg_1.11	Reg_1.10	Reg_1.9	Reg_1.8

Table 38, User defined block type A (Unique user number (x) set in block).

User defined “ToGateway_User_B” (ToGateway_UserNumber_x),

Byte	MSB							LSB
0	Reg_0.7	Reg_0.6	Reg_0.5	Reg_0.4	Reg_0.3	Reg_0.2	Reg_0.1	Reg_0.0
1	Reg_0.15	Reg_0.14	Reg_0.13	Reg_0.12	Reg_0.11	Reg_0.10	Reg_0.9	Reg_0.8
2	Bit_7	Bit_6	Bit_5	Bit_4	Bit_3	Bit_2	Bit_1	Bit_0
3	Pluto Error Code							

Table 39, User defined block type B (Unique user number (x) set in block).

User defined “ToGateway_User_C” (ToGateway_UserNumber_x),

Byte	MSB							LSB
0	Reg_0.7	Reg_0.6	Reg_0.5	Reg_0.4	Reg_0.3	Reg_0.2	Reg_0.1	Reg_0.0
1	Reg_0.15	Reg_0.14	Reg_0.13	Reg_0.12	Reg_0.11	Reg_0.10	Reg_0.9	Reg_0.8
2	Bit_7	Bit_6	Bit_5	Bit_4	Bit_3	Bit_2	Bit_1	Bit_0
3	Bit_15	Bit_14	Bit_13	Bit_12	Bit_11	Bit_10	Bit_9	Bit_8

Table 40, User defined block type C (Unique user number (x) set in block).

12.3.1.2 Standard blocks

ASlx.y is safety slave y from Pluto AS-i unit (x is Pluto node number).

Standard "ToGateway_ErrorCode" (IO-type number 100, 0x64),

Byte	MSB							LSB
0	-	-	-	-	-	-	-	-
1	-	-	-	-	-	-	-	-
2	-	-	-	-	-	-	-	-
3	Pluto Error Code							

Table 41, Standard block "ToGateway_ErrorCode" ('-' character indicate undefined value).

Standard "ToGateway_B46_I20_I47" (IO-type number 101, 0x65),

Byte	MSB							LSB
0	lx.27	lx.26	lx.25	lx.24	lx.23	lx.22	lx.21	lx.20
1	lx.37	lx.36	lx.35	lx.34	lx.33	lx.32	lx.31	lx.30
2	lx.47	lx.46	lx.45	lx.44	lx.43	lx.42	lx.41	lx.40
3	Pluto Error Code							

Table 42, Standard block "ToGateway_B46_I20_I47".

Standard "ToGateway_ASi_16_31_Safe" (IO-type number 102, 0x66),

Byte	MSB							LSB
0	lx.13*	lx.12*	lx.11*	lx.10*	lx.3*	lx.2*	lx.1*	-
1	ASlx.23	ASlx.22	ASlx.21	ASlx.20	ASlx.19	ASlx.18	ASlx.17	ASlx.16
2	ASlx.31	ASlx.30	ASlx.29	ASlx.28	ASlx.27	ASlx.26	ASlx.25	ASlx.24
3	Pluto Error Code							

Table 43, Standard block "ToGateway_ASi_16_31_Safe" ('-' undefined value / '*' undefined for B42 AS-i).

Standard "ToGateway_ASi_1_3_NonSafe_In" (IO-type number 103, 0x67),

Byte	MSB							LSB
0	-	-	-	-	-	-	-	-
1	Ax.1B.4	Ax.1B.3	Ax.1B.2	Ax.1B.1	Ax.1.4	Ax.1.3	Ax.1.2	Ax.1.1
2	Ax.2B.4	Ax.2B.3	Ax.2B.2	Ax.2B.1	Ax.2.4	Ax.2.3	Ax.2.2	Ax.2.1
3	Ax.3B.4	Ax.3B.3	Ax.3B.2	Ax.3B.1	Ax.3.4	Ax.3.3	Ax.3.2	Ax.3.1

Table 44, Standard block "ToGateway_ASi_1_3_NonSafe_In" ('-' undefined value).

Standard "ToGateway_ASi_4_7_NonSafe_In" (IO-type number 104, 0x68),

Byte	MSB							LSB
0	Ax.4B.4	Ax.4B.3	Ax.4B.2	Ax.4B.1	Ax.4.4	Ax.4.3	Ax.4.2	Ax.4.1
1	Ax.5B.4	Ax.5B.3	Ax.5B.2	Ax.5B.1	Ax.5.4	Ax.5.3	Ax.5.2	Ax.5.1
2	Ax.6B.4	Ax.6B.3	Ax.6B.2	Ax.6B.1	Ax.6.4	Ax.6.3	Ax.6.2	Ax.6.1
3	Ax.7B.4	Ax.7B.3	Ax.7B.2	Ax.7B.1	Ax.7.4	Ax.7.3	Ax.7.2	Ax.7.1

Table 45, Standard block "ToGateway_ASi_4_7_NonSafe_In".

Standard "ToGateway_ASi_8_11_NonSafe_In" (IO-type number 105, 0x69),

Byte	MSB							LSB
0	Ax.8B.4	Ax.8B.3	Ax.8B.2	Ax.8B.1	Ax.8.4	Ax.8.3	Ax.8.2	Ax.8.1
1	Ax.9B.4	Ax.9B.3	Ax.9B.2	Ax.9B.1	Ax.9.4	Ax.9.3	Ax.9.2	Ax.9.1
2	Ax.10B.4	Ax.10B.3	Ax.10B.2	Ax.10B.1	Ax.10.4	Ax.10.3	Ax.10.2	Ax.10.1
3	Ax.11B.4	Ax.11B.3	Ax.11B.2	Ax.11B.1	Ax.11.4	Ax.11.3	Ax.11.2	Ax.11.1

Table 46, Standard block "ToGateway_ASi_8_11_NonSafe_In".

Standard “ToGateway_ASi_12_15_NonSafe_In” (IO-type number 106, 0x6A),

Byte	MSB							LSB
0	Ax.12B.4	Ax.12B.3	Ax.12B.2	Ax.12B.1	Ax.12.4	Ax.12.3	Ax.12.2	Ax.12.1
1	Ax.13B.4	Ax.13B.3	Ax.13B.2	Ax.13B.1	Ax.13.4	Ax.13.3	Ax.13.2	Ax.13.1
2	Ax.14B.4	Ax.14B.3	Ax.14B.2	Ax.14B.1	Ax.14.4	Ax.14.3	Ax.14.2	Ax.14.1
3	Ax.15B.4	Ax.15B.3	Ax.15B.2	Ax.15B.1	Ax.15.4	Ax.15.3	Ax.15.2	Ax.15.1

Table 47, Standard block “ToGateway_ASi_12_15_NonSafe_In”.

Standard “ToGateway_ASi_16_19_NonSafe_In” (IO-type number 107, 0x6B),

Byte	MSB							LSB
0	Ax.16B.4	Ax.16B.3	Ax.16B.2	Ax.16B.1	Ax.16.4	Ax.16.3	Ax.16.2	Ax.16.1
1	Ax.17B.4	Ax.17B.3	Ax.17B.2	Ax.17B.1	Ax.17.4	Ax.17.3	Ax.17.2	Ax.17.1
2	Ax.18B.4	Ax.18B.3	Ax.18B.2	Ax.18B.1	Ax.18.4	Ax.18.3	Ax.18.2	Ax.18.1
3	Ax.19B.4	Ax.19B.3	Ax.19B.2	Ax.19B.1	Ax.19.4	Ax.19.3	Ax.19.2	Ax.19.1

Table 48, Standard block “ToGateway_ASi_16_19_NonSafe_In”.

Standard “ToGateway_ASi_20_23_NonSafe_In” (IO-type number 108, 0x6C),

Byte	MSB							LSB
0	Ax.20B.4	Ax.20B.3	Ax.20B.2	Ax.20B.1	Ax.20.4	Ax.20.3	Ax.20.2	Ax.20.1
1	Ax.21B.4	Ax.21B.3	Ax.21B.2	Ax.21B.1	Ax.21.4	Ax.21.3	Ax.21.2	Ax.21.1
2	Ax.22B.4	Ax.22B.3	Ax.22B.2	Ax.22B.1	Ax.22.4	Ax.22.3	Ax.22.2	Ax.22.1
3	Ax.23B.4	Ax.23B.3	Ax.23B.2	Ax.23B.1	Ax.23.4	Ax.23.3	Ax.23.2	Ax.23.1

Table 49, Standard block “ToGateway_ASi_20_23_NonSafe_In”.

Standard “ToGateway_ASi_24_27_NonSafe_In” (IO-type number 109, 0x6D),

Byte	MSB							LSB
0	Ax.24B.4	Ax.24B.3	Ax.24B.2	Ax.24B.1	Ax.24.4	Ax.24.3	Ax.24.2	Ax.24.1
1	Ax.25B.4	Ax.25B.3	Ax.25B.2	Ax.25B.1	Ax.25.4	Ax.25.3	Ax.25.2	Ax.25.1
2	Ax.26B.4	Ax.26B.3	Ax.26B.2	Ax.26B.1	Ax.26.4	Ax.26.3	Ax.26.2	Ax.26.1
3	Ax.27B.4	Ax.27B.3	Ax.27B.2	Ax.27B.1	Ax.27.4	Ax.27.3	Ax.27.2	Ax.27.1

Table 50, Standard block “ToGateway_ASi_24_27_NonSafe_In”.

Standard “ToGateway_ASi_28_31_NonSafe_In” (IO-type number 110, 0x6E),

Byte	MSB							LSB
0	Ax.28B.4	Ax.28B.3	Ax.28B.2	Ax.28B.1	Ax.28.4	Ax.28.3	Ax.28.2	Ax.28.1
1	Ax.29B.4	Ax.29B.3	Ax.29B.2	Ax.29B.1	Ax.29.4	Ax.29.3	Ax.29.2	Ax.29.1
2	Ax.30B.4	Ax.30B.3	Ax.30B.2	Ax.30B.1	Ax.30.4	Ax.30.3	Ax.30.2	Ax.30.1
3	Ax.31B.4	Ax.31B.3	Ax.31B.2	Ax.31B.1	Ax.31.4	Ax.31.3	Ax.31.2	Ax.31.1

Table 51, Standard block “ToGateway_ASi_28_31_NonSafe_In”.

Standard “GLOBAL DATA” (IO-type number 111, 0x6F),

Byte	MSB							LSB
0		See 12.2						
1								
2								
3								

Table 52, Standard block “GLOBAL DATA”.

Standard “ToGateway_B42_ASi_I20_I47” (IO-type number 112, 0x70),

Byte	MSB							LSB
0	Ix.27	Ix.26	Ix.25	Ix.24	Ix.23	Ix.22	Ix.21	Ix.20
1	Ix.37	Ix.36	Ix.35	Ix.34	Ix.33	Ix.32	Ix.31	Ix.30
2	Ix.47	Ix.46	Ix.45	Ix.44	Ix.43	Ix.42	Ix.41	Ix.40
3	Pluto Error Code							

Table 53, Standard block “ToGateway_B42_ASi_I20_I47”.

Standard “ToGateway_ASi_1_15_Safe” (IO-type number 113, 0x71),

Byte	MSB							LSB
0	lx.17	lx.16	lx.15	lx.14	lx.13	lx.12	lx.11	lx.10
1	ASlx.7	ASlx.6	ASlx.5	ASlx.4	ASlx.3	ASlx.2	ASlx.1	0
2	ASlx.15	ASlx.14	ASlx.13	ASlx.12	ASlx.11	ASlx.10	ASlx.9	ASlx.8
3	Pluto Error Code							

Table 54, Standard block “ToGateway_ASi_1_15_Safe”.

Standard “ToGateway_D45_I20_I47” (IO-type number 114, 0x71),

Byte	MSB							LSB
0	0	lx.26	lx.25	lx.24	lx.23	lx.22	lx.21	lx.20
1	lx.37	lx.36	lx.35	lx.34	lx.33	lx.32	lx.31	lx.30
2	lx.47	lx.46	lx.45	lx.44	lx.43	lx.42	lx.41	lx.40
3	Pluto Error Code							

Table 55, Standard block “ToGateway_D45_I20_I47”.

12.3.2 Programming in Pluto PLC

12.3.2.1 Function block library

To use the function “Additional data from Pluto” the function block library “Ext01_1.fps” must be selected. The library contains all blocks listed above (12.3.1.1 and 0).



Figure 90 – Add function library “Ext01_1.fps”.

12.3.2.2 Use of the function blocks

As described before there are standard blocks and user defined blocks. The standard blocks have a fixed content as for example “ToGateway_B46_I20_I47” transmitting the local inputs and error code of a Pluto B46. The user defined blocks have inputs for bit variables (M, I, Q...) and registers which makes it possible for the user to compose his own telegram.

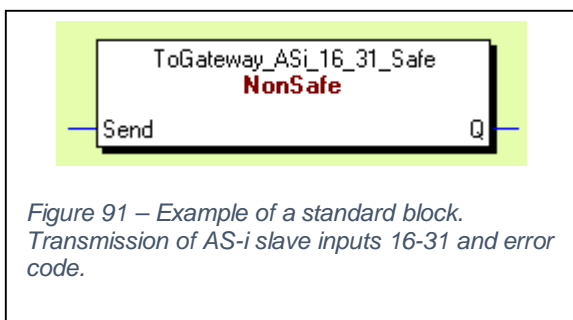

Figure 91 – Example of a standard block. Transmission of AS-i slave inputs 16-31 and error code.

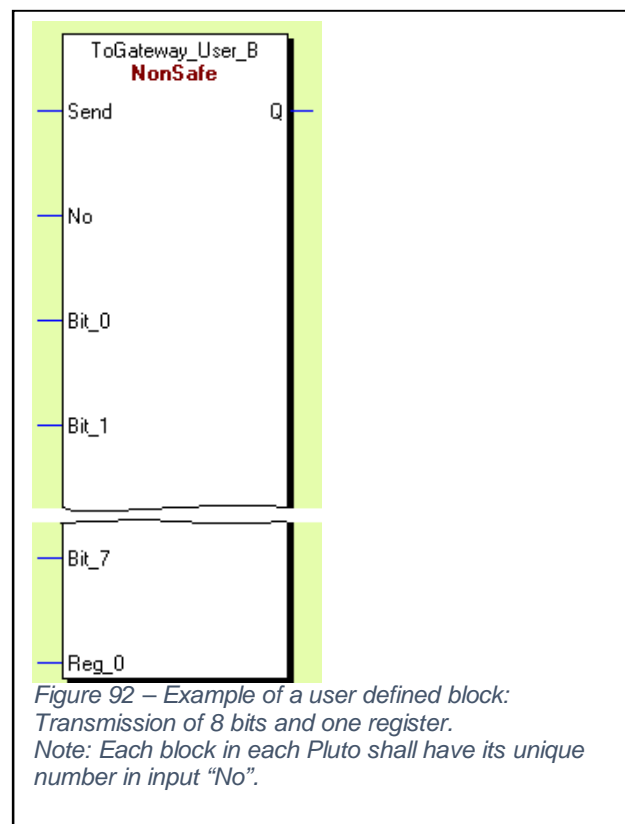

Figure 92 – Example of a user defined block: Transmission of 8 bits and one register. Note: Each block in each Pluto shall have its unique number in input “No”.

Each block generates a CAN telegram on the Pluto bus. In order to control and limit bus load and execution time all blocks have an input named “Send”. When the input conditions for “Send” are true (1) the block transmits a telegram. All blocks have also an output “Q” which is high (1) by transmission and can for example be used for inhibiting other blocks to transmit.

If “Send” is continuously activated a CAN message is transmitted every 10 ms which of course will give the best performance in reaction time. If there is need for limiting the transmission depends on how many Pluto units there are on the bus and how many of these blocks are used.

Note: Pluto can only send 4 telegrams every PLC cycle.

Note: Additional data can be sent with time interval up to **300 ms** as the internal timeout is fixed to 1000 ms. For example can the time interval be set by using timer block TON, see example below, which then will to lower the bus load if this update time is appropriate for the application.

12.3.2.3 Example of usage in Pluto program

The following two examples show how transmission rate can be controlled in order to limit the CAN bus load and program execution time in Pluto.

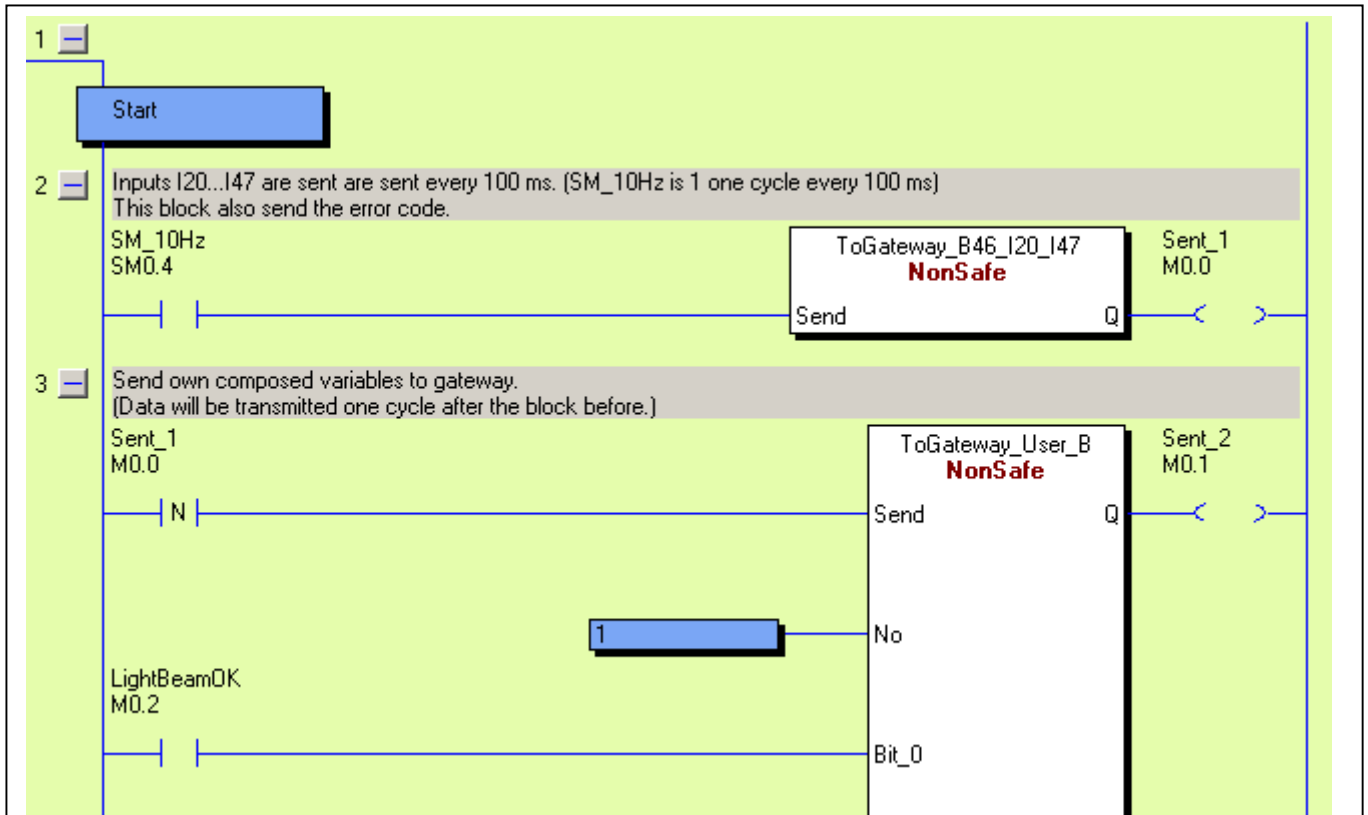

Figure 93 – Example 1: Transmission of local IO:s in a Pluto B46 user defined block. The input “Send” in the first block is connected to the system memory for 10Hz to decrease the CAN bus load to 1 telegram / 100ms. The second block will be transmitted one PLC cycle after the first because “Send” is connected to negative edge of Sent_1.”.

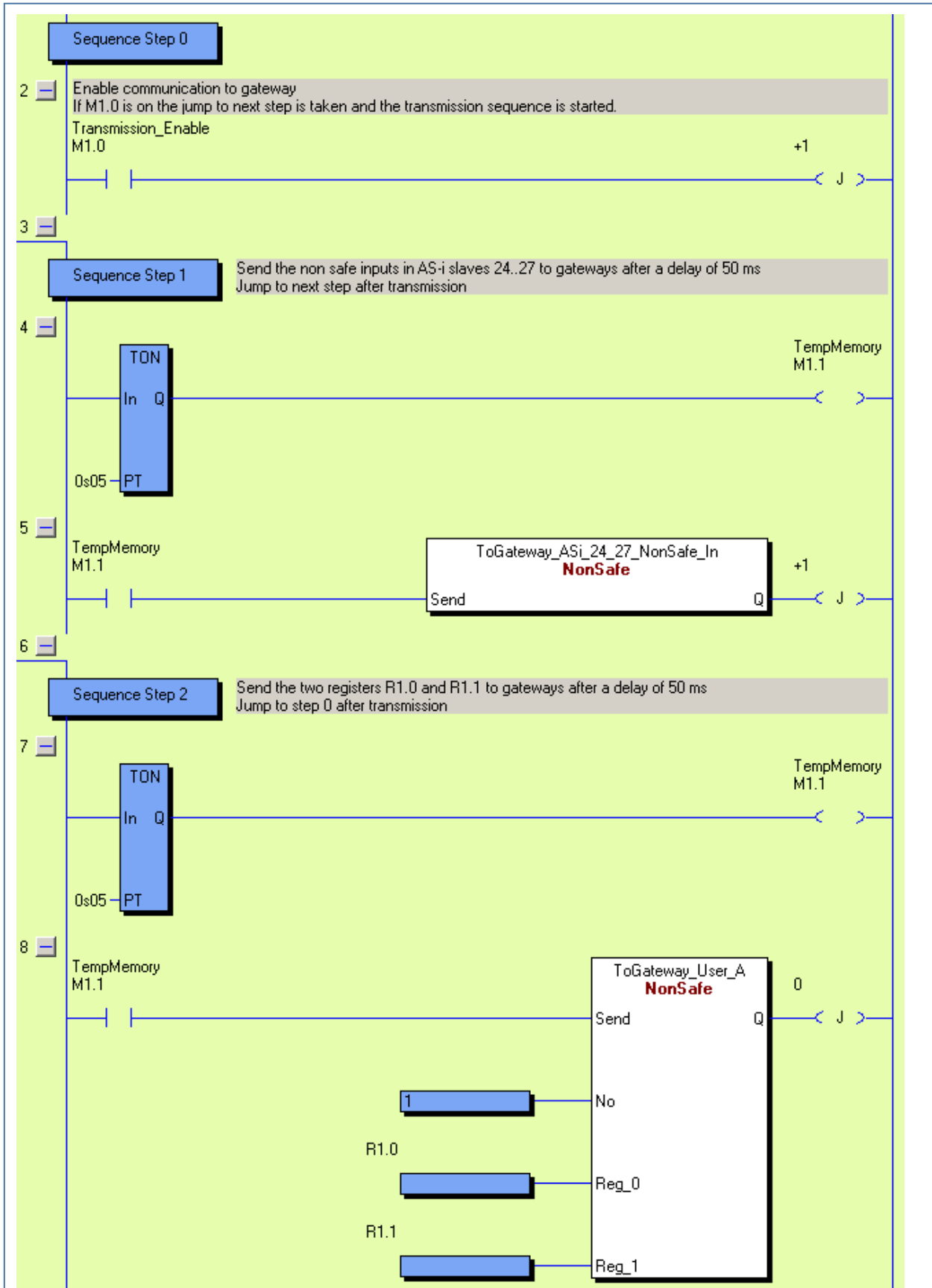

Figure 94 – Example for transmission from a Pluto AS-i sequence. The transmission can be enabled by memory M0.0 in sequence 0 then a telegram will be transmitted every 50 ms. This is a recommended method when a lot of blocks are used since it limits the CAN bus load and the Pluto do not need to execute the code in inactive sequence steps.

12.4 Data to Pluto

A gateway can totally transfer 64 bit variables and 8 registers from other field buses to the Pluto bus. The area “Data to Pluto” is divided into four packets each with 16 bit variables and two registers and is organized according to the table below.

To Pluto Area Packet	Type	Data
0	Bit (16 bits)	Bit variables 0...15
	Register (16 bits)	Register 0
	Register (16 bits)	Register 1
1	Bit (16 bits)	Bit variables 0...15
	Register (16 bits)	Register 0
	Register (16 bits)	Register 1
2	Bit (16 bits)	Bit variables 0...15
	Register (16 bits)	Register 0
	Register (16 bits)	Register 1
3	Bit (16 bits)	Bit variables 0...15
	Register (16 bits)	Register 0
	Register (16 bits)	Register 1

Table 56, “Data to Pluto” data allocation.

12.4.1 Enable bit

A PLC system on the field bus can enable the usage of 0 to 4 of the packets for Data to Pluto, for example enable the gateway to transfer the data in packet 0 and 1 to the units on the Pluto bus. The gateway then transmits one packet in one CAN telegram.

12.4.2 Cyclic transmission time

The gateway will transmit each data packet cyclically every 100 ms to the Pluto bus. The time interval is 4 – 255 ms with a default value of 100 ms.

Note: Low cycle time will load the Pluto bus more. Therefore this value shall not be set lower than needed and with consideration of the load of the Pluto bus.

12.4.3 Timeout time

A PLC system on the field bus can also set a timeout value time in the range of 0 – 60000 ms. The default value is **0** which is the same as **no timeout**. If the gateway does not receive data telegrams from the field bus within the timeout time the data will be cleared and the gateway will transmit “0”.

12.5 In PLUTO - Reception of external data from gateway

A PLUTO has a corresponding data area for external communication divided in four data blocks which enables each PLUTO unit to receive four packets of data from different sources e.g. four different gateways. A data block in a PLUTO is programmed to receive data from a certain gateway node number (0 – 15) and a certain packet number (0 – 15).

12.5.1 Set up in PLUTO for reception

For each PLUTO which shall receive data from a gateway, a setup must be made to decide from where the data comes. If the same gateway shall send to more than one block it must send in two different packets. (One packet is one CAN telegram).

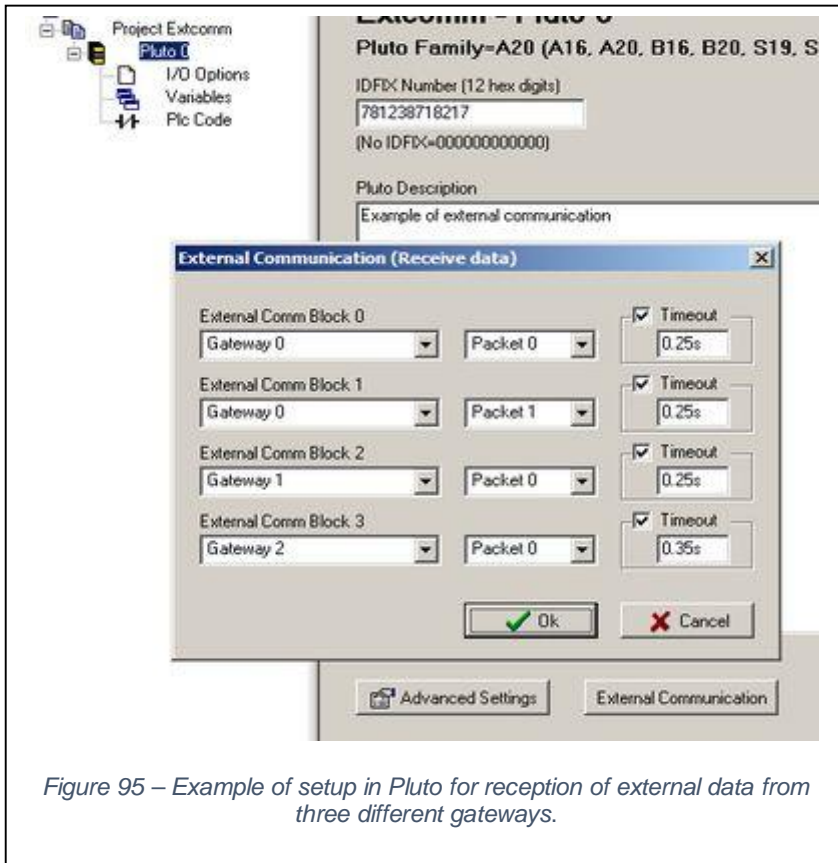

Figure 95 – Example of setup in Pluto for reception of external data from three different gateways.

Note: The timeout shall be greater than the gateway cycle time which has a default value of 100 ms, see chapter 12.4.2.

12.5.2 Addressing of external data in Pluto

In the PLUTO the variables are numbered according to the following table.

Data block	Data in Pluto
External Comm Block 0	Data bit 0...15
	Register 0
	Register 1
External Comm Block 1	Data bit 16...31
	Register 2
	Register 3
External Comm Block 2	Data bit 32...47
	Register 4
	Register 5
External Comm Block 3	Data bit 48...63
	Register 6
	Register 7

Table 57, "Data to Pluto" external data in Pluto.

12.5.3 Connection of external variables in PLC code

When the setup in “External Communication” is made the data can be used in the PLC code. Then there are function blocks for linking the variables to the ordinary PLC variables M, Q, GM or R. The blocks are available in the library “Ext01.fps” which must be selected.

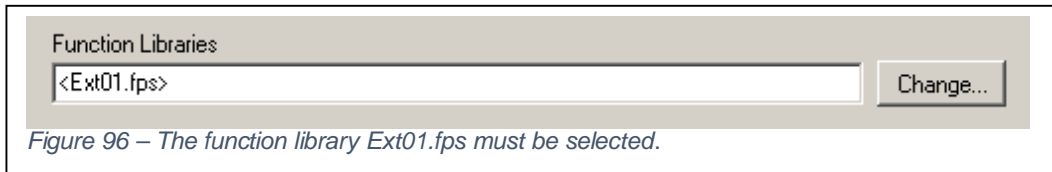

12.5.3.1 Function block "Ext_Sig"

The function block Ext_Sig links the data bits to the PLC code.

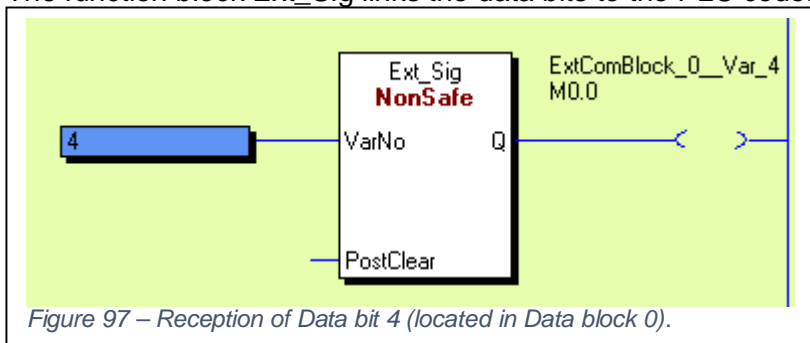

12.5.3.2 Function block "Ext_Val"

The function block Ext_Val links the registers to the PLC code.

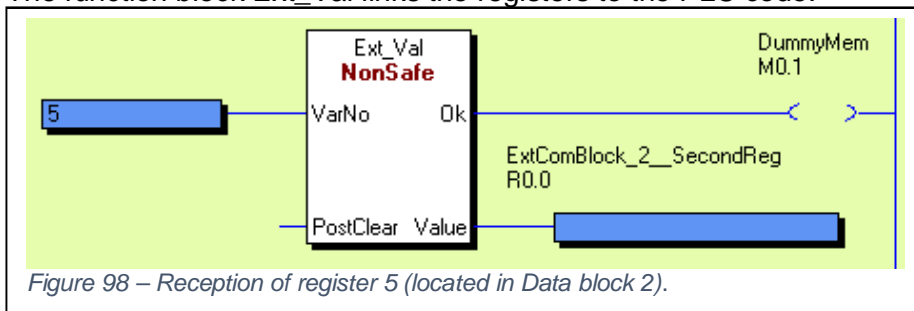

12.5.3.3 Function block "ExtVarBlock"

The function block ExtVarBlock makes it possible to link all variables in one of the “External comm blocks” to the PLC code. The function block is very big but is easier to use since the only input parameter is the number of the “External comm. Block”.

- By setting of BlockNo = 0: Bits 0...15 and Reg 0..1 are given.
 - By setting of BlockNo = 1: Bits 16...31 and Reg 2..3 are given.
 - By setting of BlockNo = 2: Bits 32...47 and Reg 4..5 are given.
 - By setting of BlockNo = 3: Bits 48...63 and Reg 6..7 are given.
- (According to table 12.5.2)

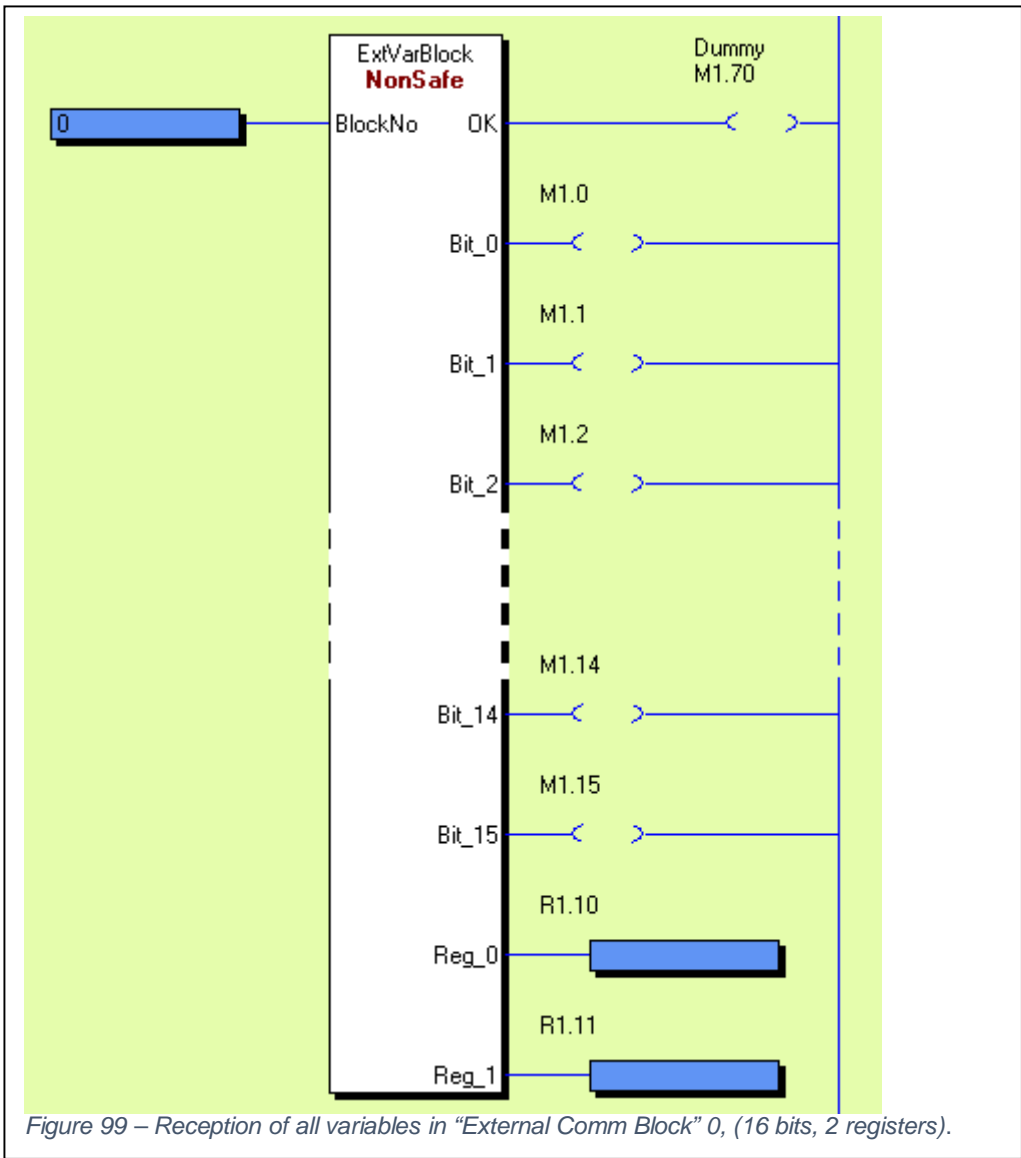



Figure 99 – Reception of all variables in “External Comm Block” 0, (16 bits, 2 registers).

13 Technical data

13.1 Protocol specific data

GATE-EIP – EtherNet/IP	
Interface	According to, <ul style="list-style-type: none"> · ODVA, CIP Volume 1 Edition 3.16 · ODVA, CIP Volume 2 EtherNet/IP Adaption of CIP Edition 1.17 · Minimum RPI value of 10 ms.
Status indication	Mod (Module) status and Net (Network) status.
Default IP address	DHCP.
Service ports	TCP/44818, UDP/2222 and UDP/44818 (see 7.4).
GATE-EC – EtherCAT	
Interface	According to <ul style="list-style-type: none"> · IEC 61158 Part 2-6 Type 12 documents (ETG.1000 V1.0.3). · EtherCAT Protocol Enhancements (ETG.1020 V1.0.0). · Minimum cycle time is 500 µs. · The device support FoE (firmware update). · The device support EoE (remote server).
Status indication	Run and Error status.
Default IP address	Master configured.
Service ports	-
GATE-S3 – Sercos III	
Interface	According to: <ul style="list-style-type: none"> · Communication Spec. V1.1.2.1.7 (March 30, 2009). · Sercos Communication Profile V1.1.2.1.1 (March 31, 2009). · Function Specific Profile IO V1.1.2.1.4 (May 11, 2009). · Internet Protocol Services V1.3.1 - 1.2 (February 10, 2011). · Minimum cycle time is 500 µs.
Status indication	S3 status.
Default IP address	192.168.0.100
Service ports	UDP/35021 (see 9.4).
GATE-PN – PROFINET	
Interface	According to: <ul style="list-style-type: none"> · Specification for PROFINET, Version 2.31. · IRT Top (“Red phase”) will be supported. · Minimum cycle time 2ms for RTC1 and 1ms for RTC3.
Status indication	SF (System Failure) and BF (Bus Failure).
Default IP address	Master configured.
Service ports	UDP/161, UDP/34964 and UDP/49152 (see 10.6).
GATE-MT – Modbus TCP	
Interface	According to: <ul style="list-style-type: none"> · Modbus Application Protocol Specification, V1.1a. · Modbus Messaging on TCP/IP Implementation Guide, V1.0a. · Minimum 500 request per seconds for one steady open connection with about 1 ms response time. · Maximum of 8 client connections.
Status indication	RUN (Connection) and ERR (Error).
Default IP address	DHCP.
Service ports	TCP/502 (see 11.4).

13.2 Common data

Ethernet data and services	
Interface	2 port with 10/100 Mbit/s, half/full duplex.
Status	Link status and traffic status on each port.
IP address	Static, DHCP and BOOTP. Set via terminal (PC port), not for GATE-EC and GATE-PN.
Remote server	Remote access (port 50100, changeable).
Pluto bus	
Pluto bus	CAN (electrical insulation 500 VAC).
Pluto bus speed	100, 125, 200, 250, 400, 500, 800 and 1000 kbit/s (automatic speed detection).
Status indication	Pluto bus status vid LED (Pluto bus).
PC port (front connector)	
Setting	57600 bit/s, 8 bit data, 1 stop bit, no parity and no flow control.
Cable (serial)	Article number 2TLA020070R5600.
Cable (USB)	Article number 2TLA020070R5800.
Common data	
DC power	24 VDC, -15% to +20%.
Power consumption at 24V	< 4.8 W < 0.2 A (recommended external fuse ≤ 6 A).
Electrical insulation	500 VAC for Pluto bus and Ethernet ports to DC power.
Enclosure	Width = 22.5 mm, height = 108 mm and depth = 114 mm.
Mounting	35 mm DIN rail.
Ambient air temperature	-10 °C to + 55 °C.
Temperature, transportation and storage	-25 °C to + 55 °C.
Operating altitude	Up to 2000 meter.
Humidity	EN 60 204-1 50% at 40 °C (ex 90% at 20 °C).
Degree of protection	Enclosure IP 20 - IEC 60 529. Terminals IP 20 - IEC 60 529.
Approval	

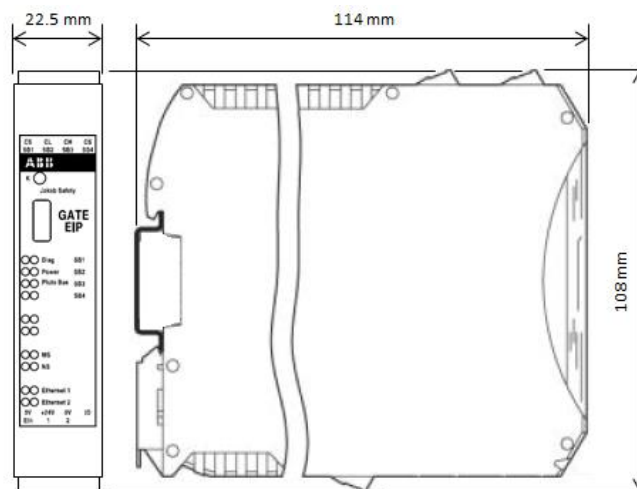

Figure 100 – Gateway mechanical dimensions.

14 Appendix A, gateway registers.

With the terminal command “gw” and via Pluto bus request it’s possible to read this information from the gateway. All gateway registers are 32-bit registers.

14.1 Gateway registers 0 - ...

Unit information registers.

Register	Data	Read	Write	Note
0	Unit firmware version - Bit 0 – 7, major number - Bit 8 – 15, minor number - Bit 16 – 23, build number - Bit 24 – 31, revision number	X		
1	Unit firmware date - Bit 0 – 7, century - Bit 8 – 15, year - Bit 16 – 23, month - Bit 24 – 31, day	X		
2	Reserved	-		
3	Reserved	-		
4	Reserved	-		
5	Unit name - GATE-EIP, 0x504945 (ASCII “PIE”) - GATE-EC, 0x4345 (ASCII “CE”) - GATE-S3, 0x3353 (ASCII “3S”) - GATE-PN, 0x4E50 (ASCII “NP”) - GATE-MT, 0x544D (ASCII “TM”)	X		
6	Unit device type - GATE-EIP, 0x8200 - GATE-EC, 0x8300 - GATE-S3, 0x8400 - GATE-PN, 0x8500 - GATE-MT, 0x8600	X		
7	Reserved	-		
8	Unit serial number	X		
9	Option information: - bit 0 set if support for pl/pkl commands.	X		
10	Unit uptime in seconds	X		
11	Unit gateway node number (0 – 15)	X		
12	Online Pluto bit mask information. - Bit 0 is Pluto 0 - Bit 1 is Pluto 1 - ... - Bit 31 is Pluto 31	X		
13	Active additional data bit mask information. - Bit 0 is additional area 0 - Bit 1 is additional area 1 - ... - Bit 31 is additional area 31	X		
14	-			
15	-			
16	-			
17	-			
18	-			

19	-			
20	CAN speed (0 = speed detection)	X		
21	CAN receive overrun counter	X		
22	CAN error status	X		
23	CAN error passive counter	X		
24	CAN bus off counter	X		
25	CAN restart counter	X		
26	CAN RX counter (CAN controller)	X		
27	CAN TX counter (CAN controller)	X		

14.2 Gateway registers 100 - ...

Fieldbus information registers.

Register	Data	Read	Write	Note
100	MAC address (high part, bit 0 - 15)	X		
101	MAC address (low part, bit 0 - 31)	X		
102	TCP/IP address <ul style="list-style-type: none"> - aaa.bbb.ccc.ddd - bit 24 – 32 is aaa value - bit 16 – 23 is bbb value - bit 8 – 15 is ccc value - bit 0 – 7 is ddd value 	X		
103	TCP/IP subnet mask <ul style="list-style-type: none"> - See coding for register 102 	X		
104	TCP/IP gateway address <ul style="list-style-type: none"> - See coding for register 102 	X		
105	TCP/IP address mode <ul style="list-style-type: none"> - 1 address mode Static - 2 address mode BOOTP - 3 address mode DHCP 	X		
106	Number of Ethernet ports	X		
107	Port speed for port 1 <ul style="list-style-type: none"> - 1 is 10 Mbit/s - 2 is 100 Mbit/s - Else undefined 	X		
108	Port speed for port 2 <ul style="list-style-type: none"> - See coding for register 107 	X		
109	Port speed for port 3 <ul style="list-style-type: none"> - See coding for register 107 	X		
110	Port speed for port 4 <ul style="list-style-type: none"> - See coding for register 107 	X		
111	Duplex information for port 1 <ul style="list-style-type: none"> - 1 is half duplex - 2 is full duplex - Else undefined 	X		
112	Duplex information for port 2 <ul style="list-style-type: none"> - See coding for register 111 	X		
113	Duplex information for port 3 <ul style="list-style-type: none"> - See coding for register 111 	X		
114	Duplex information for port 4 <ul style="list-style-type: none"> - See coding for register 111 	X		
115	MAC address for port 1 (high part, bit 0 - 15)	X		GATE-PN
116	MAC address for port 1 (low part, bit 0 - 31)	X		GATE-PN

117	MAC address for port 2 (high part, bit 0 - 15)	X		GATE-PN
118	MAC address for port 2 (low part, bit 0 - 31)	X		GATE-PN
119	MAC address for port 3 (high part, bit 0 - 15)	X		GATE-PN
120	MAC address for port 3 (low part, bit 0 - 31)	X		GATE-PN
121	MAC address for port 4 (high part, bit 0 - 15)	X		GATE-PN
122	MAC address for port 4 (low part, bit 0 - 31)	X		GATE-PN
123	Remote server active - 1 is active / 0 is not active	X		
124	Remote server port number	X		
125	Remote Pluto system control - 1 is active / 0 is not active	X		
125	Number of connections to remote server	X		
127	Max number of connections to remote server	X		

GATE-EIP specific registers (EtherNet/IP).

150	Vendor id	X		
151	Product number	X		
152	Profile number	X		
153	Module status	X		
154	Network status	X		

GATE-EC specific registers (EtherCAT).

150	Vendor id	X		
151	Product number	X		

GATE-S3 specific registers (Sercos III).

150	Vendor id	X		
151	Product number	X		

GATE-PN specific registers (PROFINET).

150	Vendor id	X		
151	Product number	X		

GATE-MT specific registers (Modbus TCP).

150	-	-		
-----	---	---	--	--

14.3 Gateway register 200 - ...

Pluto global data register information.

Register	Data	Read	Write	Note
200	Global data from Pluto 0	X		
201	Global data from Pluto 1	X		
202	Global data from Pluto 2	X		
203	Global data from Pluto 3	X		
204	Global data from Pluto 4	X		
205	Global data from Pluto 5	X		
206	Global data from Pluto 6	X		
207	Global data from Pluto 7	X		

208	Global data from Pluto 8	X		
209	Global data from Pluto 9	X		
210	Global data from Pluto 10	X		
211	Global data from Pluto 11	X		
212	Global data from Pluto 12	X		
213	Global data from Pluto 13	X		
214	Global data from Pluto 14	X		
215	Global data from Pluto 15	X		
216	Global data from Pluto 16	X		
217	Global data from Pluto 17	X		
218	Global data from Pluto 18	X		
219	Global data from Pluto 19	X		
220	Global data from Pluto 20	X		
221	Global data from Pluto 21	X		
222	Global data from Pluto 22	X		
223	Global data from Pluto 23	X		
224	Global data from Pluto 24	X		
225	Global data from Pluto 25	X		
226	Global data from Pluto 26	X		
227	Global data from Pluto 27	X		
228	Global data from Pluto 28	X		
229	Global data from Pluto 29	X		
230	Global data from Pluto 30	X		
231	Global data from Pluto 31	X		

14.4 Gateway register 300 - ...

Additional data register information.

Register	Data	Read	Write	Note
300	Additional data for area 0	X		
301	Additional data for area 1	X		
302	Additional data for area 2	X		
303	Additional data for area 3	X		
304	Additional data for area 4	X		
305	Additional data for area 5	X		
306	Additional data for area 6	X		
307	Additional data for area 7	X		
308	Additional data for area 8	X		
309	Additional data for area 9	X		
310	Additional data for area 10	X		
311	Additional data for area 11	X		
312	Additional data for area 12	X		
313	Additional data for area 13	X		
314	Additional data for area 14	X		
315	Additional data for area 15	X		
316	Additional data for area 16	X		
317	Additional data for area 17	X		
318	Additional data for area 18	X		
319	Additional data for area 19	X		
320	Additional data for area 20	X		
321	Additional data for area 21	X		
322	Additional data for area 22	X		
323	Additional data for area 23	X		
324	Additional data for area 24	X		

325	Additional data for area 25	X		
326	Additional data for area 26	X		
327	Additional data for area 27	X		
328	Additional data for area 28	X		
329	Additional data for area 29	X		
330	Additional data for area 30	X		
331	Additional data for area 31	X		

14.5 Gateway register 400 - ...

Additional filter register information.

- Bit 0 – 7 coding IO-type
- Bit 8 – 15 coding Pluto number
- Bit 30 set if active on Pluto bus
- Bit 31 set if configuration active (e.g. IO-type not zero)

Register	Data	Read	Write	Note
400	Additional filter for area 0	X		
401	Additional filter for area 1	X		
402	Additional filter for area 2	X		
403	Additional filter for area 3	X		
404	Additional filter for area 4	X		
405	Additional filter for area 5	X		
406	Additional filter for area 6	X		
407	Additional filter for area 7	X		
408	Additional filter for area 8	X		
409	Additional filter for area 9	X		
410	Additional filter for area 10	X		
411	Additional filter for area 11	X		
412	Additional filter for area 12	X		
413	Additional filter for area 13	X		
414	Additional filter for area 14	X		
415	Additional filter for area 15	X		
416	Additional filter for area 16	X		
417	Additional filter for area 17	X		
418	Additional filter for area 18	X		
419	Additional filter for area 19	X		
420	Additional filter for area 20	X		
421	Additional filter for area 21	X		
422	Additional filter for area 22	X		
423	Additional filter for area 23	X		
424	Additional filter for area 24	X		
425	Additional filter for area 25	X		
426	Additional filter for area 26	X		
427	Additional filter for area 27	X		
428	Additional filter for area 28	X		
429	Additional filter for area 29	X		
430	Additional filter for area 30	X		
431	Additional filter for area 31	X		

14.6 Gateway register 500 - ...

Data to Pluto data register information.

Register	Data	Read	Write	Note
500	Data to Pluto area 0, bits	X		
501	Data to Pluto area 0, register 1	X		
502	Data to Pluto area 0, register 2	X		
503	Data to Pluto area 1, bits	X		
504	Data to Pluto area 1, register 1	X		
505	Data to Pluto area 1, register 2	X		
506	Data to Pluto area 2, bits	X		
507	Data to Pluto area 2, register 1	X		
508	Data to Pluto area 2, register 2	X		
509	Data to Pluto area 3, bits	X		
510	Data to Pluto area 3, register 1	X		
511	Data to Pluto area 3, register 2	X		

14.7 Gateway register 600 - ...

Data to Pluto setting register information.

Register	Data	Read	Write	Note
600	Data to Pluto enable bit mask <ul style="list-style-type: none"> - Bit 0 enable area 0 - Bit 1 enable area 1 - Bit 2 enable area 2 - Bit 3 enable area 2 	X		
601	Data to Pluto update time (ms)	X		
602	Data to Pluto timeout (ms)	X		

15 Appendix B, object description EtherNet/IP

This is a description of the object model used for EtherNet/IP.

15.1 Definitions

The following table has a description of all of the data types used.

USINT	Unsigned Short Integer (8-bit)
UINT	Unsigned Integer (16-bit)
UDINT	Unsigned Double Integer (32-bit)
STRING	Character String (1 byte per character)
BYTE	Bit String (8-bits)
WORD	Bit String (16-bits)
DWORD	Bit String (32-bits)

15.2 Identity Object (01_{HEX} - 1 Instance)

Class Attributes

Attribute ID	Name	Data Type	Data Value	Access Rule
1	Revision	UINT	1	Get

Instance Attributes

Attribute ID	Name	Data Type	Data Value	Access Rule
1	Vendor Number	UINT	950	Get
2	Device Type	UINT	43	Get
3	Product Code Number	UINT	1100	Get
4	Product Major Revision Product Minor Revision	USINT USINT	2 11	Get
5	Status Word (see below for definition)	WORD	See Below	Get
6	Product Serial Number	UDINT	Unique 32 Bit Value	Get
7	Product Name	String of USINT	GATE-EIP	Get

Status Word

Bit	Bit = 0	Bit = 1
0	Not Owned	Owned
1	Unused	Unused
2	No configuration since the last Out of Box reset.	The device has been configured since the last Out of Box reset.
3 – 15	Unused	Unused

Common Services

Service Code	Implemented for		Service Name
	Class Level	Instance Level	
0E _{HEX}	Yes	Yes	Get_Attribute_Single
05 _{HEX}	No	Yes	Reset

15.3 Message Router Object (02_{HEX})

This object has no supported attributes.

15.4 Assembly Object (04_{HEX} – 5 Instances)

Class Attributes (Instance 0)

Attribute ID	Name	Data Type	Data Value	Access Rule
1	Revision	UINT	2	Get
2	Max Instance	UINT	113	Get

Input Instance Attributes (Instance 100 - 102)

Attribute ID	Name	Data Type	Default Data Value	Access Rule
3	Input Data	USINT [4-132]	0	Get

Input Instance 100 – 4 Bytes (Node Status Only)

For more information about data structure see chapter 12.

Bytes	Class, Instance, Attribute	Description
0 – 3	0x64, 0x00, 0B	Node Status

Input Instance 101 – 256 Bytes (Node Data Only)

For more information about data structure see chapter 12.

Bytes	Class, Instance, Attribute	Description
0 – 3	0x64, 0x01, 0x04	Combined 32 Bit Data – Node 0
4 – 7	0x64, 0x02, 0x04	Combined 32 Bit Data – Node 1
...		
120 – 123	0x64, 0x1F, 0x04	Combined 32 Bit Data – Node 30
124 – 127	0x64, 0x20, 0x04	Combined 32 Bit Data – Node 31
128 – 131	0x64, 0x01, 0x0A	Additional Data 00
132 – 135	0x64, 0x02, 0x0A	Additional Data 01
...		
248 – 251	0x64, 0x1F, 0x0A	Additional Data 30
252 – 255	0x64, 0x20, 0x0A	Additional Data 31

Input Instance 102 – 260 Bytes (Node Status and Data)

For more information about data structure see chapter 12.

Bytes	Class, Instance, Attribute	Description
0 – 3	0x64, 0x00, 0x0B	Node Status
4 – 7	0x64, 0x01, 0x04	Combined 32 Bit Data – Node 0
8 – 11	0x64, 0x02, 0x04	Combined 32 Bit Data – Node 1
...		
124 – 127	0x64, 0x1F, 0x04	Combined 32 Bit Data – Node 30
128 – 131	0x64, 0x20, 0x04	Combined 32 Bit Data – Node 31
132 – 135	0x64, 0x01, 0x0A	Additional Data 00
136 – 139	0x64, 0x02, 0x0A	Additional Data 01
...		
252 – 255	0x64, 0x1F, 0x0A	Additional Data 30
256 – 259	0x64, 0x20, 0x0A	Additional Data 31

Output Instance Attributes (Instance 112)

Attribute ID	Name	Data Type	Default Data Value	Access Rule
3	Output Data	USINT [0-24]	0	Get

Output Instance 112 – 24 Bytes (Data to Pluto)

For more information about data structure see chapter **Error! Reference source not found..**

Bytes	Class, Instance, Attribute	Description
0 – 5	0x64, 0x00, 0x0C	Data to Pluto area 0
6 – 11	0x64, 0x00, 0x0D	Data to Pluto area 1
12 – 17	0x64, 0x00, 0x0E	Data to Pluto area 2
18 – 23	0x64, 0x00, 0x0F	Data to Pluto area 3

Output Instance 128 (Heartbeat Instance – Input Only)

This instance allows client to monitor input data without providing output data.

Output Instance 129 (Heartbeat Instance – Listen Only)

This instance allows client to monitor input data without providing output data. To utilize this connection type, an owning connection must exist from a second client and the configuration of the connection must match exactly.

Output Instance 130 (Configuration Instance)

This instance allows client to download necessary configuration information to the gateway when the I/O connection is opened. The configuration instance supports 0 – 400 bytes of data. If no configuration data is needed this instance may be omitted.

Common Services

Service Code	Implemented for		Service Name
	Class Level	Instance Level	
0E _{HEX}	Yes	Yes	Get_Attribute_Single
10 _{HEX}	No	Yes	Set_Attribute_Single

15.5 Connection Manager Object (06_{HEX})

This object has no attributes.

15.6 TCP Object (F5_{HEX} - 1 Instance)

Class Attributes

Attribute ID	Name	Data Type	Data Value	Access Rule
1	Revision	UINT	1	Get

Instance Attributes

Attribute ID	Name	Data Type	Default Data Value	Access Rule
1	Status ¹	DWORD	1	Get
2	Configuration Capability ²	DWORD	0	Get
3	Configuration Control ³	DWORD	0	Get
4	Physical Link Object ⁴ Structure of: Path Size Path	UINT Array Of WORD	2 0x20F6 0x2401	Get
5	Interface Configuration ⁵ Structure of: IP Address Network Mask Gateway Address Name Server Name Server 2 Domain Name Size Domain Name	UDINT UDINT UDINT UDINT UDINT UINT STRING	0 0 0 0 0 0 0	Get
6	Host Name ⁶ Structure of: Host Name Size Host Name	UINT STRING	0 0	Get

Common Services

Service Code	Implemented for		Service Name
	Class Level	Instance Level	
0E _{HEX}	Yes	Yes	Get_Attribute_Single
10 _{HEX}	No	Yes	Set_Attribute_Single
01 _{HEX}	No	Yes	Get_Attribute_All

¹ See section 5-3.2.2.1 of "Volume 2: EtherNet/IP Adaptation of CIP" from ODVA for more details on this attribute.

² See section 5-3.2.2.2 of "Volume 2: EtherNet/IP Adaptation of CIP" from ODVA for more details on this attribute.

³ See section 5-3.2.2.3 of "Volume 2: EtherNet/IP Adaptation of CIP" from ODVA for more details on this attribute.

⁴ See section 5-3.2.2.4 of "Volume 2: EtherNet/IP Adaptation of CIP" from ODVA for more details on this attribute.

⁵ See section 5-3.2.2.5 of "Volume 2: EtherNet/IP Adaptation of CIP" from ODVA for more details on this attribute.

⁶ See section 5-3.2.2.6 of "Volume 2: EtherNet/IP Adaptation of CIP" from ODVA for more details on this attribute.

15.7 Ethernet Link Object (F6_{HEX} - 1 Instance)

Class Attributes

Attribute ID	Name	Data Type	Data Value	Access Rule
1	Revision	UINT	1	Get

Instance Attributes

Attribute ID	Name	Data Type	Default Data Value	Access Rule
1	Interface Speed ⁷	UDINT	100	Get
2	Interface Flags ⁸	DWORD	3	Get
3	Physical Address ⁹	USINT Array[6]	0	Get

Common Services

Service Code	Implemented for		Service Name
	Class Level	Instance Level	
0E _{HEX}	Yes	Yes	Get_Attribute_Single
01 _{HEX}	No	Yes	Get_Attribute_All

⁷ See section 5-4.2.2.1 of "Volume 2: EtherNet/IP Adaptation of CIP" from ODVA for more details on this attribute.

⁸ See section 5-4.2.2.2 of "Volume 2: EtherNet/IP Adaptation of CIP" from ODVA for more details on this attribute.

⁹ See section 5-4.2.2.3 of "Volume 2: EtherNet/IP Adaptation of CIP" from ODVA for more details on this attribute.

15.8 Application Object (64_{HEX} - 32 Instances)

Class Attributes (Instance 0)

For more information about “Data to Pluto” structure see chapter 12.4.

Attribute ID	Name	Data Type	Default Data Value	Access Rule
1	Revision	UINT	1	Get
10	Expected Nodes Bitmap Not used!	DWORD	0	Get/Set
11	Node Status Bitmap	DWORD	0	Get
12	Data to Pluto 1	UINT[3]	0,0,0	Get/Set
13	Data to Pluto 2	UINT[3]	0,0,0	Get/Set
14	Data to Pluto 3	UINT[3]	0,0,0	Get/Set
15	Data to Pluto 4	UINT[3]	0,0,0	Get/Set
16	Enable Data to Pluto (0 = Disabled; 1 = Enabled) Bit 0 – Data To Pluto 1 Bit 1 – Data To Pluto 2 Bit 2 – Data To Pluto 3 Bit 3 – Data To Pluto 4	BYTE	0	Get/Set
17	Data to Pluto Timeout (ms) 0 = timeout disabled Valid value ≥ 1000 ms.	UINT16	0	Get/Set
18	Data to Pluto Update Time (ms). Value modulus of 4 e.g. 0, 4, 8, 16... 252.	UINT8	100	Get/Set
19	Set gateway node number 0 = DIP switch setting 1 = Node number 0 2 = Node number 1 ... 16 = Node number 15	UINT8	0	Get/Set
20	Read gateway node number 0 = Node number 0 1 = Node number 1 ... 15 = Node number 15	UINT8	0	Get

Additional data configuration see chapter 12.3.

Attribute ID	Name	Data Type	Default Data Value	Access Rule
32	Additional Data 00, Node (0-31)	BYTE	0	Get/Set
33	Additional Data 00, IO-type	BYTE	0	Get/Set
34	Additional Data 01, Node (0-31)	BYTE	0	Get/Set
35	Additional Data 01, IO-type	BYTE	0	Get/Set
36	Additional Data 02, Node (0-31)	BYTE	0	Get/Set
37	Additional Data 02, IO-type	BYTE	0	Get/Set
38	Additional Data 03, Node (0-31)	BYTE	0	Get/Set
39	Additional Data 03, IO-type	BYTE	0	Get/Set
40	Additional Data 04, Node (0-31)	BYTE	0	Get/Set
41	Additional Data 04, IO-type	BYTE	0	Get/Set
42	Additional Data 05, Node (0-31)	BYTE	0	Get/Set
43	Additional Data 05, IO-type	BYTE	0	Get/Set

44	Additional Data 06, Node (0-31)	BYTE	0	Get/Set
45	Additional Data 06, IO-type	BYTE	0	Get/Set
46	Additional Data 07, Node (0-31)	BYTE	0	Get/Set
47	Additional Data 07, IO-type	BYTE	0	Get/Set
48	Additional Data 08, Node (0-31)	BYTE	0	Get/Set
49	Additional Data 08, IO-type	BYTE	0	Get/Set
50	Additional Data 09, Node (0-31)	BYTE	0	Get/Set
51	Additional Data 09, IO-type	BYTE	0	Get/Set
52	Additional Data 10, Node (0-31)	BYTE	0	Get/Set
53	Additional Data 10, IO-type	BYTE	0	Get/Set
54	Additional Data 11, Node (0-31)	BYTE	0	Get/Set
55	Additional Data 11, IO-type	BYTE	0	Get/Set
56	Additional Data 12, Node (0-31)	BYTE	0	Get/Set
57	Additional Data 12, IO-type	BYTE	0	Get/Set
58	Additional Data 13, Node (0-31)	BYTE	0	Get/Set
59	Additional Data 13, IO-type	BYTE	0	Get/Set
60	Additional Data 14, Node (0-31)	BYTE	0	Get/Set
61	Additional Data 14, IO-type	BYTE	0	Get/Set
62	Additional Data 15, Node (0-31)	BYTE	0	Get/Set
63	Additional Data 15, IO-type	BYTE	0	Get/Set
64	Additional Data 16, Node (0-31)	BYTE	0	Get/Set
65	Additional Data 16, IO-type	BYTE	0	Get/Set
66	Additional Data 17, Node (0-31)	BYTE	0	Get/Set
67	Additional Data 17, IO-type	BYTE	0	Get/Set
68	Additional Data 18, Node (0-31)	BYTE	0	Get/Set
69	Additional Data 18, IO-type	BYTE	0	Get/Set
70	Additional Data 19, Node (0-31)	BYTE	0	Get/Set
71	Additional Data 19, IO-type	BYTE	0	Get/Set
72	Additional Data 20, Node (0-31)	BYTE	0	Get/Set
73	Additional Data 20, IO-type	BYTE	0	Get/Set
74	Additional Data 21, Node (0-31)	BYTE	0	Get/Set
75	Additional Data 21, IO-type	BYTE	0	Get/Set
76	Additional Data 22, Node (0-31)	BYTE	0	Get/Set
77	Additional Data 22, IO-type	BYTE	0	Get/Set
78	Additional Data 23, Node (0-31)	BYTE	0	Get/Set
79	Additional Data 23, IO-type	BYTE	0	Get/Set
80	Additional Data 24, Node (0-31)	BYTE	0	Get/Set
81	Additional Data 24, IO-type	BYTE	0	Get/Set
82	Additional Data 25, Node (0-31)	BYTE	0	Get/Set
83	Additional Data 25, IO-type	BYTE	0	Get/Set
84	Additional Data 26, Node (0-31)	BYTE	0	Get/Set
85	Additional Data 26, IO-type	BYTE	0	Get/Set
86	Additional Data 27, Node (0-31)	BYTE	0	Get/Set
87	Additional Data 27, IO-type	BYTE	0	Get/Set
88	Additional Data 28, Node (0-31)	BYTE	0	Get/Set
89	Additional Data 28, IO-type	BYTE	0	Get/Set
90	Additional Data 29, Node (0-31)	BYTE	0	Get/Set
91	Additional Data 29, IO-type	BYTE	0	Get/Set
92	Additional Data 30, Node (0-31)	BYTE	0	Get/Set
93	Additional Data 30, IO-type	BYTE	0	Get/Set
94	Additional Data 31, Node (0-31)	BYTE	0	Get/Set
95	Additional Data 31, IO-type	BYTE	0	Get/Set

Instance Attributes (Instances 1-32)

Instance value 1-32 is equal to Pluto station number 0-31.

Attribute ID	Name	Data Type	Default Data Value	Access Rule
1	Input Bits	WORD	0	Get
2	Output Bits	BYTE	0	Get
3	Global Bits	WORD	0	Get
4	Combined 32 Bits	DWORD	0	Get
10	Additional Data 32 Bits	DWORD	0	Get

Common Services

Service Code	Implemented for		Service Name
	Class Level	Instance Level	
0E _{HEX}	Yes	Yes	Get Attribute Single
10 _{HEX}	Yes	No	Set Attribute Single

16 Appendix C, object description EtherCAT

16.1 PDO mapping

16.1.1 Input mapping

16.1.1.1 Pluto status (0x1A00)

Index: Subindex	Name	Data Type	Default Data Value	Access
0x1A00:1	Pluto status data(0x2120:1)			

16.1.1.2 Pluto global 0 – 7 (0x1A01)

Index: Subindex	Name	Data Type	Default Data Value	Access
0x1A01:1	Pluto global 0 (0x2100:1)			
0x1A01:2	Pluto global 1 (0x2100:2)			
0x1A01:3	Pluto global 2 (0x2100:3)			
0x1A01:4	Pluto global 3 (0x2100:4)			
0x1A01:5	Pluto global 4 (0x2100:5)			
0x1A01:6	Pluto global 5 (0x2100:6)			
0x1A01:7	Pluto global 6 (0x2100:7)			
0x1A01:8	Pluto global 7 (0x2100:8)			

16.1.1.3 Pluto global 8 – 15 (0x1A02)

Index: Subindex	Name	Data Type	Default Data Value	Access
0x1A02:1	Pluto global 8 (0x2100:9)			
0x1A02:2	Pluto global 9 (0x2100:10)			
0x1A02:3	Pluto global 10 (0x2100:11)			
0x1A02:4	Pluto global 11 (0x2100:12)			
0x1A02:5	Pluto global 12 (0x2100:13)			
0x1A02:6	Pluto global 13 (0x2100:14)			
0x1A02:7	Pluto global 14 (0x2100:15)			
0x1A02:8	Pluto global 15 (0x2100:16)			

16.1.1.4 Pluto global 16 – 23 (0x1A03)

Index: Subindex	Name	Data Type	Default Data Value	Access
0x1A03:1	Pluto global 16 (0x2100:17)			
0x1A03:2	Pluto global 17 (0x2100:18)			
0x1A03:3	Pluto global 18 (0x2100:19)			
0x1A03:4	Pluto global 19 (0x2100:20)			

Index: Subindex	Name	Data Type	Default Data Value	Access
0x1A03:5	Pluto global 20 (0x2100:21)			
0x1A03:6	Pluto global 21 (0x2100:22)			
0x1A03:7	Pluto global 22 (0x2100:23)			
0x1A03:8	Pluto global 23 (0x2100:24)			

16.1.1.5 Pluto global 24 – 31 (0x1A04)

Index: Subindex	Name	Data Type	Default Data Value	Access
0x1A04:1	Pluto global 24 (0x2100:25)			
0x1A04:2	Pluto global 25 (0x2100:26)			
0x1A04:3	Pluto global 26 (0x2100:27)			
0x1A04:4	Pluto global 27 (0x2100:28)			
0x1A04:5	Pluto global 28 (0x2100:29)			
0x1A04:6	Pluto global 29 (0x2100:30)			
0x1A04:7	Pluto global 30 (0x2100:31)			
0x1A04:8	Pluto global 31 (0x2100:31)			

16.1.1.6 Additional data 0 – 7 (0x1A05)

Index: Subindex	Name	Data Type	Default Data Value	Access
0x1A05:1	Additional data 0 (0x2101:1)			
0x1A05:2	Additional data 1 (0x2101:2)			
0x1A05:3	Additional data 2 (0x2101:3)			
0x1A05:4	Additional data 3 (0x2101:4)			
0x1A05:5	Additional data 4 (0x2101:5)			
0x1A05:6	Additional data 5 (0x2101:6)			
0x1A05:7	Additional data 6 (0x2101:7)			
0x1A05:8	Additional data 7 (0x2101:8)			

16.1.1.7 Additional data 8 – 15 (0x1A06)

Index: Subindex	Name	Data Type	Default Data Value	Access
0x1A06:1	Additional data 8 (0x2101:9)			
0x1A06:2	Additional data 9 (0x2101:10)			
0x1A06:3	Additional data 10 (0x2101:11)			
0x1A06:4	Additional data 11 (0x2101:12)			
0x1A06:5	Additional data 12 (0x2101:13)			
0x1A06:6	Additional data 13 (0x2101:14)			
0x1A06:7	Additional data 14 (0x2101:15)			

Index: Subindex	Name	Data Type	Default Data Value	Access
0x1A06:8	Additional data 15 (0x2101:16)			

16.1.1.8 Additional data 16 – 23 (0x1A07)

Index: Subindex	Name	Data Type	Default Data Value	Access
0x1A07:1	Additional data 16 (0x2101:17)			
0x1A07:2	Additional data 17 (0x2101:18)			
0x1A07:3	Additional data 18 (0x2101:19)			
0x1A07:4	Additional data 19 (0x2101:20)			
0x1A07:5	Additional data 20 (0x2101:21)			
0x1A07:6	Additional data 21 (0x2101:22)			
0x1A07:7	Additional data 22 (0x2101:23)			
0x1A07:8	Additional data 23 (0x2101:24)			

16.1.1.9 Additional data 24 – 31 (0x1A08)

Index: Subindex	Name	Data Type	Default Data Value	Access
0x1A08:1	Additional data 24 (0x2101:25)			
0x1A08:2	Additional data 25 (0x2101:26)			
0x1A08:3	Additional data 26 (0x2101:27)			
0x1A08:4	Additional data 27 (0x2101:28)			
0x1A08:5	Additional data 28 (0x2101:29)			
0x1A08:6	Additional data 29 (0x2101:30)			
0x1A08:7	Additional data 30 (0x2101:31)			
0x1A08:8	Additional data 31 (0x2101:31)			

16.1.2 Output mapping

16.1.2.1 Data to Pluto packet 1 (0x1600)

Index: Subindex	Name	Data Type	Default Data Value	Access
0x1600:1	Bits 0-15 (0x2200:1)			
0x1600:2	Register 0 (0x2200:2)			
0x1600:3	Register 1 (0x2200:3)			

16.1.2.2 Data to Pluto packet 1 (0x1601)

Index: Subindex	Name	Data Type	Default Data Value	Access
0x1601:1	Bits 0-15 (0x2201:1)			

Index: Subindex	Name	Data Type	Default Data Value	Access
0x1601:2	Register 0 (0x2201:2)			
0x1601:3	Register 1 (0x2201:3)			

16.1.2.3 Data to Pluto packet 3 (0x1602)

Index: Subindex	Name	Data Type	Default Data Value	Access
0x1602:1	Bits 0-15 (0x2202:1)			
0x1602:2	Register 0 (0x2202:2)			
0x1602:3	Register 1 (0x2202:3)			

16.1.2.4 Data to Pluto packet 4 (0x1603)

Index: Subindex	Name	Data Type	Default Data Value	Access
0x1603:1	Bits 0-15 (0x2203:1)			
0x1603:2	Register 0 (0x2203:2)			
0x1603:3	Register 1 (0x2203:3)			

16.2 SDO mapping

16.2.1 Pluto global data (0x2100)

Index: Subindex	Name	Data Type	Default Data Value	Access
0x2100:1	Pluto 0	DWORD	0	Ro
0x2100:2	Pluto 1	DWORD	0	Ro
0x2100:3	Pluto 2	DWORD	0	Ro
0x2100:4	Pluto 3	DWORD	0	Ro
0x2100:5	Pluto 4	DWORD	0	Ro
0x2100:6	Pluto 5	DWORD	0	Ro
0x2100:7	Pluto 6	DWORD	0	Ro
0x2100:8	Pluto 7	DWORD	0	Ro
0x2100:9	Pluto 8	DWORD	0	Ro
0x2100:10	Pluto 9	DWORD	0	Ro
0x2100:11	Pluto 10	DWORD	0	Ro
0x2100:12	Pluto 11	DWORD	0	Ro
0x2100:13	Pluto 12	DWORD	0	Ro
0x2100:14	Pluto 13	DWORD	0	Ro
0x2100:15	Pluto 14	DWORD	0	Ro
0x2100:16	Pluto 15	DWORD	0	Ro
0x2100:17	Pluto 16	DWORD	0	Ro
0x2100:18	Pluto 17	DWORD	0	Ro
0x2100:19	Pluto 18	DWORD	0	Ro
0x2100:20	Pluto 19	DWORD	0	Ro

Index: Subindex	Name	Data Type	Default Data Value	Access
0x2100:21	Pluto 20	DWORD	0	Ro
0x2100:22	Pluto 21	DWORD	0	Ro
0x2100:23	Pluto 22	DWORD	0	Ro
0x2100:24	Pluto 23	DWORD	0	Ro
0x2100:25	Pluto 24	DWORD	0	Ro
0x2100:26	Pluto 25	DWORD	0	Ro
0x2100:27	Pluto 26	DWORD	0	Ro
0x2100:28	Pluto 27	DWORD	0	Ro
0x2100:29	Pluto 28	DWORD	0	Ro
0x2100:30	Pluto 29	DWORD	0	Ro
0x2100:31	Pluto 30	DWORD	0	Ro
0x2100:32	Pluto 31	DWORD	0	Ro

16.2.2 Additional data (0x2101)

Index: Subindex	Name	Data Type	Default Data Value	Access
0x2101:1	Additional area 0	DWORD	0	Ro
0x2101:2	Additional area 1	DWORD	0	Ro
0x2101:3	Additional area 2	DWORD	0	Ro
0x2101:4	Additional area 3	DWORD	0	Ro
0x2101:5	Additional area 4	DWORD	0	Ro
0x2101:6	Additional area 5	DWORD	0	Ro
0x2101:7	Additional area 6	DWORD	0	Ro
0x2101:8	Additional area 7	DWORD	0	Ro
0x2101:9	Additional area 8	DWORD	0	Ro
0x2101:10	Additional area 9	DWORD	0	Ro
0x2101:11	Additional area 10	DWORD	0	Ro
0x2101:12	Additional area 11	DWORD	0	Ro
0x2101:13	Additional area 12	DWORD	0	Ro
0x2101:14	Additional area 13	DWORD	0	Ro
0x2101:15	Additional area 14	DWORD	0	Ro
0x2101:16	Additional area 15	DWORD	0	Ro
0x2101:17	Additional area 16	DWORD	0	Ro
0x2101:18	Additional area 17	DWORD	0	Ro
0x2101:19	Additional area 18	DWORD	0	Ro
0x2101:20	Additional area 19	DWORD	0	Ro
0x2101:21	Additional area 20	DWORD	0	Ro
0x2101:22	Additional area 21	DWORD	0	Ro
0x2101:23	Additional area 22	DWORD	0	Ro
0x2101:24	Additional area 23	DWORD	0	Ro
0x2101:25	Additional area 24	DWORD	0	Ro
0x2101:26	Additional area 25	DWORD	0	Ro
0x2101:27	Additional area 26	DWORD	0	Ro
0x2101:28	Additional area 27	DWORD	0	Ro
0x2101:29	Additional area 28	DWORD	0	Ro

Index: Subindex	Name	Data Type	Default Data Value	Access
0x2101:30	Additional area 29	DWORD	0	Ro
0x2101:31	Additional area 30	DWORD	0	Ro
0x2101:32	Additional area 31	DWORD	0	Ro

16.2.3 Pluto status (0x2120)

Index: Subindex	Name	Data Type	Default Data Value	Access
0x2120	Pluto status data	DWORD	0	Ro

16.2.4 Data to Pluto (0x220y)

There are 4 objects with the Indexes 0x2200 to 0x2203 represents the output data going to Pluto.

Index: Subindex	Name	Data Type	Default Data Value	Access
0x220Y	Data to Pluto Output Pack Y			
0x220Y:1	Py Bits 0-15	WORD	0	RW
0x220Y:2	Py Register 0	WORD	0	RW
0x220Y:3	Py Register 1	WORD	0	RW

16.2.5 Configuration of additional data (0x23zz)

There are 32 objects with the Indexes 0x2300 to 0x231F represents Additional data configuration. The object is only writeable in PREOP mode.

Index: Subindex	Name	Data Type	Default Data Value	Access
0x23ZZ	Config. of additional data			
0x23ZZ:1	ADzz Pluto node	BYTE	0	RW
0x23ZZ:2	ADzz IO-Type	BYTE	0	RW

16.2.6 Configuration of Data to Pluto (0x2320)

Index: Subindex	Name	Data Type	Default Data Value	Access
0x2320	Configuration of data to Pluto			
0x2320:1	Data to Pluto enable	BYTE	1	RW
0x2320:2	Data to Pluto timeout	WORD	1000	RW
0x2320:3	Data to Pluto update time	BYTE	100	RW

16.2.7 Configuration gateway node number (0x2321)

Index: Subindex	Name	Data Type	Default Data Value	Access
0x2321	Gateway node number	BYTE	0	RW

17 Appendix D, object description Sercos III

17.1 Standard Sercos IDN supported by the gateway

IDN	Name	Value	Unit	comment
S-0-0014	Interface Status	-	-	
S-0-0017	IDN list of all operation data	-	-	
S-0-0021	IDN list of invalid operation data for CP2	-	-	
S-0-0022	IDN list of invalid operation data for CP3	-	-	
S-0-0025	IDN list of all procedure commands	-	-	
S-0-0095	Diagnostic message	-	-	
S-0-0099	Reset class 1 diagnostic (Process Command)	-	-	
S-0-0127	CP3 transition check (Process Command)	-	-	
S-0-0128	CP4 transition check (Process Command)	-	-	
S-0-0267	Password	-		
S-0-0279	IDN list of password protected data	-	-	
S-0-0390	Diagnostic number	-	-	
S-0-0398	IDN list of configurable real-time bits as producer	-	-	
S-0-0399	IDN list of configurable real-time bits as consumer	-	-	
S-0-1000	SCP type & version	-	-	
S-0-1002	Communication cycle time (tScyc)	-	us	
S-0-1003	Allowed MST losses in CP3/CP4	10	-	
S-0-1005	Minimum feedback processing time (t5)	-	us	
S-0-1006	AT0 transmission starting time (t1)	-	us	
S-0-1007	Feedback acquisition capture point (t4)	-	us	
S-0-1008	Command value valid time (t3)	-	us	
S-0-1009	Device control (C-Dev) offset in MDT	-	-	
S-0-1010	Length of MDTs	-	-	
S-0-1011	Device status (S-Dev) offset in AT	-	-	
S-0-1012	Length of Ats	-	-	
S-0-1013	SVC offset in MDT	-	-	
S-0-1014	SVC offset in AT	-	-	
S-0-1015	Ring delay	-	us	
S-0-1016	Slave delay	-	us	
S-0-1017	NRT transmission time	-	us	
S-0-1019	MAC address	-	-	
S-0-1020	IP address	192.168.0.100	-	
S-0-1020.0.1	Current IP address	-	-	
S-0-1021	Subnet mask	255.255.255.0	-	

S-0-1021.0.1	Current Subnet mask	-	-	
S-0-1022	Gateway node number	192.168.0.1	-	
S-0-1022.0.1	Current Gateway node number	-	-	
S-0-1023	SYNC jitter	-	us	
S-0-1024	SYNC delay measuring procedure command (Process Command)	-	-	
S-0-1026	Version of communication hardware	-	-	
S-0-1027.0.1	Requested MTU	-	-	
S-0-1027.0.2	Effective MTU	-	-	
S-0-1028	Error counter MST-P/S	-	-	
S-0-1031	Test pin assignment Port 1 and Port 2	-	-	
S-0-1035	Error counter Port1 and Port2	-	-	
S-0-1035.0.1	Error counter P&S	-	-	
S-0-1036	Interframe Gap	-	-	
S-0-1037	Slave Jitter	-	-	
S-0-1040	Sercos address	1	-	
S-0-1041	AT Command value valid time (t9)	-	us	
S-0-1044	Device control	-	-	
S-0-1045	Device status	-	-	
S-0-1047	Maximum consumer activation time (t11)	-	us	
S-0-1048	Procedure Command – Activate IP Settings	-	-	
S-0-1050.x.1	Connection setup	-	-	
S-0-1050.x.2	Connection number	-	-	
S-0-1050.x.3	Telegram assignment	-	-	
S-0-1050.x.4	Max. length of connection	-	-	
S-0-1050.x.5	Current length of connection	-	-	
S-0-1050.x.6	Configuration list	-	-	
S-0-1050.x.8	Connection control	-	-	
S-0-1050.x.10	Producer cycle time	-	us	
S-0-1050.x.11	Allowed data losses	-	-	
S-0-1050.x.12	Error counter data losses	-	-	
S-0-1050.x.20	IDN allocation of real-time bit	-	-	
S-0-1050.x.21	Bit allocation of real-time bit	-	-	
S-0-1051	Image of connection setups	-	-	
S-0-1300.0.1	Component name	-	-	
S-0-1300.0.2	Vendor name	-	-	
S-0-1300.0.3	Vendor code	-	-	
S-0-1300.0.4	Device name	-	-	
S-0-1300.0.5	Device ID	-	-	
S-0-1300.0.7	Function revision	-	-	
S-0-1300.0.8	Hardware revision	-	-	
S-0-1300.0.9	Firmware revision	-	-	
S-0-1300.0.10	Firmware loader revision	-	-	
S-0-1300.0.11	Order number	-	-	

S-0-1300.0.12	Serial number	-	-	
S-0-1300.0.13	Manufacturing date parameter	-	-	
S-0-1300.0.14	QA Date	-	-	
S-0-1300.0.20	Operational hours.	-	h	
S-0-1300.0.21	Service Date	-	-	
S-0-1301	List of GDP classes & version	-	-	
S-0-1302.0.1	FSP type & version	-	-	
S-0-1302.0.2	Function groups	-	-	
S-0-1302.0.3	Application type	-	-	
S-0-1303.0.1 ¹⁰	Diagnosis trace configuration	-	-	
S-0-1303.0.2	Diagnosis trace control	-	-	
S-0-1303.0.3	Diagnosis trace state	-	-	
S-0-1303.0.10	Diagnosis trace buffer no1	-	-	
S-0-1303.0.11	Diagnosis trace buffer no2	-	-	
S-0-1305.0.1	Sercos current time	-	-	
S-0-1305.0.2	Sercos current fine time	-		
S-0-1305.0.3	Sercos current coarse time	-		
S-0-1350	Reboot device	-	-	
S-0-1500	IO bus coupler	-	-	
S-0-1500.0.1	IO control	-	-	
S-0-1500.0.2	IO status	-	-	
S-0-1500.0.3	List of module type codes	-	-	
S-0-1500.0.5	Container output data	-	-	
S-0-1500.0.9	Container input data	-	-	
S-0-1500.0.19	Parameter channel receive	-	-	
S-0-1500.0.20	Parameter channel transmit	-	-	
S-0-1500.0.32	IO diagnostic message	-	-	
S-0-1500.0.33	Current IO diagnostic message	-	-	
S-0-1502	IO function group digital output	-	-	
S-0-1502.0.1	Name of IO FG	-	-	
S-0-1502.0.2	Configuration of IO FG	-	-	
S-0-1502.0.3	Channel quantity PDOOUT	-	-	
S-0-1502.0.4	Channel width PDOOUT	-	-	
S-0-1502.0.5	PDOOUT	-	-	
S-0-1502.0.15	Channel Quantity DIAGIN	-	-	
S-0-1502.0.16	Channel width DIAGIN	-	-	
S-0-1502.0.17	DIAGIN	-	-	
S-0-1502.0.22	Fallback Value Output	-	-	
S-0-1502.0.23	Min. Delay time	-	-	
S-0-1502.0.24	Max. Delay time	-	-	
S-0-1503	IO function group digital input	-	-	
S-0-1503.0.1	Name of IO FG	-	-	
S-0-1503.0.2	Configuration of IO FG	-	-	

S-0-1503.0.7	Channel quantity PDIN	-	-	
S-0-1503.0.8	Channel width PDIN	-	-	
S-0-1503.0.9	PDIN	-	-	
S-0-1503.0.15	Channel Quantity DIAGIN	-	-	
S-0-1503.0.16	Channel width DIAGIN	-	-	
S-0-1503.0.17	DIAGIN	-	-	
S-0-1503.0.23	Min. Delay time	-	-	
S-0-1503.0.24	Max. Delay time	-	-	

17.2 IDN for gateway configuration

The following configuration will be transmitted through the IDN S-0-1502.0.20 (Parameter channel transmit)

Byte No.	Description	Value
Gateway configuration		
0	Gateway node number (0-16)	
	DIP switch setting	0
	Gateway node number 0	1
	Gateway node number 1	2

	Gateway node number 15	15
Data to Pluto configuration		
1	Data to Pluto Update Time (ms).	
	Value modulus	4 - 250
2 – 3	Data to Pluto Timeout (ms)	
	timeout disabled	0
	Valid value in ms.	1 - 65535
4	Enable Data to Pluto (bit or:ed data)	
	Data to Pluto 1	0x1
	Data to Pluto 2	0x2
	Data to Pluto 3	0x4
	Data to Pluto 4	0x8
Additional Data configuration		
5	Additional Data 00, Pluto node (0-31)	0 – 31
6	Additional Data 00, IO-type	0 – 255
7	Additional Data 01, Pluto node (0-31)	0 – 31
8	Additional Data 01, IO-type	0 – 255
9	Additional Data 02, Pluto node (0-31)	0 – 31
10	Additional Data 02, IO-type	0 – 255
11	Additional Data 03, Pluto node (0-31)	0 – 31
12	Additional Data 03, IO-type	0 – 255
13	Additional Data 04, Pluto node (0-31)	0 – 31
14	Additional Data 04, IO-type	0 – 255
15	Additional Data 05, Pluto node (0-31)	0 – 31
16	Additional Data 05, IO-type	0 – 255
17	Additional Data 06, Pluto node (0-31)	0 – 31

Byte No.	Description	Value
18	Additional Data 06, IO-type	0 – 255
19	Additional Data 07, Pluto node (0-31)	0 – 31
20	Additional Data 07, IO-type	0 – 255
21	Additional Data 08, Pluto node (0-31)	0 – 31
22	Additional Data 08, IO-type	0 – 255
23	Additional Data 09, Pluto node (0-31)	0 – 31
24	Additional Data 09, IO-type	0 – 255
25	Additional Data 10, Pluto node (0-31)	0 – 31
26	Additional Data 10, IO-type	0 – 255
27	Additional Data 11, Pluto node (0-31)	0 – 31
28	Additional Data 11, IO-type	0 – 255
29	Additional Data 12, Pluto node (0-31)	0 – 31
30	Additional Data 12, IO-type	0 – 255
31	Additional Data 13, Pluto node (0-31)	0 – 31
32	Additional Data 13, IO-type	0 – 255
33	Additional Data 14, Pluto node (0-31)	0 – 31
34	Additional Data 14, IO-type	0 – 255
35	Additional Data 15, Pluto node (0-31)	0 – 31
36	Additional Data 15, IO-type	0 – 255
37	Additional Data 16, Pluto node (0-31)	0 – 31
38	Additional Data 16, IO-type	0 – 255
39	Additional Data 17, Pluto node (0-31)	0 – 31
40	Additional Data 17, IO-type	0 – 255
41	Additional Data 18, Pluto node (0-31)	0 – 31
42	Additional Data 18, IO-type	0 – 255
43	Additional Data 19, Pluto node (0-31)	0 – 31
44	Additional Data 19, IO-type	0 – 255
45	Additional Data 20, Pluto node (0-31)	0 – 31
46	Additional Data 20, IO-type	0 – 255
47	Additional Data 21, Pluto node (0-31)	0 – 31
48	Additional Data 21, IO-type	0 – 255
49	Additional Data 22, Pluto node (0-31)	0 – 31
50	Additional Data 22, IO-type	0 – 255
51	Additional Data 23, Pluto node (0-31)	0 – 31
52	Additional Data 23, IO-type	0 – 255
53	Additional Data 24, Pluto node (0-31)	0 – 31
54	Additional Data 24, IO-type	0 – 255
55	Additional Data 25, Pluto node (0-31)	0 – 31
56	Additional Data 25, IO-type	0 – 255
57	Additional Data 26, Pluto node (0-31)	0 – 31
58	Additional Data 26, IO-type	0 – 255
59	Additional Data 27, Pluto node (0-31)	0 – 31
60	Additional Data 27, IO-type	0 – 255
61	Additional Data 28, Pluto node (0-31)	0 – 31
62	Additional Data 28, IO-type	0 – 255
63	Additional Data 29, Pluto node (0-31)	0 – 31
64	Additional Data 29, IO-type	0 – 255
65	Additional Data 30, Pluto node (0-31)	Not used
66	Additional Data 30, IO-type	Not used
67	Additional Data 31, Pluto node (0-31)	Not used
68	Additional Data 31, IO-type	Not used

Element		Value	Note
name		Configuration of Pluto	
attribute	length (octet)	67	
	data type & display format	unsigned integer & binary	
	function	parameter	
	positions after decimal point		
	write protection	never	
	conversion factor		
	unit		
minimum value		n/a	
maximum value		n/a	
scaling		1	
scope of parameter		local	

18 Appendix E, object description PROFINET

Pluto Gateway	
Vendor	ABB AB
Vendor ID	0x0184
Product family	Pluto Gateway
Device-ID	0x03E8
Details	Pluto Gateway PROFINET
Content	
Device Access Points	
Modules	
Parameter of Modules	

Device Access Points

Device Access Point: GATE-E2 (Compatibility Mode)								
Module Ident Number	0x00000100							
Details	Pluto Gateway PROFINET (Compatibility Mode)							
Vendor Name	ABB AB							
Order Number	2TLA020071R8300							
Software Version	1.0							
Hardware Version	1.0							
Maximal Input Length	1440 Bytes							
Maximal Output Length	1440 Bytes							
Physical Slots	0..15							
Minimal Device Interval	8 ms							
Based on	RTA ConnectMe							
DNS Compliant Name	GATEE2							
Supports Extended Assignment of IP Address	No							
Fixed in Slots	0							
Instance Field of the Object UUID	1							
Supports Multiple Write	No							
Requires IOPS/IOCS	Yes							
IP Address Assignment Methods	DCP							
Remote Application Timeout	300 s							
Submodule: GATE-E2 (Compatibility Mode)								
Submodule Ident Number	0x00000000							
Details	Pluto Gateway PROFINET (Compatibility Mode)							
Length of the IO Producer Status	1							
Length of the IO Consumer Status	1							
Gateway Data to Pluto timeout (Index: 1 -- Length: 2 Byte -- Transfersequence: 0)								
Name of Parameter	Data Type	Byte Offset	Bit Offset	Bit Length	Defaultvalue	Value Range	Changeable	Visible
Timeout [ms]	Unsigned16	0			0	0..60000	Yes	Yes
Pluto Data to Pluto cycletime (Index: 2 -- Length: 1 Byte -- Transfersequence: 0)								
Name of Parameter	Data Type	Byte Offset	Bit Offset	Bit Length	Defaultvalue	Value Range	Changeable	Visible
Cycletime [ms]	Unsigned8	0			100	0..250	Yes	Yes
Gateway Node Address (Index: 42 -- Length: 1 Byte -- Transfersequence: 0)								
Name of Parameter	Data Type	Byte Offset	Bit Offset	Bit Length	Defaultvalue	Value Range	Changeable	Visible

Gateway Node Address	Unsigned8	0		DIP-Switch Setting	0..16	Yes	Yes
Useable Modules							
Name	Information				Allowed in Slots	Used in Slots	Fixed in Slots
Node Status	Show which Pluto units are active on Pluto bus.				1..1		
Pluto Nodes 00-07	Global variables from Pluto 0-7.				2..2		
Pluto Nodes 08-15	Global variables from Pluto 8-15.				3..3		
Pluto Nodes 16-23	Global variables from Pluto 16-23.				4..4		
Pluto Nodes 24-31	Global variables from Pluto 24-31.				5..5		
Additional Data Area 00-07	Additional data from Pluto.				6..6		
Additional Data Area 08-15	Additional data from Pluto.				7..7		
Additional Data Area 16-23	Additional data from Pluto.				8..8		
Additional Data Area 24-31	Additional data from Pluto.				9..9		
Data to Pluto Area 0	Data to Pluto.				10..10		
Data to Pluto Area 1	Data to Pluto.				11..11		
Data to Pluto Area 2	Data to Pluto.				12..12		
Data to Pluto Area 3	Data to Pluto.				13..13		
Local Data Request	Request to Pluto for variable data.				14..14		
Local Data Response	Response from Pluto for variable data.				15..15		

Device Access Point: GATE-PN	
Module Ident Number	0x00200000
Details	Pluto Gateway PROFINET
Vendor Name	ABB AB
Order Number	2TLA020071R9300
Software Version	1.0
Hardware Version	1.0
Maximal Input Length	1440 Bytes
Maximal Output Length	1440 Bytes
Physical Slots	0..15
Minimal Device Interval	1 ms
Based on	netX
DNS Compliant Name	gatepn
Supports Extended Assignment of IP Address	No
Fixed in Slots	0
Instance Field of the Object UUID	1
Supports Multiple Write	Yes
Requires IOPS/IOCS	Yes
IP Address Assignment Methods	DCP
Remote Application Timeout	300 s
Subslots of Module	
Subslot Number	Subslot Label
32768 (0x8000)	X1
32769 (0x8001)	X1 P1
32770 (0x8002)	X1 P2
Submodule: GATE-E2 (Compatibility Mode)	
Submodule Ident	0x00200000

Number								
Details	Pluto Gateway PROFINET (Compatibility Mode)							
Writeable IM Records	No							
Length of the IO Producer Status	1							
Length of the IO Consumer Status	1							
Gateway Data to Pluto timeout (Index: 1 -- Length: 2 Byte -- Transfersequence: 0)								
Name of Parameter	Data Type	Byte Offset	Bit Offset	Bit Length	Defaultvalue	Value Range	Changeable	Visible
Timeout [ms]	Unsigned16	0			0	0..60000	Yes	Yes
Pluto Data to Pluto cycletime (Index: 2 -- Length: 1 Byte -- Transfersequence: 0)								
Name of Parameter	Data Type	Byte Offset	Bit Offset	Bit Length	Defaultvalue	Value Range	Changeable	Visible
Cycletime [ms]	Unsigned8	0			100	0..250	Yes	Yes
Gateway Node Address (Index: 42 -- Length: 1 Byte -- Transfersequence: 0)								
Name of Parameter	Data Type	Byte Offset	Bit Offset	Bit Length	Defaultvalue	Value Range	Changeable	Visible
Gateway Node Address	Unsigned8	0			DIP-Switch Setting	0..16	Yes	Yes
Interface: PN-IO								
Submodule Ident Number	0x00200001							
Subslot Number	32768 (0x8000)							
Supports Realtime Class	Class1							
Supports Realtime Classes	RT_CLASS_1;RT_CLASS_3							
Supports Isochronous Mode	No							
Supported Protocols	SNMP;LLDP							
Supported MIBs	MIB2							
Supports Network Component Diagnosis	Yes							
Maximal Bridge Delay	5500 ns							
Maximal Number of IR-Frame Data	256							
Synchronisation Mode	SyncSlave							
Maximal Local Jitter	50 ns							
T_PLL_MAX	1000 ns							
Supported Sendclock Factors (Base 31,25µs)	32 64 128							
Supported Sendclock Factors for RT Class 3 (Base 31,25µs)	8 16 32 64 128							
Supported Reduction Ratios	1 2 4 8 16 32 64 128 256 512							
Supported Reduction Ratios for RT Class 3	1 2 4 8 16							
Supports RT Media Redundancy	Yes							
Supported Role	Client							
Port 1: Port 1								
Submodule Ident Number	0x00200002							
Subslot Number	32769 (0x8001)							
MAU Types	16							
MaxPortTxDelay	92 ns							
MaxPortRxDelay	340 ns							
Port Deactivation Supported	Yes							

Link State Diagnosis Capability	No			
Is Default Ringport	Yes			
Port 2: Port 2				
Submodule Ident Number	0x00200002			
Subslot Number	32770 (0x8002)			
MAU Types	16			
MaxPortTxDelay	92 ns			
MaxPortRxDelay	340 ns			
Port Deactivation Supported	Yes			
Link State Diagnosis Capability	No			
Is Default Ringport	Yes			
Useable Modules				
Name	Information	Allowed in Slots	Used in Slots	Fixed in Slots
Node Status	Show which Pluto units are active on Pluto bus.	1..1		
Pluto Nodes 00-07	Global variables from Pluto 0-7.	2..2		
Pluto Nodes 08-15	Global variables from Pluto 8-15.	3..3		
Pluto Nodes 16-23	Global variables from Pluto 16-23.	4..4		
Pluto Nodes 24-31	Global variables from Pluto 24-31.	5..5		
Additional Data Area 00-07	Additional data from Pluto.	6..6		
Additional Data Area 08-15	Additional data from Pluto.	7..7		
Additional Data Area 16-23	Additional data from Pluto.	8..8		
Additional Data Area 24-31	Additional data from Pluto.	9..9		
Data to Pluto Area 0	Data to Pluto.	10..10		
Data to Pluto Area 1	Data to Pluto.	11..11		
Data to Pluto Area 2	Data to Pluto.	12..12		
Data to Pluto Area 3	Data to Pluto.	13..13		

Modules

Module: Node Status								
Module Ident Number	0x02000101							
Details	Show which Pluto units are active on Pluto bus.							
Order Number	N/A							
Category	01-Status							
Software Version	1.0							
Hardware Version	1.0							
Submodule: Node Status								
Submodule Ident Number	0x02000101							
Details	Show which Pluto units are active on Pluto bus.							
Cyclic Input Data							Item consistency	
Name	Data Type	Display as Bits	Length [Bytes]					
Node Status	Unsigned32	Yes						
Status (Index: 3 -- Length: 1 Byte -- Transfersequence: 0)								
Name of Parameter	Data Type	Byte Offset	Bit Offset	Bit Length	Defaultvalue	Value Range	Changeable	Visible
Module usage	Bit	0	0		Enable	0..1	Yes	Yes

Module: Pluto Nodes 00-07

Module Ident Number	0x02000201							
Details	Global variables from Pluto 0-7.							
Order Number	N/A							
Category	02-Pluto Nodes							
Software Version	1.0							
Hardware Version	1.0							
Submodule: Pluto Nodes 00-07								
Submodule Ident Number	0x02000201							
Details	Global variables from Pluto 0-7.							
Cyclic Input Data							Item consistency	
Name	Data Type	Display as Bits	Length [Bytes]					
Node 00 Data	Unsigned32	Yes						
Node 01 Data	Unsigned32	Yes						
Node 02 Data	Unsigned32	Yes						
Node 03 Data	Unsigned32	Yes						
Node 04 Data	Unsigned32	Yes						
Node 05 Data	Unsigned32	Yes						
Node 06 Data	Unsigned32	Yes						
Node 07 Data	Unsigned32	Yes						
Pluto Nodes 0-7 (Index: 4 -- Length: 1 Byte -- Transfersequence: 0)								
Name of Parameter	Data Type	Byte Offset	Bit Offset	Bit Length	Defaultvalue	Value Range	Changeable	Visible
Module usage	Bit	0	0		Enable	0..1	Yes	Yes

Module: Pluto Nodes 08-15								
Module Ident Number	0x02000202							
Details	Global variables from Pluto 8-15.							
Order Number	N/A							
Category	02-Pluto Nodes							
Software Version	1.0							
Hardware Version	1.0							
Submodule: Pluto Nodes 08-15								
Submodule Ident Number	0x02000202							
Details	Global variables from Pluto 8-15.							
Cyclic Input Data							Item consistency	
Name	Data Type	Display as Bits	Length [Bytes]					
Node 08 Data	Unsigned32	Yes						
Node 09 Data	Unsigned32	Yes						
Node 10 Data	Unsigned32	Yes						
Node 11 Data	Unsigned32	Yes						
Node 12 Data	Unsigned32	Yes						
Node 13 Data	Unsigned32	Yes						
Node 14 Data	Unsigned32	Yes						
Node 15 Data	Unsigned32	Yes						
Pluto Nodes 8-15 (Index: 5 -- Length: 1 Byte -- Transfersequence: 0)								
Name of Parameter	Data Type	Byte Offset	Bit Offset	Bit Length	Defaultvalue	Value Range	Changeable	Visible
Module usage	Bit	0	0		Enable	0..1	Yes	Yes

Module: Pluto Nodes 16-23								
Module Ident Number	0x02000203							
Details	Global variables from Pluto 16-23.							
Order Number	N/A							

Category	02-Pluto Nodes							
Software Version	1.0							
Hardware Version	1.0							
Submodule: Pluto Nodes 16-23								
Submodule Ident Number	0x02000203							
Details	Global variables from Pluto 16-23.							
Cyclic Input Data			Item consistency					
Name	Data Type	Display as Bits	Length [Bytes]					
Node 16 Data	Unsigned32	Yes						
Node 17 Data	Unsigned32	Yes						
Node 18 Data	Unsigned32	Yes						
Node 19 Data	Unsigned32	Yes						
Node 20 Data	Unsigned32	Yes						
Node 21 Data	Unsigned32	Yes						
Node 22 Data	Unsigned32	Yes						
Node 23 Data	Unsigned32	Yes						
Pluto Nodes 16-23 (Index: 6 -- Length: 1 Byte -- Transfersequence: 0)								
Name of Parameter	Data Type	Byte Offset	Bit Offset	Bit Length	Defaultvalue	Value Range	Changeable	Visible
Module usage	Bit	0	0		Enable	0..1	Yes	Yes

Module: Pluto Nodes 24-31								
Module Ident Number	0x02000204							
Details	Global variables from Pluto 24-31.							
Order Number	N/A							
Category	02-Pluto Nodes							
Software Version	1.0							
Hardware Version	1.0							
Submodule: Pluto Nodes 24-31								
Submodule Ident Number	0x02000204							
Details	Global variables from Pluto 24-31.							
Cyclic Input Data			Item consistency					
Name	Data Type	Display as Bits	Length [Bytes]					
Node 24 Data	Unsigned32	Yes						
Node 25 Data	Unsigned32	Yes						
Node 26 Data	Unsigned32	Yes						
Node 27 Data	Unsigned32	Yes						
Node 28 Data	Unsigned32	Yes						
Node 29 Data	Unsigned32	Yes						
Node 30 Data	Unsigned32	Yes						
Node 31 Data	Unsigned32	Yes						
Pluto Nodes 24-31 (Index: 7 -- Length: 1 Byte -- Transfersequence: 0)								
Name of Parameter	Data Type	Byte Offset	Bit Offset	Bit Length	Defaultvalue	Value Range	Changeable	Visible
Module usage	Bit	0	0		Enable	0..1	Yes	Yes

Module: Additional Data Area 00-07	
Module Ident Number	0x02000301
Details	Additional data from Pluto.
Order Number	N/A
Category	05-Additional Data
Software Version	1.0
Hardware Version	1.0

Submodule: Additional Data Area 00-07								
Submodule Ident Number	0x02000301							
Details	Additional data from Pluto.							
Cyclic Input Data								Item consistency
Name	Data Type	Display as Bits	Length [Bytes]					
Additional Data Area 00	Unsigned32	Yes						
Additional Data Area 01	Unsigned32	Yes						
Additional Data Area 02	Unsigned32	Yes						
Additional Data Area 03	Unsigned32	Yes						
Additional Data Area 04	Unsigned32	Yes						
Additional Data Area 05	Unsigned32	Yes						
Additional Data Area 06	Unsigned32	Yes						
Additional Data Area 07	Unsigned32	Yes						
Additional Data Area 00 (Index: 8 -- Length: 2 Byte -- Transfersequence: 0)								
Name of Parameter	Data Type	Byte Offset	Bit Offset	Bit Length	Defaultvalue	Value Range	Changeable	Visible
From Pluto Node	Unsigned8	0			Pluto 00	0..31	Yes	Yes
IO type	Unsigned8	1			UNUSED	0..114	Yes	Yes
Additional Data Area 01 (Index: 9 -- Length: 2 Byte -- Transfersequence: 0)								
Name of Parameter	Data Type	Byte Offset	Bit Offset	Bit Length	Defaultvalue	Value Range	Changeable	Visible
From Pluto Node	Unsigned8	0			Pluto 00	0..31	Yes	Yes
IO type	Unsigned8	1			UNUSED	0..114	Yes	Yes
Additional Data Area 02 (Index: 10 -- Length: 2 Byte -- Transfersequence: 0)								
Name of Parameter	Data Type	Byte Offset	Bit Offset	Bit Length	Defaultvalue	Value Range	Changeable	Visible
From Pluto Node	Unsigned8	0			Pluto 00	0..31	Yes	Yes
IO type	Unsigned8	1			UNUSED	0..114	Yes	Yes
Additional Data Area 03 (Index: 11 -- Length: 2 Byte -- Transfersequence: 0)								
Name of Parameter	Data Type	Byte Offset	Bit Offset	Bit Length	Defaultvalue	Value Range	Changeable	Visible
From Pluto Node	Unsigned8	0			Pluto 00	0..31	Yes	Yes
IO type	Unsigned8	1			UNUSED	0..114	Yes	Yes
Additional Data Area 04 (Index: 12 -- Length: 2 Byte -- Transfersequence: 0)								
Name of Parameter	Data Type	Byte Offset	Bit Offset	Bit Length	Defaultvalue	Value Range	Changeable	Visible
From Pluto Node	Unsigned8	0			Pluto 00	0..31	Yes	Yes
IO type	Unsigned8	1			UNUSED	0..114	Yes	Yes
Additional Data Area 05 (Index: 13 -- Length: 2 Byte -- Transfersequence: 0)								
Name of Parameter	Data Type	Byte Offset	Bit Offset	Bit Length	Defaultvalue	Value Range	Changeable	Visible
From Pluto Node	Unsigned8	0			Pluto 00	0..31	Yes	Yes
IO type	Unsigned8	1			UNUSED	0..114	Yes	Yes
Additional Data Area 06 (Index: 14 -- Length: 2 Byte -- Transfersequence: 0)								
Name of Parameter	Data Type	Byte Offset	Bit Offset	Bit Length	Defaultvalue	Value Range	Changeable	Visible
From Pluto Node	Unsigned8	0			Pluto 00	0..31	Yes	Yes
IO type	Unsigned8	1			UNUSED	0..114	Yes	Yes
Additional Data Area 07 (Index: 15 -- Length: 2 Byte -- Transfersequence: 0)								
Name of Parameter	Data Type	Byte Offset	Bit Offset	Bit Length	Defaultvalue	Value Range	Changeable	Visible
From Pluto Node	Unsigned8	0			Pluto 00	0..31	Yes	Yes

IO type	Unsigned8	1			UNUSED	0..114	Yes	Yes
---------	-----------	---	--	--	--------	--------	-----	-----

Module: Additional Data Area 08-15								
Module Ident Number	0x02000302							
Details	Additional data from Pluto.							
Order Number	N/A							
Category	05-Additional Data							
Software Version	1.0							
Hardware Version	1.0							
Submodule: Additional Data Area 08-15								
Submodule Ident Number	0x02000302							
Details	Additional data from Pluto.							
Cyclic Input Data							Item consistency	
Name	Data Type	Display as Bits	Length [Bytes]					
Additional Data Area 08	Unsigned32	Yes						
Additional Data Area 09	Unsigned32	Yes						
Additional Data Area 10	Unsigned32	Yes						
Additional Data Area 11	Unsigned32	Yes						
Additional Data Area 12	Unsigned32	Yes						
Additional Data Area 13	Unsigned32	Yes						
Additional Data Area 14	Unsigned32	Yes						
Additional Data Area 15	Unsigned32	Yes						
Additional Data Area 08 (Index: 16 -- Length: 2 Byte -- Transfersequence: 0)								
Name of Parameter	Data Type	Byte Offset	Bit Offset	Bit Length	Defaultvalue	Value Range	Changeable	Visible
From Pluto Node	Unsigned8	0			Pluto 00	0..31	Yes	Yes
IO type	Unsigned8	1			UNUSED	0..114	Yes	Yes
Additional Data Area 09 (Index: 17 -- Length: 2 Byte -- Transfersequence: 0)								
Name of Parameter	Data Type	Byte Offset	Bit Offset	Bit Length	Defaultvalue	Value Range	Changeable	Visible
From Pluto Node	Unsigned8	0			Pluto 00	0..31	Yes	Yes
IO type	Unsigned8	1			UNUSED	0..114	Yes	Yes
Additional Data Area 10 (Index: 18 -- Length: 2 Byte -- Transfersequence: 0)								
Name of Parameter	Data Type	Byte Offset	Bit Offset	Bit Length	Defaultvalue	Value Range	Changeable	Visible
From Pluto Node	Unsigned8	0			Pluto 00	0..31	Yes	Yes
IO type	Unsigned8	1			UNUSED	0..114	Yes	Yes
Additional Data Area 11 (Index: 19 -- Length: 2 Byte -- Transfersequence: 0)								
Name of Parameter	Data Type	Byte Offset	Bit Offset	Bit Length	Defaultvalue	Value Range	Changeable	Visible
From Pluto Node	Unsigned8	0			Pluto 00	0..31	Yes	Yes
IO type	Unsigned8	1			UNUSED	0..114	Yes	Yes
Additional Data Area 12 (Index: 20 -- Length: 2 Byte -- Transfersequence: 0)								
Name of Parameter	Data Type	Byte Offset	Bit Offset	Bit Length	Defaultvalue	Value Range	Changeable	Visible
From Pluto Node	Unsigned8	0			Pluto 00	0..31	Yes	Yes
IO type	Unsigned8	1			UNUSED	0..114	Yes	Yes
Additional Data Area 13 (Index: 21 -- Length: 2 Byte -- Transfersequence: 0)								
Name of Parameter	Data Type	Byte Offset	Bit Offset	Bit Length	Defaultvalue	Value Range	Changeable	Visible

From Pluto Node	Unsigned8	0			Pluto 00	0..31	Yes	Yes
IO type	Unsigned8	1			UNUSED	0..114	Yes	Yes
Additional Data Area 14 (Index: 22 -- Length: 2 Byte -- Transfersequence: 0)								
Name of Parameter	Data Type	Byte Offset	Bit Offset	Bit Length	Defaultvalue	Value Range	Changeable	Visible
From Pluto Node	Unsigned8	0			Pluto 00	0..31	Yes	Yes
IO type	Unsigned8	1			UNUSED	0..114	Yes	Yes
Additional Data Area 15 (Index: 23 -- Length: 2 Byte -- Transfersequence: 0)								
Name of Parameter	Data Type	Byte Offset	Bit Offset	Bit Length	Defaultvalue	Value Range	Changeable	Visible
From Pluto Node	Unsigned8	0			Pluto 00	0..31	Yes	Yes
IO type	Unsigned8	1			UNUSED	0..114	Yes	Yes

Module: Additional Data Area 16-23								
Module Ident Number	0x02000303							
Details	Additional data from Pluto.							
Order Number	N/A							
Category	05-Additional Data							
Software Version	1.0							
Hardware Version	1.0							
Submodule: Additional Data Area 16-23								
Submodule Ident Number	0x02000303							
Details	Additional data from Pluto.							
Cyclic Input Data							Item consistency	
Name	Data Type	Display as Bits	Length [Bytes]					
Additional Data Area 16	Unsigned32	Yes						
Additional Data Area 17	Unsigned32	Yes						
Additional Data Area 18	Unsigned32	Yes						
Additional Data Area 19	Unsigned32	Yes						
Additional Data Area 20	Unsigned32	Yes						
Additional Data Area 21	Unsigned32	Yes						
Additional Data Area 22	Unsigned32	Yes						
Additional Data Area 23	Unsigned32	Yes						
Additional Data Area 16 (Index: 24 -- Length: 2 Byte -- Transfersequence: 0)								
Name of Parameter	Data Type	Byte Offset	Bit Offset	Bit Length	Defaultvalue	Value Range	Changeable	Visible
From Pluto Node	Unsigned8	0			Pluto 00	0..31	Yes	Yes
IO type	Unsigned8	1			UNUSED	0..114	Yes	Yes
Additional Data Area 17 (Index: 25 -- Length: 2 Byte -- Transfersequence: 0)								
Name of Parameter	Data Type	Byte Offset	Bit Offset	Bit Length	Defaultvalue	Value Range	Changeable	Visible
From Pluto Node	Unsigned8	0			Pluto 00	0..31	Yes	Yes
IO type	Unsigned8	1			UNUSED	0..114	Yes	Yes
Additional Data Area 18 (Index: 26 -- Length: 2 Byte -- Transfersequence: 0)								
Name of Parameter	Data Type	Byte Offset	Bit Offset	Bit Length	Defaultvalue	Value Range	Changeable	Visible
From Pluto Node	Unsigned8	0			Pluto 00	0..31	Yes	Yes
IO type	Unsigned8	1			UNUSED	0..114	Yes	Yes
Additional Data Area 19 (Index: 27 -- Length: 2 Byte -- Transfersequence: 0)								
Name of Parameter	Data Type	Byte	Bit Offset	Bit	Defaultvalue	Value	Changeable	Visible

		Offset		Length		Range		
From Pluto Node	Unsigned8	0			Pluto 00	0..31	Yes	Yes
IO type	Unsigned8	1			UNUSED	0..114	Yes	Yes
Additional Data Area 20 (Index: 28 -- Length: 2 Byte -- Transfersequence: 0)								
Name of Parameter	Data Type	Byte Offset	Bit Offset	Bit Length	Defaultvalue	Value Range	Changeable	Visible
From Pluto Node	Unsigned8	0			Pluto 00	0..31	Yes	Yes
IO type	Unsigned8	1			UNUSED	0..114	Yes	Yes
Additional Data Area 21 (Index: 29 -- Length: 2 Byte -- Transfersequence: 0)								
Name of Parameter	Data Type	Byte Offset	Bit Offset	Bit Length	Defaultvalue	Value Range	Changeable	Visible
From Pluto Node	Unsigned8	0			Pluto 00	0..31	Yes	Yes
IO type	Unsigned8	1			UNUSED	0..114	Yes	Yes
Additional Data Area 22 (Index: 30 -- Length: 2 Byte -- Transfersequence: 0)								
Name of Parameter	Data Type	Byte Offset	Bit Offset	Bit Length	Defaultvalue	Value Range	Changeable	Visible
From Pluto Node	Unsigned8	0			Pluto 00	0..31	Yes	Yes
IO type	Unsigned8	1			UNUSED	0..114	Yes	Yes
Additional Data Area 23 (Index: 31 -- Length: 2 Byte -- Transfersequence: 0)								
Name of Parameter	Data Type	Byte Offset	Bit Offset	Bit Length	Defaultvalue	Value Range	Changeable	Visible
From Pluto Node	Unsigned8	0			Pluto 00	0..31	Yes	Yes
IO type	Unsigned8	1			UNUSED	0..114	Yes	Yes

Module: Additional Data Area 24-31								
Module Ident Number	0x02000304							
Details	Additional data from Pluto.							
Order Number	N/A							
Category	05-Additional Data							
Software Version	1.0							
Hardware Version	1.0							
Submodule: Additional Data Area 24-31								
Submodule Ident Number	0x02000304							
Details	Additional data from Pluto.							
Cyclic Input Data							Item consistency	
Name	Data Type	Display as Bits	Length [Bytes]					
Additional Data Area 24	Unsigned32	Yes						
Additional Data Area 25	Unsigned32	Yes						
Additional Data Area 26	Unsigned32	Yes						
Additional Data Area 27	Unsigned32	Yes						
Additional Data Area 28	Unsigned32	Yes						
Additional Data Area 29	Unsigned32	Yes						
Additional Data Area 30	Unsigned32	Yes						
Additional Data Area 31	Unsigned32	Yes						
Additional Data Area 24 (Index: 32 -- Length: 2 Byte -- Transfersequence: 0)								
Name of Parameter	Data Type	Byte Offset	Bit Offset	Bit Length	Defaultvalue	Value Range	Changeable	Visible
From Pluto Node	Unsigned8	0			Pluto 00	0..31	Yes	Yes
IO type	Unsigned8	1			UNUSED	0..114	Yes	Yes
Additional Data Area 25 (Index: 33 -- Length: 2 Byte -- Transfersequence: 0)								

Name of Parameter	Data Type	Byte Offset	Bit Offset	Bit Length	Defaultvalue	Value Range	Changeable	Visible
From Pluto Node	Unsigned8	0			Pluto 00	0..31	Yes	Yes
IO type	Unsigned8	1			UNUSED	0..114	Yes	Yes
Additional Data Area 26 (Index: 34 -- Length: 2 Byte -- Transfersequence: 0)								
Name of Parameter	Data Type	Byte Offset	Bit Offset	Bit Length	Defaultvalue	Value Range	Changeable	Visible
From Pluto Node	Unsigned8	0			Pluto 00	0..31	Yes	Yes
IO type	Unsigned8	1			UNUSED	0..114	Yes	Yes
Additional Data Area 27 (Index: 35 -- Length: 2 Byte -- Transfersequence: 0)								
Name of Parameter	Data Type	Byte Offset	Bit Offset	Bit Length	Defaultvalue	Value Range	Changeable	Visible
From Pluto Node	Unsigned8	0			Pluto 00	0..31	Yes	Yes
IO type	Unsigned8	1			UNUSED	0..114	Yes	Yes
Additional Data Area 28 (Index: 36 -- Length: 2 Byte -- Transfersequence: 0)								
Name of Parameter	Data Type	Byte Offset	Bit Offset	Bit Length	Defaultvalue	Value Range	Changeable	Visible
From Pluto Node	Unsigned8	0			Pluto 00	0..31	Yes	Yes
IO type	Unsigned8	1			UNUSED	0..114	Yes	Yes
Additional Data Area 29 (Index: 37 -- Length: 2 Byte -- Transfersequence: 0)								
Name of Parameter	Data Type	Byte Offset	Bit Offset	Bit Length	Defaultvalue	Value Range	Changeable	Visible
From Pluto Node	Unsigned8	0			Pluto 00	0..31	Yes	Yes
IO type	Unsigned8	1			UNUSED	0..114	Yes	Yes
Additional Data Area 30 (Index: 38 -- Length: 2 Byte -- Transfersequence: 0)								
Name of Parameter	Data Type	Byte Offset	Bit Offset	Bit Length	Defaultvalue	Value Range	Changeable	Visible
From Pluto Node	Unsigned8	0			Pluto 00	0..31	Yes	Yes
IO type	Unsigned8	1			UNUSED	0..114	Yes	Yes
Additional Data Area 31 (Index: 39 -- Length: 2 Byte -- Transfersequence: 0)								
Name of Parameter	Data Type	Byte Offset	Bit Offset	Bit Length	Defaultvalue	Value Range	Changeable	Visible
From Pluto Node	Unsigned8	0			Pluto 00	0..31	Yes	Yes
IO type	Unsigned8	1			UNUSED	0..114	Yes	Yes

Module: Data to Pluto Area 0								
Module Ident Number	0x02000401							
Details	Data to Pluto.							
Order Number	N/A							
Category	03-Data to Pluto							
Software Version	1.0							
Hardware Version	1.0							
Submodule: Data to Pluto Area 0								
Submodule Ident Number	0x02000401							
Details	Data to Pluto.							
Cyclic Output Data							Item consistency	
Name	Data Type	Display as Bits	Length [Bytes]					
Area 0 Bits	Unsigned16	Yes						
Area 0 Register 0	Unsigned16	Yes						
Area 0 Register 1	Unsigned16	Yes						
Enable Area 0 (Index: 40 -- Length: 1 Byte -- Transfersequence: 0)								
Name of Parameter	Data Type	Byte Offset	Bit Offset	Bit Length	Defaultvalue	Value Range	Changeable	Visible
Module usage	Bit	0	0		Enable	0..1	Yes	Yes

Module: Data to Pluto Area 1								
------------------------------	--	--	--	--	--	--	--	--

Module Ident Number	0x02000402							
Details	Data to Pluto.							
Order Number	N/A							
Category	03-Data to Pluto							
Software Version	1.0							
Hardware Version	1.0							
Submodule: Data to Pluto Area 1								
Submodule Ident Number	0x02000402							
Details	Data to Pluto.							
Cyclic Output Data							Item consistency	
Name	Data Type	Display as Bits	Length [Bytes]					
Area 1 Bits	Unsigned16	Yes						
Area 1 Register 0	Unsigned16	Yes						
Area 1 Register 1	Unsigned16	Yes						
Enable Area 1 (Index: 40 -- Length: 1 Byte -- Transfersequence: 0)								
Name of Parameter	Data Type	Byte Offset	Bit Offset	Bit Length	Defaultvalue	Value Range	Changeable	Visible
Module usage	Bit	0	1		Enable	0..1	Yes	Yes

Module: Data to Pluto Area 2								
Module Ident Number	0x02000403							
Details	Data to Pluto.							
Order Number	N/A							
Category	03-Data to Pluto							
Software Version	1.0							
Hardware Version	1.0							
Submodule: Data to Pluto Area 2								
Submodule Ident Number	0x02000403							
Details	Data to Pluto.							
Cyclic Output Data							Item consistency	
Name	Data Type	Display as Bits	Length [Bytes]					
Area 2 Bits	Unsigned16	Yes						
Area 2 Register 0	Unsigned16	Yes						
Area 2 Register 1	Unsigned16	Yes						
Enable Area 2 (Index: 40 -- Length: 1 Byte -- Transfersequence: 0)								
Name of Parameter	Data Type	Byte Offset	Bit Offset	Bit Length	Defaultvalue	Value Range	Changeable	Visible
Module usage	Bit	0	2		Enable	0..1	Yes	Yes

Module: Data to Pluto Area 3								
Module Ident Number	0x02000404							
Details	Data to Pluto.							
Order Number	N/A							
Category	03-Data to Pluto							
Software Version	1.0							
Hardware Version	1.0							
Submodule: Data to Pluto Area 3								
Submodule Ident Number	0x02000404							
Details	Data to Pluto.							
Cyclic Output Data							Item consistency	
Name	Data Type	Display as Bits	Length [Bytes]					
Area 3 Bits	Unsigned16	Yes						

Area 3 Register 0	Unsigned16	Yes						
Area 3 Register 1	Unsigned16	Yes						
Enable Area 3 (Index: 40 -- Length: 1 Byte -- Transfersequence: 0)								
Name of Parameter	Data Type	Byte Offset	Bit Offset	Bit Length	Defaultvalue	Value Range	Changeable	Visible
Module usage	Bit	0	3		Enable	0..1	Yes	Yes

Module: Local Data Request								
Module Ident Number	0x00000501							
Details	Request to Pluto for variable data.							
Order Number	N/A							
Category	04-Local Data Req/Rsp							
Software Version	1.0							
Hardware Version	1.0							
Submodule: Local Data Request								
Submodule Ident Number	0x00000000							
Details	Request to Pluto for variable data.							
Cyclic Output Data							Item consistency	
Name	Data Type	Display as Bits	Length [Bytes]					
Sequence Number	Unsigned16	Yes						
Pluto Node	Unsigned16	Yes						
Data Type	Unsigned16	Yes						
Address	Unsigned16	Yes						
Local Data Request Enable (Index: 41 -- Length: 1 Byte -- Transfersequence: 0)								
Name of Parameter	Data Type	Byte Offset	Bit Offset	Bit Length	Defaultvalue	Value Range	Changeable	Visible
Module usage	Bit	0	0		Enable	0..1	Yes	Yes

Module: Local Data Response								
Module Ident Number	0x00000502							
Details	Response from Pluto for variable data.							
Order Number	N/A							
Category	04-Local Data Req/Rsp							
Software Version	1.0							
Hardware Version	1.0							
Submodule: Local Data Response								
Submodule Ident Number	0x00000000							
Details	Response from Pluto for variable data.							
Cyclic Input Data							Item consistency	
Name	Data Type	Display as Bits	Length [Bytes]					
Sequence Number	Unsigned16	Yes						
Pluto Node	Unsigned16	Yes						
Data Type	Unsigned16	Yes						
Address	Unsigned16	Yes						
Error Code	Unsigned16	Yes						
Data MSW	Unsigned16	Yes						
Data LSW	Unsigned16	Yes						
Local Data Response Enable (Index: 41 -- Length: 1 Byte -- Transfersequence: 0)								
Name of Parameter	Data Type	Byte Offset	Bit Offset	Bit Length	Defaultvalue	Value Range	Changeable	Visible
Module usage	Bit	0	1		Enable	0..1	Yes	Yes

Parameter of Modules

Parameter-ID: IDV_Enable	
Value	Content
0	Disable
1	Enable

Parameter-ID: IDV_GatewayNodeAddress	
Value	Content
0	DIP-Switch Setting
1	Node Address 0
2	Node Address 1
3	Node Address 2
4	Node Address 3
5	Node Address 4
6	Node Address 5
7	Node Address 6
8	Node Address 7
9	Node Address 8
10	Node Address 9
11	Node Address 10
12	Node Address 11
13	Node Address 12
14	Node Address 13
15	Node Address 14
16	Node Address 15

Parameter-ID: IDV_IOPluto	
Value	Content
0	Pluto 00
1	Pluto 01
2	Pluto 02
3	Pluto 03
4	Pluto 04
5	Pluto 05
6	Pluto 06
7	Pluto 07
8	Pluto 08
9	Pluto 09
10	Pluto 10
11	Pluto 11
12	Pluto 12
13	Pluto 13
14	Pluto 14
15	Pluto 15
16	Pluto 16
17	Pluto 17
18	Pluto 18
19	Pluto 19
20	Pluto 20
21	Pluto 21
22	Pluto 22
23	Pluto 23
24	Pluto 24
25	Pluto 25

26	Pluto 26
27	Pluto 27
28	Pluto 28
29	Pluto 29
30	Pluto 30
31	Pluto 31

Parameter-ID: IDV_IOType	
Value	Content
0	UNUSED
1	ToGateway_UserNumber_1
2	ToGateway_UserNumber_2
3	ToGateway_UserNumber_3
4	ToGateway_UserNumber_4
5	ToGateway_UserNumber_5
6	ToGateway_UserNumber_6
7	ToGateway_UserNumber_7
8	ToGateway_UserNumber_8
9	ToGateway_UserNumber_9
10	ToGateway_UserNumber_10
11	ToGateway_UserNumber_11
12	ToGateway_UserNumber_12
13	ToGateway_UserNumber_13
14	ToGateway_UserNumber_14
15	ToGateway_UserNumber_15
16	ToGateway_UserNumber_16
17	ToGateway_UserNumber_17
18	ToGateway_UserNumber_18
19	ToGateway_UserNumber_19
20	ToGateway_UserNumber_20
21	ToGateway_UserNumber_21
22	ToGateway_UserNumber_22
23	ToGateway_UserNumber_23
24	ToGateway_UserNumber_24
25	ToGateway_UserNumber_25
26	ToGateway_UserNumber_26
27	ToGateway_UserNumber_27
28	ToGateway_UserNumber_28
29	ToGateway_UserNumber_29
30	ToGateway_UserNumber_30
31	ToGateway_UserNumber_31
32	ToGateway_UserNumber_32
33	ToGateway_UserNumber_33
34	ToGateway_UserNumber_34
35	ToGateway_UserNumber_35
36	ToGateway_UserNumber_36
37	ToGateway_UserNumber_37
38	ToGateway_UserNumber_38
39	ToGateway_UserNumber_39
40	ToGateway_UserNumber_40
41	ToGateway_UserNumber_41
42	ToGateway_UserNumber_42
43	ToGateway_UserNumber_43
44	ToGateway_UserNumber_44
45	ToGateway_UserNumber_45
46	ToGateway_UserNumber_46
47	ToGateway_UserNumber_47
48	ToGateway_UserNumber_48

49	ToGateway_UserNumber_49
50	ToGateway_UserNumber_50
51	ToGateway_UserNumber_51
52	ToGateway_UserNumber_52
53	ToGateway_UserNumber_53
54	ToGateway_UserNumber_54
55	ToGateway_UserNumber_55
56	ToGateway_UserNumber_56
57	ToGateway_UserNumber_57
58	ToGateway_UserNumber_58
59	ToGateway_UserNumber_59
60	ToGateway_UserNumber_60
61	ToGateway_UserNumber_61
62	ToGateway_UserNumber_62
63	ToGateway_UserNumber_63
64	ToGateway_UserNumber_64
65	ToGateway_UserNumber_65
66	ToGateway_UserNumber_66
67	ToGateway_UserNumber_67
68	ToGateway_UserNumber_68
69	ToGateway_UserNumber_69
70	ToGateway_UserNumber_70
71	ToGateway_UserNumber_71
72	ToGateway_UserNumber_72
73	ToGateway_UserNumber_73
74	ToGateway_UserNumber_74
75	ToGateway_UserNumber_75
76	ToGateway_UserNumber_76
77	ToGateway_UserNumber_77
78	ToGateway_UserNumber_78
79	ToGateway_UserNumber_79
80	ToGateway_UserNumber_80
81	ToGateway_UserNumber_81
82	ToGateway_UserNumber_82
83	ToGateway_UserNumber_83
84	ToGateway_UserNumber_84
85	ToGateway_UserNumber_85
86	ToGateway_UserNumber_86
87	ToGateway_UserNumber_87
88	ToGateway_UserNumber_88
89	ToGateway_UserNumber_89
90	ToGateway_UserNumber_90
91	ToGateway_UserNumber_91
92	ToGateway_UserNumber_92
93	ToGateway_UserNumber_93
94	ToGateway_UserNumber_94
95	ToGateway_UserNumber_95
96	ToGateway_UserNumber_96
97	ToGateway_UserNumber_97
98	ToGateway_UserNumber_98
99	ToGateway_UserNumber_99
100	ToGateway_ErrorCode
101	ToGateway_B46_I20_I47
102	ToGateway_ASi_16_31_Safe
103	ToGateway_ASi_1_3_NonSafe_In
104	ToGateway_ASi_4_7_NonSafe_In
105	ToGateway_ASi_8_11_NonSafe_In
106	ToGateway_ASi_12_15_NonSafe_In
107	ToGateway_ASi_16_19_NonSafe_In

	ToGateway_ASi_20_23_NonSafe_In
109	ToGateway_ASi_24_27_NonSafe_In
110	ToGateway_ASi_28_31_NonSafe_In
111	ToGateway_Global
112	ToGateway_ASi_B42_I20_I47
113	ToGateway_ASi_1_15_Safe
114	ToGateway_D45_I20_I47

Note: This page shows the content of a GSD file transformed into HTML format. In the case of disparity between this and the XML view, the content of the XML file takes precedence.

19 Appendix F, object description Modbus TCP

19.1 Port number

The Modbus TCP server is running on the standard port number 502.

19.2 Unit Identifier

The server will respond on the following “Unit Identifier number” (UI) of “slave address”.

UI	Data	Access function	Access Rule
1 (0x01)	Data to Pluto.	FC01, FC03, FC05, FC06, FC15 and FC16	RW
4 (0x04)	Gateway Configuration.	FC03 and FC16	RW
10 (0x0A)	Data to/from Pluto.	FC23	RW
33 (0x21)	(Data from Pluto, see note below).	FC03	RO
36 (0x24)	Data from Pluto, see note below.	FC01 and FC03	RO

RW is Read/Write access.

RO is Read only access.

Note: The **UI 33** and **UI 36** is the same information but used different type if encoding of 32 bit data.

19.3 Access functions

Each UI can be accessed via different access function codes,

FC	Description	Access Rule
01 (0x01)	Read Coils	Read
03 (0x03)	Read Holding Register	Read
05 (0x05)	Write Coils	Write
06 (0x06)	Write Single Register	Write
15 (0x0E)	Force Multiple Coils	Write
16 (0x10)	Preset Multiple Registers	Write
23 (0x17)	Read/Write Registers	Read/Write

19.4 Data format

An UINT data types occupy one Modbus registers, the data is ordered in the following way:

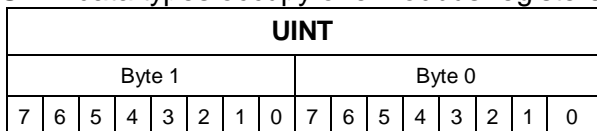

An UDINT data type occupies two Modbus registers, the data is ordered in the following way:

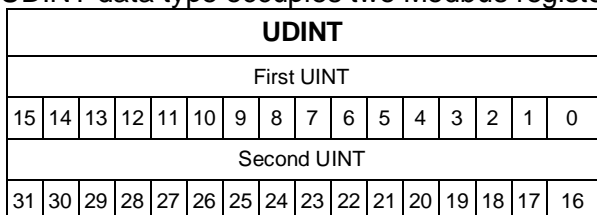

UDINT data for **UI 33**, the data is ordered in the following way:

UDINT															
First UINT															
31	30	29	28	27	26	25	24	23	22	21	20	19	18	17	16
Second UINT															
15	14	13	12	11	10	9	8	7	6	5	4	3	2	1	0

19.5 Data to Pluto

Unit Identifier 1: for read/write data to Pluto system.

Modbus register	Data Name	Data Type	Access	Note
0	Reserved – will not be used	UINT	RW	
1	Reserved – will not be used	UINT	RW	
2	Area 0, Bits	UINT	RW	
3	Area 0, Register 0	UINT	RW	
4	Area 0, Register 1	UINT	RW	
5	Area 1, Bits	UINT	RW	
6	Area 1, Register 0	UINT	RW	
7	Area 1, Register 1	UINT	RW	
8	Area 2, Bits	UINT	RW	
9	Area 2, Register 0	UINT	RW	
10	Area 2, Register 1	UINT	RW	
11	Area 3, Bits	UINT	RW	
12	Area 3, Register 0	UINT	RW	
13	Area 3, Register 1	UINT	RW	

19.6 Gateway Configuration

Unit Identifier 4: to write configuration to the gateway.

Note: This data is common for all connected clients. E.g. valid configuration will be the data written by the last client writing data to this slave address.

Note: For additional data Pluto number and IO-type shall be set to zero if data area is not used.

Modbus register	Data Name	Data Type	Access	Note
0	Reserved – will not be used	UNIT	RW	
1	Enable Data to Pluto (0 = Disabled; 1 = Enabled) - bit 0 – Data To Pluto Area 0 - bit 1 – Data To Pluto Area 1 - bit 2 – Data To Pluto Area 2 - bit 3 – Data To Pluto Area 3	UINT	RW	UINT read/write data is truncated to byte size.
2	Data to Pluto Timeout (ms) 0 = Timeout disabled (default). 1 – 65535 ms.	UINT	RW	
3	Reserved – will not be used	UDINT	RW	
5	Additional Data Area 0	UINT	RW	Format see note below.
6	Additional Data Area 1	UINT	RW	Format see note below.

Modbus register	Data Name	Data Type	Access	Note
7	Additional Data Area 2	UINT	RW	Format see note below.
8	Additional Data Area 3	UINT	RW	Format see note below.
9	Additional Data Area 4	UINT	RW	Format see note below.
10	Additional Data Area 5	UINT	RW	Format see note below.
11	Additional Data Area 6	UINT	RW	Format see note below.
12	Additional Data Area 7	UINT	RW	Format see note below.
13	Additional Data Area 8	UINT	RW	Format see note below.
14	Additional Data Area 9	UINT	RW	Format see note below.
15	Additional Data Area 10	UINT	RW	Format see note below.
16	Additional Data Area 11	UINT	RW	Format see note below.
17	Additional Data Area 12	UINT	RW	Format see note below.
18	Additional Data Area 13	UINT	RW	Format see note below.
19	Additional Data Area 14	UINT	RW	Format see note below.
20	Additional Data Area 15	UINT	RW	Format see note below.
21	Additional Data Area 16	UINT	RW	Format see note below.
22	Additional Data Area 17	UINT	RW	Format see note below.
23	Additional Data Area 18	UINT	RW	Format see note below.
24	Additional Data Area 19	UINT	RW	Format see note below.
25	Additional Data Area 20	UINT	RW	Format see note below.
26	Additional Data Area 21	UINT	RW	Format see note below.
27	Additional Data Area 22	UINT	RW	Format see note below.
28	Additional Data Area 23	UINT	RW	Format see note below.
29	Additional Data Area 24	UINT	RW	Format see note below.
30	Additional Data Area 25	UINT	RW	Format see note below.
31	Additional Data Area 26	UINT	RW	Format see note below.
32	Additional Data Area 27	UINT	RW	Format see note below.
33	Additional Data Area 28	UINT	RW	Format see note below.
34	Additional Data Area 29	UINT	RW	Format see note below.
35	Additional Data Area 30	UINT	RW	Format see note below.
36	Additional Data Area 31	UINT	RW	Format see note below.
37	Data to Pluto Cycle time (ms) 0 – 255 ms, default 100 ms	UINT	RW	UINT read/write data is truncated to byte size.
38	Reserved – will not be used	UINT	RW	
39	Reserved – will not be used	UINT	RW	
40	Reserved – will not be used	UINT	RW	
41	Gateway Node number (0-16) 0 = Read from DIP switch 1 = Gateway node number 0 2 = Gateway node number 1 ... 16 = Gateway node number 15 For more see chapter 6.1.4.1.	UINT	RW	UINT read/write data is truncated to byte size.

The UINT configuration data is allocated as following:

UINT	
Byte 1 (high byte)	Byte 0 (low byte)
Pluto node number, range 0 – 31.	IO-typ, range 0 – 255.

19.7 Data to/from Pluto

Unit Identifier 10: Read global data from Pluto and write data to Pluto

Modbus register	Data Name	Data Type	Access	Note
0	Pluto node status	UDINT	RO	
2	Global data Pluto 0	UDINT	RO	
4	Global data Pluto 1	UDINT	RO	
6	Global data Pluto 2	UDINT	RO	
8	Global data Pluto 3	UDINT	RO	
10	Global data Pluto 4	UDINT	RO	
12	Global data Pluto 5	UDINT	RO	
14	Global data Pluto 6	UDINT	RO	
16	Global data Pluto 7	UDINT	RO	
18	Global data Pluto 8	UDINT	RO	
20	Global data Pluto 9	UDINT	RO	
22	Global data Pluto 10	UDINT	RO	
24	Global data Pluto 11	UDINT	RO	
26	Global data Pluto 12	UDINT	RO	
28	Global data Pluto 13	UDINT	RO	
30	Global data Pluto 14	UDINT	RO	
32	Global data Pluto 15	UDINT	RO	
34	Global data Pluto 16	UDINT	RO	
36	Global data Pluto 17	UDINT	RO	
38	Global data Pluto 18	UDINT	RO	
40	Global data Pluto 19	UDINT	RO	
42	Global data Pluto 20	UDINT	RO	
44	Global data Pluto 21	UDINT	RO	
46	Global data Pluto 22	UDINT	RO	
48	Global data Pluto 23	UDINT	RO	
50	Global data Pluto 24	UDINT	RO	
52	Global data Pluto 25	UDINT	RO	
54	Global data Pluto 26	UDINT	RO	
56	Global data Pluto 27	UDINT	RO	
58	Global data Pluto 28	UDINT	RO	
60	Global data Pluto 29	UDINT	RO	
62	Global data Pluto 30	UDINT	RO	
64	Global data Pluto 31	UDINT	RO	
66	Additional data 0	UDINT	RO	
68	Additional data 1	UDINT	RO	
70	Additional data 2	UDINT	RO	
72	Additional data 3	UDINT	RO	
74	Additional data 4	UDINT	RO	
76	Additional data 5	UDINT	RO	
78	Additional data 6	UDINT	RO	
80	Additional data 7	UDINT	RO	
82	Additional data 8	UDINT	RO	
84	Additional data 9	UDINT	RO	
86	Additional data 10	UDINT	RO	
88	Additional data 11	UDINT	RO	
90	Additional data 12	UDINT	RO	
92	Additional data 13	UDINT	RO	
94	Additional data 14	UDINT	RO	
96	Additional data 15	UDINT	RO	

Modbus register	Data Name	Data Type	Access	Note
98	Additional data 16	UDINT	RO	
100	Additional data 17	UDINT	RO	
102	Additional data 18	UDINT	RO	
104	Additional data 19	UDINT	RO	
106	Additional data 20	UDINT	RO	
108	Additional data 21	UDINT	RO	
110	Additional data 22	UDINT	RO	
112	Additional data 23	UDINT	RO	
114	Additional data 24	UDINT	RO	
116	Additional data 25	UDINT	RO	
118	Additional data 26	UDINT	RO	
120	Additional data 27	UDINT	RO	
122	Additional data 28	UDINT	RO	
124	Additional data 29	UDINT	RO	
126	Additional data 30	UDINT	RO	
128	Additional data 31	UDINT	RO	
130-198	Not used	UDINT		Not mapped
200	Area 0, Bits	UINT	RW	
201	Area 0, Register 0	UINT	RW	
202	Area 0, Register 1	UINT	RW	
203	Area 1, Bits	UINT	RW	
204	Area 1, Register 0	UINT	RW	
205	Area 1, Register 1	UINT	RW	
206	Area 2, Bits	UINT	RW	
207	Area 2, Register 0	UINT	RW	
208	Area 2, Register 1	UINT	RW	
209	Area 3, Bits	UINT	RW	
210	Area 3, Register 0	UINT	RW	
211	Area 3, Register 1	UINT	RW	

19.8 Data from Pluto

Unit Identifier 33 and 36: for read Pluto node status, global data from each Pluto and also additional data from the Pluto system.

Note: Note that **UI 33** and **UI36** has different layout of the UDINT (see 19.4). The **UI33** is implemented for compatibility with the GATE-E2 and new usage shall use the **UI36** with the standard format of UDINT for Modbus TCP (see 19.2).

Note: Only 100 words can be read in one request!

If **more data** is needed divide them in two or more request with selected start/end address in the request. For example a request with start 1 and end 66 will give node status and Pluto global data. A request with start 67 and end 130 will give additional data.

Modbus register	Data Name	Data Type	Access	Note
0	Reserved – will not be used	UINT	RO	
1	Pluto node status	UDINT	RO	
3	Global data Pluto 0	UDINT	RO	

Modbus register	Data Name	Data Type	Access	Note
5	Global data Pluto 1	UDINT	RO	
7	Global data Pluto 2	UDINT	RO	
9	Global data Pluto 3	UDINT	RO	
11	Global data Pluto 4	UDINT	RO	
13	Global data Pluto 5	UDINT	RO	
15	Global data Pluto 6	UDINT	RO	
17	Global data Pluto 7	UDINT	RO	
19	Global data Pluto 8	UDINT	RO	
21	Global data Pluto 9	UDINT	RO	
23	Global data Pluto 10	UDINT	RO	
25	Global data Pluto 11	UDINT	RO	
27	Global data Pluto 12	UDINT	RO	
29	Global data Pluto 13	UDINT	RO	
31	Global data Pluto 14	UDINT	RO	
33	Global data Pluto 15	UDINT	RO	
35	Global data Pluto 16	UDINT	RO	
37	Global data Pluto 17	UDINT	RO	
39	Global data Pluto 18	UDINT	RO	
41	Global data Pluto 19	UDINT	RO	
43	Global data Pluto 20	UDINT	RO	
45	Global data Pluto 21	UDINT	RO	
47	Global data Pluto 22	UDINT	RO	
49	Global data Pluto 23	UDINT	RO	
51	Global data Pluto 24	UDINT	RO	
53	Global data Pluto 25	UDINT	RO	
55	Global data Pluto 26	UDINT	RO	
57	Global data Pluto 27	UDINT	RO	
59	Global data Pluto 28	UDINT	RO	
61	Global data Pluto 29	UDINT	RO	
63	Global data Pluto 30	UDINT	RO	
65	Global data Pluto 31	UDINT	RO	
67	Additional data 0	UDINT	RO	
69	Additional data 1	UDINT	RO	
71	Additional data 2	UDINT	RO	
73	Additional data 3	UDINT	RO	
75	Additional data 4	UDINT	RO	
77	Additional data 5	UDINT	RO	
79	Additional data 6	UDINT	RO	
81	Additional data 7	UDINT	RO	
83	Additional data 8	UDINT	RO	
85	Additional data 9	UDINT	RO	
87	Additional data 10	UDINT	RO	
89	Additional data 11	UDINT	RO	
91	Additional data 12	UDINT	RO	
93	Additional data 13	UDINT	RO	
95	Additional data 14	UDINT	RO	
97	Additional data 15	UDINT	RO	
99	Additional data 16	UDINT	RO	
101	Additional data 17	UDINT	RO	
103	Additional data 18	UDINT	RO	
105	Additional data 19	UDINT	RO	
107	Additional data 20	UDINT	RO	
109	Additional data 21	UDINT	RO	

Modbus register	Data Name	Data Type	Access	Note
111	Additional data 22	UDINT	RO	
113	Additional data 23	UDINT	RO	
115	Additional data 24	UDINT	RO	
117	Additional data 25	UDINT	RO	
119	Additional data 26	UDINT	RO	
121	Additional data 27	UDINT	RO	
123	Additional data 28	UDINT	RO	
125	Additional data 29	UDINT	RO	
127	Additional data 30	UDINT	RO	
129	Additional data 31	UDINT	RO	

Contact information

Australia

ABB Australia Pty Limited
Low Voltage Products
Tel: +61 (0)1300 660 299
Fax: +61 (0)1300 853 138
Mob: +61 (0)401 714 392
E-mail: kenneth.robertson@au.abb.com
Web: www.abbaustralia.com.au

Austria

ABB AB, Jokab Safety
Tel: +43 (0)1 601 09-6204
Fax: +43 (0)1 601 09-8600
E-mail: aleksander.gauza@at.abb.com
Web: www.abb.at

Belgium

ABB N.V.
Tel: +32 27186884
Fax: +32 27186831
E-mail: tech.lp@be.abb.com

Brazil

ABB Ltda
Produtos de Baixa Tensão
ABB Atende: 0800 014 9111
Fax: +55 11 3688-9977
Web: www.abb.com.br

Canada

ABB Inc.
Tel: +1 514 420 3100 Ext 3269
Fax: +1 514 420 3137
Mobile: +1 514 247 4025
E-mail: alan.m.brown@ca.abb.com
Web: www.abb.com

China

ABB (China) Limited
Tel: 86-21-23287948
Telefax: 86-21-23288558
Mobile: 86-186 2182 1159
E-mail: harry-yarong.zhang@cn.abb.com

Czech Republic

ABB AB, Jokab Safety
Tel: +420 543 145 482
Fax: +420 543 243 489
E-mail: premysl.broz@cz.abb.com
Web: www.abb.cz

Denmark

JOKAB SAFETY DK A/S
Tel: +45 44 34 14 54
Fax: +45 44 99 14 54
E-mail: info@jokabsafety.dk
Web: www.jokabsafety.dk

ABB A/S

Tel: +45 4450 4450
Fax: +45 4359 5920
E-mail: ordre.komp@dk.abb.com
Web: www.abb.dk

Finland

ABB Oy
Web: www.abb.fi

France

ABB France
Division Produits Basse Tension
Tel: 0825 38 63 55
Fax: 0825 87 09 26
Web: www.abb.com

Germany

ABB STOTZ-KONTAKT GmbH
Tel: +49 (0) 7424-95865-0
Fax: +49 (0) 7424-95865-99
E-mail: buero.spaichingen@de.abb.com
Web: www.jokabsafety.com

Greece

ABB SA
Tel: +30 210.28.91.900
Fax: +30 210.28.91.999
E-mail: dimitris.voulgaris@gr.abb.com
nikos.makrakos@gr.abb.com
Web: www.abb.com

Ireland

ABB Ltd.
Tel +353 1 4057 381
Fax: +353 1 4057 312
Mobile: +353 86 2532891
E-mail: derek.kelly@ie.abb.com

Israel

ABB Technologies Ltd.
Tel: +972 4 851-9204
Mobile: +972 52 485-6284
E-mail: contact@il.abb.com
Web: www.abb.co.il

Italy

ABB S.p.A.
Tel. +39 02 2414.1
Fax +39 02 2414.2330
Web: www.abb.it

Korea

ABB KOREA
Low-voltage Product
Tel: +82 2 528 3177
Fax: +82 2 528 2350
Web: www.jokabsafety.co.kr

Malaysia

ABB Malaysia
Tel: +60356284888 4282
E-mail: chang-sheng.saw@my.abb.com

Netherlands

ABB b.v.
Tel: +31 (0) 10 - 4078 947
Fax: +31 (0) 10 - 4078 090
E-mail: info.lowvoltageproducts@nl.abb.com
Web: www.abb.nl

Norway

ABB AS
Tel: +47 03500
Fax: +47 32858021
Mobile: +47 40918930
E-mail: Lars-Erik.Arvesen@no.abb.com
Web: www.abb.no

Poland

ABB Sp. z.o.o
Tel: +48 728 401 403
Fax: 22 220 22 23
E-mail: adam.rasinski@pl.abb.com,
safety@pl.abb.com
Web: www.abb.pl

Portugal

Asea Brown Boveri S.A.
Low Voltage Products - Baixa Tensão
Tel: +35 214 256 000
Fax: +35 214 256 390
Web: www.abb.es

Slovenia

ABB d.o.o.
Tel: +386 1 2445 455
Fax: +386 1 2445 490
E-mail: aljosa.dobersek@si.abb.com

Spain

Asea Brown Boveri S.A.
Tel: +34 93 4842121
Fax: +34 93 484 21 90
Web: www.abb.es

South Africa

ABB
Tel: +27 10 202 5906
Fax: +27 11 579 8203
Mobile: +27 82 500 7990
E-mail: Hendrik.Spies@za.abb.com

Sweden

ABB AB, Jokab Safety
Varlabergsvägen 11
SE-434 39 Kungsbacka
Tel: +46 21 32 50 00
Fax: +46 40 67 15 601
E-mail: support.jokabsafety@se.abb.com
Web: www.abb.com/jokabsafety

Switzerland

ABB Schweiz AG
Industrie- und Gebäudeautomation
Tel: +41 58 586 00 00
Fax: +41 58 586 06 01
E-mail: industrieautomation@ch.abb.com
Web: www.abb.ch

Turkey

ABB Elektrik Sanayi A.Ş
Tel: 0216 528 22 00
Fax: 0216 365 29 44

United Kingdom

ABB Ltd/JOKAB SAFETY UK
Tel: +44 (0) 2476 368500
Fax: +44 (0) 2476 368401
E-mail: orders.lvp@gb.abb.com
Web: www.jokabsafety.com

USA/Mexico

ABB Jokab Safety North America
Tel: +1 519 735 1055
Fax: +1 519 7351299
E-mail: jokabnaorderentry@us.abb.com
Web: www.jokabsafetyna.com